INSTALLATION INSTRUCTIONS

Full Flow Modulating Economizer with Exhaust for Building Applications

Models: ECON-WD5/ECON-DB5



For Use with Bard Single Stage Wall Mount Air Conditioner and Heat Pump Models:

W42AC, W48AC, W60AC, W72AC
W42HB, W48HB, W60HB, W72HB

NOTE: *These instructions are written to cover field-installed economizers, but are also included with factory-installed economizers. For factory-installed economizers, all portions addressing “installation” are for reference only.*



Climate Control Solutions

Bard Manufacturing Company, Inc.
Bryan, Ohio 43506
www.bardhvac.com

Manual: 2100-697
Supersedes: **NEW**
Date: 6-13-19

CONTENTS

General Information	3
Economizer Model Nomenclature	3
Unpacking	3
General	3
Economizer Features.....	3
Description	3
Models	3

Installation of Field-Installed ECON-WD5/ ECON-DB5.....	4
Basic Installation.....	4
Blade Adjustment for Desired Ventilation Air	10
Start-Up/Checkout Procedures	11
Enthalpy Settings	15
Economizer Sequence of Operation	16
Economizer Operation for Single Stage	18
S, Y and Z Option Economizer Sequence of Operation – Balanced Climate Mode.....	19
Economizer Operation – Balanced Climate Mode ..	20

Tables	
Table 1 System Setup Menu Levels	12
Table 2 Advanced Setup Menu Levels.....	12
Table 3 Setpoints Menu Levels.....	13
Table 4 H Series Setpoints Menu Levels	13
Table 5 Checkout Menu Levels.....	13
Table 6 Status Menu Levels.....	14
Table 7 Alarm Examples	14
Table 8 Unit Operation with S (Part Flow), Y and Z (Full Flow) Economizer Options ...	19

Graphs	
Graph 1 W42AC ECON-E & WD Ventilation Delivery.....	24
Graph 2 W48AC ECON-E & WD Ventilation Delivery.....	24
Graph 3 W60AC ECON-E & WD Ventilation Delivery.....	25
Graph 4 W72AC ECON-E & WD Ventilation Delivery.....	25

Figures	
Figure 1 Disconnect Power	4
Figure 2 Remove Side Grilles	4
Figure 3 Remove Blower Door, Control Panel and Condenser Grille	4
Figure 4 Remove Blank Off Plates (Both Sides)....	5
Figure 5 Remove Exhaust Blank Off Plate	5
Figure 6 Remove Air Filters and Low Voltage Control Panel Cover.....	5
Figure 7 Install 910-2063 Control Board Assembly	5
Figure 8 Install Economizer	6
Figure 9 Control Plug Centered in Plug Access Opening	6
Figure 10 Connect Economizer Power Plug to Control Panel Plug	6
Figure 11 Install Indoor Mixed Air Sensor Assembly	6
Figure 12 Route Orange Mixed Air Sensor Wires....	7
Figure 13 Secure Sensor Wires with Ladder Ties	7
Figure 14 Connect Mixed Air Sensor Plug.....	7
Figure 15 Enthalpy Sensor Assembly Installation ...	7
Figure 16 Temperature Only Sensor Assembly Installation	7
Figure 17 Route Wires and Secure with Ties	8
Figure 18 Route Cable Through Control Panel Bushing	8
Figure 19 Route Cable and Connect to Red and Black Wires	8
Figure 20 Wiring Connections Completed	8
Figure 21 Release the Exhaust Blade.....	9
Figure 22 Exhaust Blade and Latch	9
Figure 23 Install Intake Sealing Frame and Lower Block Off Plates	9
Figure 24 Install Mist Filters.....	9
Figure 25 Install Bug Screen and Gaskets	10
Figure 26 JADE™ Economizer Controller	11
Figure 27 Required Control Connections for ECON-**5 with Air Conditioners	16
Figure 28 Required Control Connections for ECON-**5 with Heat Pumps	17
Figure 29 100% Airflow	18
Figure 30 Mixed Airflow Path	18
Figure 31 Call for Compressor or Fan Only with Ventilation Off	19
Figure 32 CO ₂ Sensor Default and Final Settings Bard Part #8403-067 CO ₂ Controller ...	23
Figure 33 Wiring Diagram – Enthalpy Sensor	26
Figure 34 Wiring Diagram – Temperature Only Sensor	27

Economizer with Exhaust Model Nomenclature

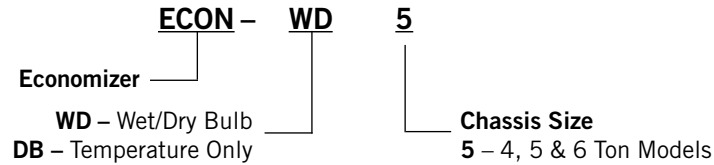

Unpacking

Upon receipt of the equipment be sure to compare the model number found on the shipping label with the accessory identification information on the ordering and shipping document to verify that the correct accessory has been shipped.

Inspect the carton housing of each ventilator as it is received, and before signing the freight bill, verify that all items have been received and that there is no visible damage (check parts list below). Note any shortages or damage on all copies of the freight bill. The receiving party must contact the last carrier immediately, preferably in writing, requesting inspection by the carrier's agent. Concealed damage not discovered until after loading must be reported to the carrier within 15 days of its receipt.

General

The economizer should only be installed by a trained heating and air conditioning technician. These instructions serve as a guide to the technician installing the ventilator package. They are not intended as a step-by-step procedure with which the mechanically inclined owner can install the package.

The economizer housing is shipped in one carton which contains the electrical harness, miscellaneous hardware and installation instructions.

Economizer kit includes:

- (1) ECON-WD5 full flow economizer
- (1) 1-910-1980 sensor assembly (ECON-WD5)
- (1) 1-910-1898E sensor assembly (ECON-DB5)
- (1) 910-2063 economizer control board assembly
- (2) 7003-084 mist filters
- (1) 7003-083 exhaust bug screen
- (2) 1913-002-0808 8-1/2" foam strips
- (4) 1913-002-0708 7-1/2" foam strips
- (2) 539-405 intake sealing frames
- (2) 543-223 lower block off plates
- (1) 7950-12 push mount cable tie
- (8) 7950-004 cable tie
- (28) #10-16x1/2 screws
- (4) #8-18x3/8 pan head screws
- (1) 2100-697 installation instructions

Economizer Features

- One piece construction – easy to install.
- Exhaust air damper – built in with positive closed position. Provides exhaust air capability to prevent pressurization of tight buildings.
- Actuator motor – 24 volt, power open, spring return with built in torque limiting switch.
- JADE™ controller provides nearly limitless customization on a solid, intuitive electronic platform.
- Proportioning-type control for maximum “free” cooling economy and comfort with up to 100% outside air.
- Enthalpy or temperature only sensor to monitor outdoor air conditions.
- Minimum Ventilation Position available for required ventilation of occupants or dilution of pollutants.
- Mixed air sensor to monitor outdoor and return air to automatically modulate damper position.

Description

The ECON-WD5 and ECON-DB5 ventilators are designed to be used with the specific models with "letter" revision codes as designated on the front page of this installation instructions manual.

The economizer is an electromechanical vent system designed to provide fresh air to meet indoor air quality standards.

Models

When installed in the models listed on the front page, ECON-WD5 and ECON-DB5 provide built-in exhaust provisions. When the damper blade opens to bring fresh air in, the damper also opens an exhaust relief. The exhaust air will flow into the condenser section of the unit. The condenser fan will help draw exhaust air out when it is operating with compressor in cooling or heat pump mode.

INSTALLATION OF FIELD-INSTALLED ECON-WD5/ECON-DB5

Basic Installation

WARNING

Electrical shock hazard.
Disconnect remote electrical power supply or supplies before servicing.
Failure to do so could result in electric shock or death.

WARNING

Exposed moving parts.
Disconnect electrical power before servicing.
Failure to do so could result in severe injury or amputation.

CAUTION

Cut hazard.
Wear gloves to avoid contact with sharp edges.
Failure to do so could result in personal injury.

Disconnect all power to unit (see Figure 1).

FIGURE 1
Disconnect Power



Remove both side grilles (see Figure 2).

FIGURE 2
Remove Side Grilles



Remove upper blower door, outer control panel cover and front (lower) condenser grille (see Figure 3).

FIGURE 3
Remove Blower Door, Outer Control Panel Cover and Condenser Grille

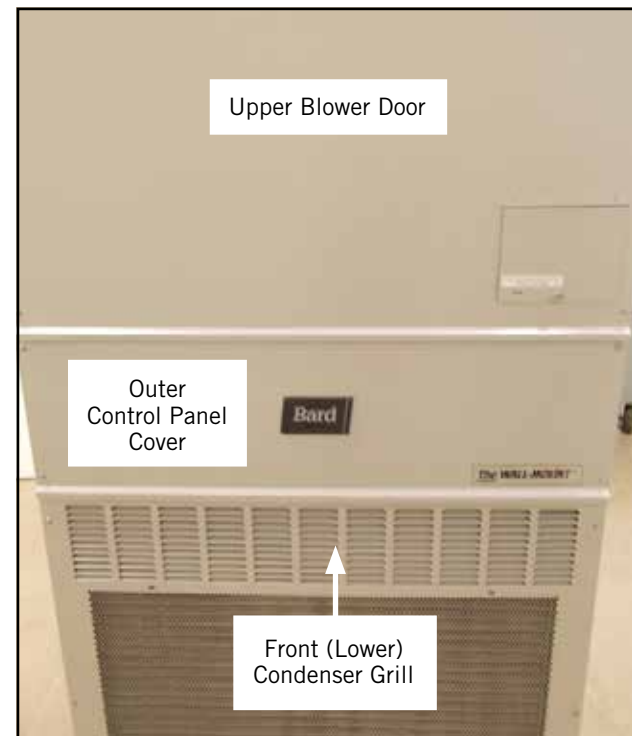

Remove blank off plates (both sides) and discard (see Figure 4).

FIGURE 4
Remove Blank Off Plates (Both Sides)



Remove exhaust blank off plate through return or through side intake openings and discard (see Figure 5).

FIGURE 5
Remove Exhaust Blank Off Plate

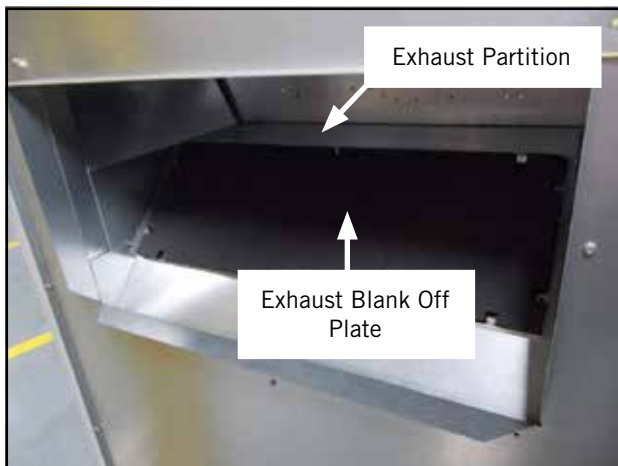

Remove both air filters and the low voltage inner control panel cover (see Figure 6).

FIGURE 6
Remove Air Filters and Low Voltage Control Panel Cover

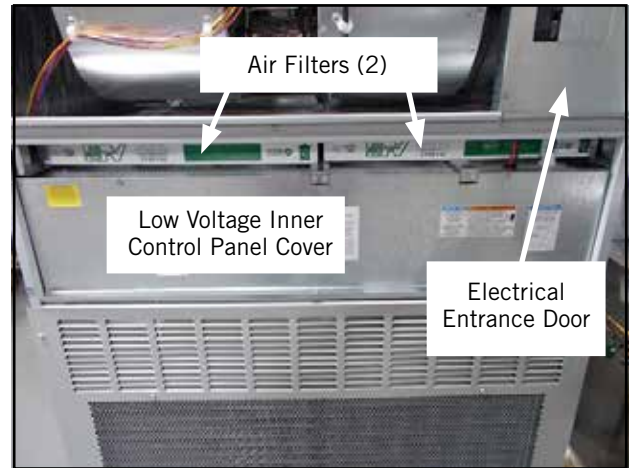

Install the 910-2063 control board assembly on the left side of the control panel using four (4) #10 x 1/2 screws (provided) as shown in Figure 7.

Snap the four wire connector into the opening next to the low voltage box. Plug the 12 pin male connector into the female plug in the low voltage box.

Remove wire channel cover and route four pin connector mixed air sensor and outdoor sensor wires inside channel; mixed air sensor and outdoor sensor wires will be connected later.

FIGURE 7
Install 910-2063 Control Board Assembly

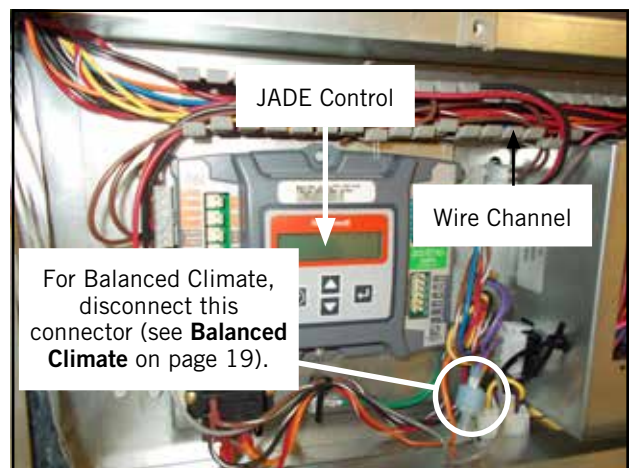

Before installing the economizer, remove economizer from packaging and verify there is no damage. Install the economizer as shown in Figure 8.

Set economizer on the exhaust partition (see Figure 5 on page 5) and slide in until flush with the side of the wall mount.

FIGURE 8
Install Economizer



When the economizer is fully installed, the control plug should be centered in the plug access opening on the front panel of the economizer as shown in Figure 9.

FIGURE 9
Control Plug Centered in Plug Access Opening



From the front, through the filter opening, plug the economizer power plug into the control panel plug (see Figure 10).

IMPORTANT: Sharp edges--PPE required.

FIGURE 10
Connect Economizer Power Plug to Control Panel Plug

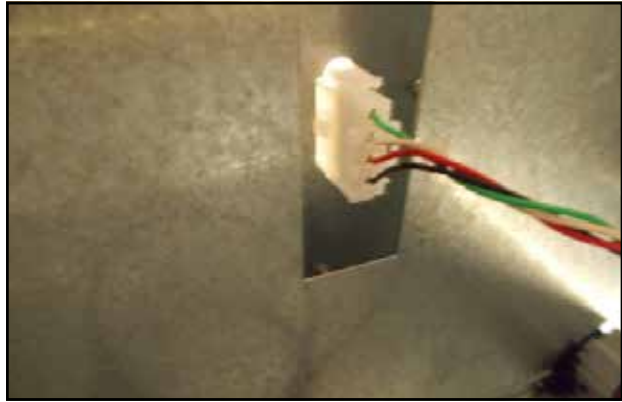

Install the indoor mixed air sensor assembly in the location shown in Figure 11, just to the right of the indoor blower. Use two (2) #10-16x1/2 screws (supplied) to mount the sensor.

FIGURE 11
Install Indoor Mixed Air Sensor Assembly



Route the orange mixed air sensor wires up through the control panel, circuit breaker panel and blower partition as shown in Figure 12.

FIGURE 12
Route Orange Mixed Air Sensor Wires



Secure wires with provided ladder ties (see Figure 13).

FIGURE 13
Secure Sensor Wires with Ladder Ties



Connect sensor plug as shown in Figure 14.

FIGURE 14
Connect Mixed Air Sensor Plug



Install the 910-1980 enthalpy sensor assembly (Figure 15) or 910-1898E temperature only sensor (Figure 16) using two (2) #10-16x1/2 screws (supplied). Fasten cable to the back with one (1) provided push wire tie.

FIGURE 15
Enthalpy Sensor Assembly Installation

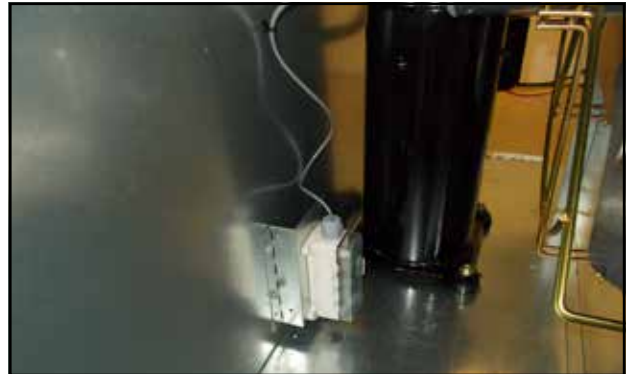

FIGURE 16
Temperature Only Sensor Assembly Installation



Route wires over the top of the outdoor fan motor up through the condenser partition wire bushing as shown in Figure 17. Secure cable with provided ladder ties.

FIGURE 17
Route Wires and Secure with Ties



Route the cable up through the control panel bushing and secure with provided ladder tie (see Figure 18).

FIGURE 18
Route Cable Through Control Panel Bushing

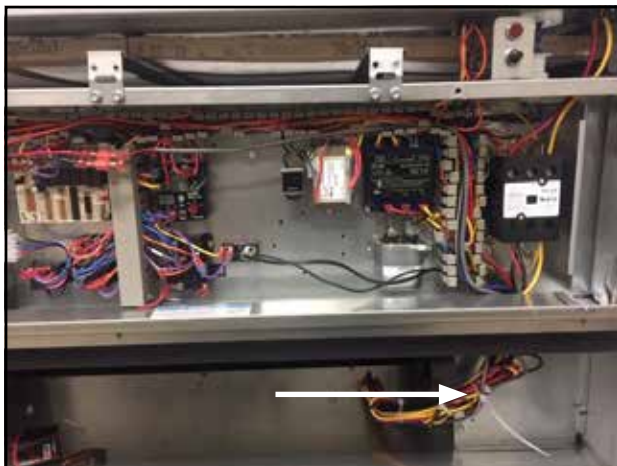

Route the cable into the wire channel (cover removed earlier) and connect to the red and black wires from the JADE™ controller (see Figure 19).

FIGURE 19
Route Cable and Connect to Red and Black Wires



Re-install wire channel covers; make sure all wires are contained inside the channel as shown in Figure 20.

Install the electrical entrance door and upper blower door.

FIGURE 20
Wiring Connections Completed

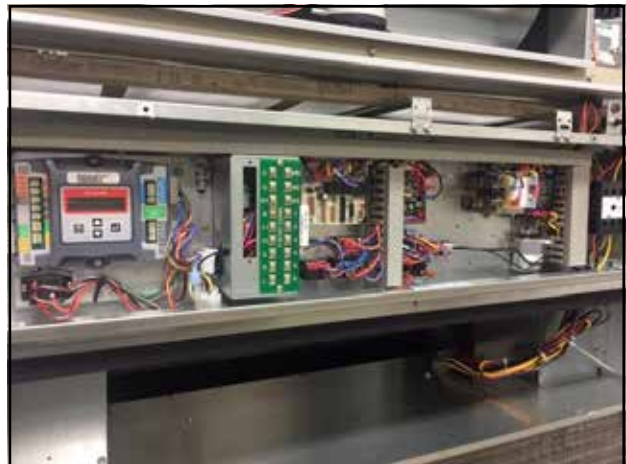

The ECON-WD5 exhaust blade is fixed in the shipping position by the latch located on the bottom of the blade (see Figure 21). Access can be made through the return air opening or through the opening under the economizer. Turning the latch 1/4 turn will release the blade.

FIGURE 21
Release the Exhaust Blade



Make sure the blade seats correctly over the exhaust opening and that the latch is as shown in Figure 22.

FIGURE 22
Exhaust Blade and Latch



Install the 539-405 intake sealing frame and the 543-223 lower block off plates (both sides) as shown in Figure 23. Install two (2) 1913-002-0708 7-1/2" foam gaskets below the intake sealing frame (both sides).

FIGURE 23
Install Intake Sealing Frame and Lower Block Off Plates

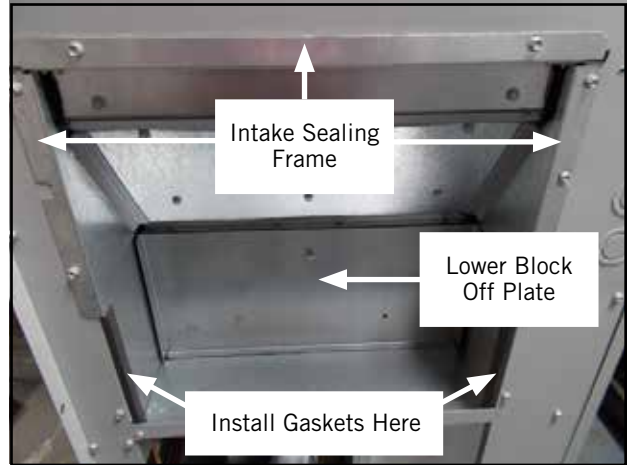

Install 7003-084 mist filters on both sides (see Figure 24). Then re-install the side grilles removed earlier.

FIGURE 24
Install Mist Filters



Install the 7003-083 exhaust bug screen (see Figure 25). Install two (2) 1913-002-0808 8-1/2" foam gaskets to sides of cabinet. Re-install front lower (condenser) grille.

FIGURE 25
Install Bug Screen and Gaskets

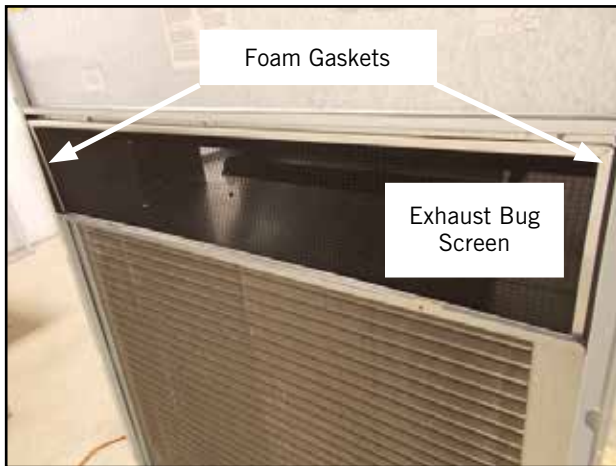

Install both filters, then re-install the inner control panel, outer control panel and upper blower door.

Restore power to unit.

Refer to Start-Up/Checkout Procedures.

Blade Adjustment for Desired Ventilator Air

The amount of ventilation air supplied by the commercial room ventilator is dependant on four factors.

1. Return air duct static pressure drop.
2. Supply air duct static pressure drop.
3. Indoor blower motor speed.
4. Damper blade open position setting.

Refer to the appropriate graph on pages 24 and 25 to determine minimum blade position settings.

START-UP/CHECKOUT PROCEDURES

JADE™ ECONOMIZER CONTROLLER

W7220 controller offers unparalleled flexibility and expansion in a dependable and solid electronic platform.

- Multiple economizer applications from one controller.
- Nearly limitless customization of setpoints.
- Internal checkout menu provides fast performance assessment.
- Alarms menu provides assistance in troubleshooting.

Memory: User-defined setpoints remain in non-volatile flash memory regardless of electrical outage duration. Control voltage below 18V may cause erratic performance.

FIGURE 26
JADE™ Economizer Controller

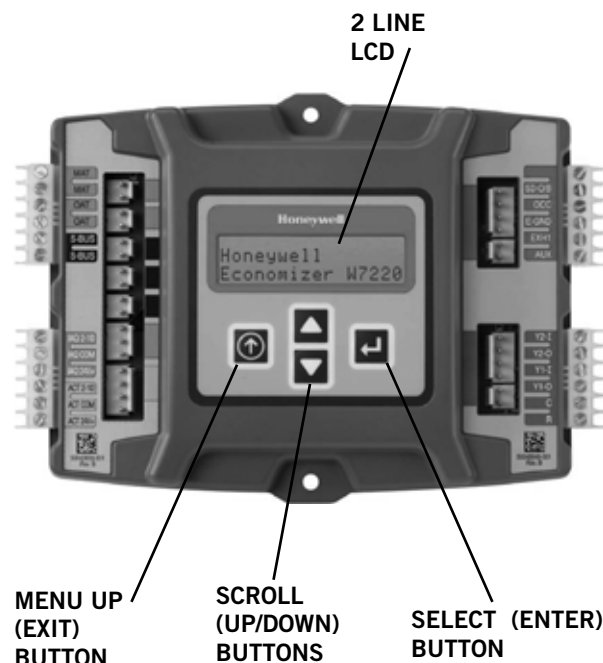

From the factory, the JADE™ economizer controller has been preset with “default” values that were pre-determined as optimum for equipment buildings, and these are shown in Tables 1 – 3. However, it is important to review and/or customize these operational values per owner specifications in order to guarantee satisfactory performance.

If ECON-S* is installed in an H Series unit, the "default" settings for "DRYBLB SET" and "MIN POS"

will need to be changed to the values listed in Table 4 (see page 13).

The installing contractor can easily access the JADE™ programming by the integral keypad and LCD display.

There are six (6) basic MENU categories to navigate:

1. **STATUS** – provides real-time access to sensor input, damper and equipment operation.
2. **SETPOINTS** – customizable operational parameters.
3. **SYSTEM SETUP** – customizable application programming (see Review/Customize System Setup).
4. **ADVANCED SETUP** – further application and operational options.
5. **CHECKOUT** – instantly activate and verify economizer functions.
6. **ALARMS** – displays alarms and pinpoints problem areas.

Review/Customize System Setup

Before being placed in service, the JADE™ economizer controller programming should be reviewed/customized through the following steps:

1. **SYSTEM SETUP:** from the main screen, press the **SCROLL (UP/DOWN) BUTTONS** to navigate through the six (6) basic menu items to the **SYSTEM SETUP** menu.
 - Push the **SELECT (ENTER) BUTTON** to choose the **SYSTEM SETUP** menu.
 - Navigate through the multiple levels of **SYSTEM SETUP** by pushing the **SCROLL (UP/DOWN) BUTTONS**.
 - To change a specific parameter in the **SYSTEM SETUP** menu, press the **SELECT (ENTER) BUTTON** to display its current value. Press the **SCROLL (UP/DOWN) BUTTONS** to change or increase/decrease value. Press the **SELECT (ENTER) BUTTON** to save the new customized value—“CHANGE STORED” will be displayed. Press the **SELECT (ENTER) BUTTON** again to return to current menu parameter.
 - For specific **SYSTEM SETUP** level information, refer to **Table 1**.

NOTE: During an extended level of inactivity, the display of the JADE™ economizer controller will begin to automatically scroll through the various levels of the STATUS menu as a screensaver. Each level will stay for approximately 5 seconds before changing to the next level.

TABLE 1
System Setup Menu Levels

Menu Level	Default Value	Range	Notes
INSTALL	01/01/10		Display Order = MM/DD/YY Setting Order = DD/MM/YY
UNITS DEG	°F	°F / °C	Sets controller to read in either measurements
EQUIPMENT	HP(B)	HP	Heat Pump HP * CONV = A/C
AUX IN	HP(B)	HP(O) HP(B)	Energize on Cool * Energize on Heat
FAN SPEED	1 Speed	1 Speed 2 Speed	
FAN CFM	5000	100 to 15000	Not applicable
AUX OUT	EXH2	NONE ERV EXH2 SYS	Product can be used to signal other devices
OCC	INPUT	INPUT or ALWAYS	INPUT is for dedicated OCC signal, ALWAYS is for all other situations
FACTORY DEFAULT	NO	YES or NO	Resets to factory defaults if changed to YES

* In SYS SETUP, the correct Equipment setting is HP and for the AUX2 IN is HP (B) in all applications. This is correct for both air conditioner and heat pump equipment in order to have correct operating sequences for the economizers. DO NOT change to CONV = A/C setting just because the equipment is an air conditioner and not a heat pump.

2. **ADVANCED SETUP:** from the main screen, press the **SCROLL (UP/DOWN) BUTTONS** to navigate through the six (6) basic menu items to the **ADVANCED SETUP** menu.

- Push the **SELECT (ENTER) BUTTON** to choose the **ADVANCED SETUP** menu.
- Navigate through the multiple levels of **ADVANCED SETUP** by pushing the **SCROLL (UP/DOWN) BUTTONS**.
- To change a specific parameter in the **ADVANCED SETUP** menu, press the **SELECT (ENTER) BUTTON** to display its current value. Press the **SCROLL (UP/DOWN) BUTTONS** to change or increase/decrease value. Press the **SELECT (ENTER) BUTTON** to save the new customized value—“CHANGE STORED” will be displayed. Press the **SELECT (ENTER) BUTTON** again to return to current menu parameter.
- For specific **ADVANCED SETUP** level information, refer to **Table 2**.

TABLE 2
Advanced Setup Menu Levels

Menu Level	Default Value	Range	Notes
MA LOW SET	45°F	35-55°	Temp to activate freeze protection — Close Damper
FREEZE POS	CLO	CLO or MIN	Damper position upon freeze protection
STG3 DLY	15 MIN	0 to 4.0h or OFF	Delay for 3rd Stage Cooling – allows for 3 stages of cooling, one stage for econ & two stages for compressor
DMPR POS	CLO	CLO or OPN	Where damper goes upon shutdown signal
MA T CAL	0.0°F	+/-2.5°F from actual reading	Mixed Air Sensor temperature calibration
OA T CAL	0.0°F	+/-2.5°F from actual reading	Outdoor Air Sensor temperature calibration
OAS H CAL	0%	+/-10% from actual reading	Outdoor Air Humidity Sensor calibration for economizers using temp/humidity sensor

3. **SETPOINTS:** from the main screen, press the **SCROLL (UP/DOWN) BUTTONS** to navigate through the six (6) basic menu items to the **SETPOINTS** menu.

- Push the **SELECT (ENTER) BUTTON** to choose the **SETPOINTS** menu.
- Navigate through the multiple levels of **SETPOINTS** by pushing the **SCROLL (UP/DOWN) BUTTONS**.
- To change a specific parameter in the **SETPOINTS** menu, press the **SELECT (ENTER) BUTTON** to display its current value. Press the **SCROLL (UP/DOWN) BUTTONS** to change or increase/decrease value. Press the **SELECT (ENTER) BUTTON** to save the new customized value—“CHANGE STORED” will be displayed. Press the **SELECT (ENTER) BUTTON** again to return to current menu parameter.
- For specific **SETPOINTS** level information, refer to **Table 3**.
- For H Series unit **SETPOINTS** level information, refer to **Table 4**.

TABLE 3
Setpoints Menu Levels

Menu Level	Default Value	Range	Notes
MAT SET	53°F	38°F to 65°F	Mixed Air Temperature setpoint at which the economizer damper will begin to modulate to maintain setting
LOW T LOCK	0°F	-45°F to 80°F	Low outdoor ambient temperature for compressor lockout
DRYBLB SET	60°F	48°F to 80°F	Maximum outdoor temperature setting for “free” economizer cooling
ENTH CURVE	ES3	ES1, ES2, ES3, ES4 or ES5	Enthalpy boundary “curves” for economizers using temp/humidity sensor, see “Enthalpy Settings” explanation
MIN POS	2V	2 to 10 VDC	Actuator voltage for Minimum Position – see <i>Minimum Position Note</i>
EXH1	50%	0 to 100%	Setpoint for damper if exhaust fan is powered by economizer
EXH2	6%	0 to 100%	Setpoint for AUX output signal
DCV SET (See NOTE under Table 7 on page 14)	1100	500 to 2000	Displays only if a CO ₂ sensor is connected. Setpoint for Demand Control Ventilation of space. Above the setpoint, the OA dampers will modulate open to bring in additional OA to maintain a space ppm level below the setpoint.

TABLE 4
H Series Setpoints Menu Levels*

Menu Level	Default Value	Range	Notes
MAT SET	53°F	38°F to 65°F	Mixed Air Temperature setpoint at which the economizer damper will begin to modulate to maintain setting
LOW T LOCK	0°F	-45°F to 80°F	Low outdoor ambient temperature for compressor lockout
DRYBLB SET	70°F	48°F to 80°F	Maximum outdoor temperature setting for “free” economizer cooling
ENTH CURVE	ES3	ES1, ES2, ES3, ES4 or ES5	Enthalpy boundary “curves” for economizers using temp/humidity sensor, see “Enthalpy Settings” explanation
MIN POS	10V	2 to 10 VDC	Actuator voltage for Minimum Position – see <i>Minimum Position Note</i>
EXH1	50%	0 to 100%	Setpoint for damper if exhaust fan is powered by economizer
EXH2	6%	0 to 100%	Setpoint for AUX output signal

* For DRYBLB SET and MIN POS, change default setting to value shown

MINIMUM POSITION NOTE: Minimum position setting has been preset to 10V which when connected to MC4002 Lead/Lag Controller System will allow economizer to drive wide open per emergency ventilation strategy as detailed in MC4002 Instructions. This may require resetting to a lower value per job specifications.

4. **CHECKOUT:** from the main screen, press the **SCROLL (UP/DOWN) BUTTONS** to navigate through the six (6) basic menu items to the **CHECKOUT** menu.

- Push the **SELECT (ENTER) BUTTON** to choose the **CHECKOUT** menu.
- Navigate through the multiple levels of **CHECKOUT** by pushing the **SCROLL (UP/DOWN) BUTTONS**.
- To perform a specific test in the **CHECKOUT** menu, press the **SELECT (ENTER) BUTTON** to choose a particular exercise, “**RUN?**” will appear. Press the **SELECT (ENTER) BUTTON** again to activate this exercise. After a short pause, “**IN PROGRESS**” will appear as the test activates. “**DONE**” will display after the test is complete. Press the **MENU UP (EXIT) BUTTON** to end the test and/or turn off the activated relay.
- For specific **CHECKOUT** level information, refer to **Table 5**.

NOTE: **CHECKOUT** functions bypass the normal 5-minute delay for compressor protection. Be sure to allow for enough time to pass between tests so the compressor is not damaged from extreme short-cycling.

TABLE 5
Checkout Menu Levels

Menu Level	Notes
DAMPER VMIN-HS	Positions damper to the minimum amount of opening allowed by actuator
DAMPER VMAX-HS	Opens damper to the MIN POS level indicated in the SETPOINTS menu. See <i>Minimum Position Note</i> above.
DAMPER OPEN	Forces damper to full open position, energizes exhaust contacts
DAMPER CLOSE	Positions damper to completely closed position
CONNECT Y1-O	Forces Y1-OUTPUT to compressor
CONNECT Y2-O	Forces Y2-OUTPUT to compressor
CONNECT AUX	Depending upon AUX OUT setting from SETUP menu: NONE – no action ERV – 24VAC out for ERV & NOT Economizer SYS – 24VAC out for alarm

NOTE: Economizer assembly should be ready to put into service. At any point during operation, in economizer mode or idle, real-time information from sensors and integral components can be accessed from the **STATUS** menu.

5. **STATUS:** from the main screen, press the **SCROLL (UP/DOWN) BUTTONS** to navigate through the six (6) basic menu items to the **STATUS** menu.

- Push the **SELECT (ENTER) BUTTON** to choose the **STATUS** menu.
- Navigate through the multiple levels of **STATUS** by pushing the **SCROLL (UP/DOWN) BUTTONS**.
- As the **STATUS** menu simply gives input/output information in real-time, there is no way to change or otherwise alter the displayed criteria. It is simply a window into the operation of the economizer controller.
- For specific **STATUS** level information, refer to **Table 6**.

NOTE: Upon power-up (or after power failure or low voltage condition), the controller will begin a 5-minute time delay before enabling mechanical cooling.

TABLE 6
Status Menu Levels

Menu Level	Default Value	Notes
ECON AVAIL	YES/NO	Indicates if conditions are favorable for economizing
ECONOMIZING	YES/NO	Indicates if economizer is actively economizing
OCCUPIED	YES/NO	Indicates if dedicated 24V occupied signal is being received on terminal OCC
HEAT PUMP	COOL/HEAT	Displays actual compressor use if in HEAT PUMP mode
COOL Y1-IN	ON/OFF	Indicates if 24V signal is being received on terminal Y1-I
COOL Y1-OUT	ON/OFF	Displays if controller is actively calling for mechanical compressor cooling (24V on Y1-O)
COOL Y2-IN	ON/OFF	Indicates if 24V signal is being received on terminal Y2-I
COOL Y2-OUT	ON/OFF	Displays if controller is actively calling for Stg. 2 cooling (24V on Y2-O)
MA TEMP	0° to 140°F	Current mixed air temp
OA TEMP	-40° to 140°F	Current outdoor air temp
OA HUM	0% to 100%	Current outdoor air humidity for economizers using temp/humidity sensor
DAMPER OUT	2.0 to 10.0	Displays voltage to actuator
ACT POS	0 to 100%	Current % of opening
ACT COUNT	N/A	Current count of actuator cycles from installation
ACTUATOR OK	YES/NO	Indicates potential fault
EXH1 OUT	ON/OFF	Output of EXH1 Terminal
MECH COOL ON	0, 1, or 2	Stages of mechanical cooling currently active

NOTE: If there are any potential problems recognized by the economizer controller, it may be registered in the form of an alarm in the **ALARM(S)** menu. If there is a period of inactivity AND there is an alarm registering, the controller will randomly scroll through the **ALARM(S)** menu items as a screensaver.

ALARM(S): from the main screen, press the **SCROLL (UP/DOWN) BUTTONS** to navigate through the six (6) basic menu items to the **ALARM(S)** menu.

- Push the **SELECT (ENTER) BUTTON** to choose the **ALARM(S)** menu.
- Navigate through the current alarms in **ALARM(S)** by pushing the **SCROLL (UP/DOWN) BUTTONS**.
- Once the alarm has been identified, and the cause has been removed (e.g., replaced faulty sensor), the alarm may erase itself. If a manual alarm-erasing is required, it can be cleared from the display by navigating to the desired alarm and pressing the **SELECT (ENTER) BUTTON** to choose that specific alarm. "ERASE?" will display. Press the **SELECT (ENTER) BUTTON** again. "ALARM ERASED" will appear. Press the **MENU UP (EXIT) BUTTON** to complete the action and return to the previous menu.
- For specific **ALARM(S)** information, refer to **Table 7**.

TABLE 7
Alarm Examples

Alarm(s)	Notes
MA T SENS ERR	Malfunctioning mixed air sensor
OA T SENS ERR	Malfunctioning outdoor air sensor
ACT STALLED	Actuator cannot reach desired percentage of opening
SYS ALARM	If AUX is set to SYS in SETPOINTS menu, SYS will display upon any registered alarm
NOTE: This is not a complete list of alarms. Additional alarms will display depending upon the parameter settings and configuration and attached equipment.	

NOTE: When using the Bard 8403-067 CO₂ controller, configure the sensor to 2-10VDC output (see CO₂ sensor instructions).

The JADE controller default setting is 1100 PPM. The economizer will modulate to maintain this CO₂ level in the room. The default setting can be changed in the SETPOINT menu in the DCV SET option. Default settings and DCV MIN and DCV MAX will appear only when the CO₂ sensor is connected.

In the SETPOINT menu, change the MAX VENT setting to 9.5 volts.

The CO₂ controller is active at any time the A terminal is energized.

The status of the CO₂ input can be viewed at any time in the STATUS menu.

Enthalpy Settings

If economizer is enthalpy-based and was shipped with the temp/humidity sensor, the economizer must be programmed for the specific enthalpy curve boundary desired for “free” outdoor cooling. The available enthalpy boundaries are all subject to specific OA temperature, OA humidity and OA dew points. If all of the OA conditions are below the specific points outlined in each boundary, the conditions are good to economize and economizer mode is set to “YES”. If some or all the OA conditions are above the specific points outlined in each boundary, the conditions are not good to economize and the economizer mode is set to “NO”.

ES3 is factory default.

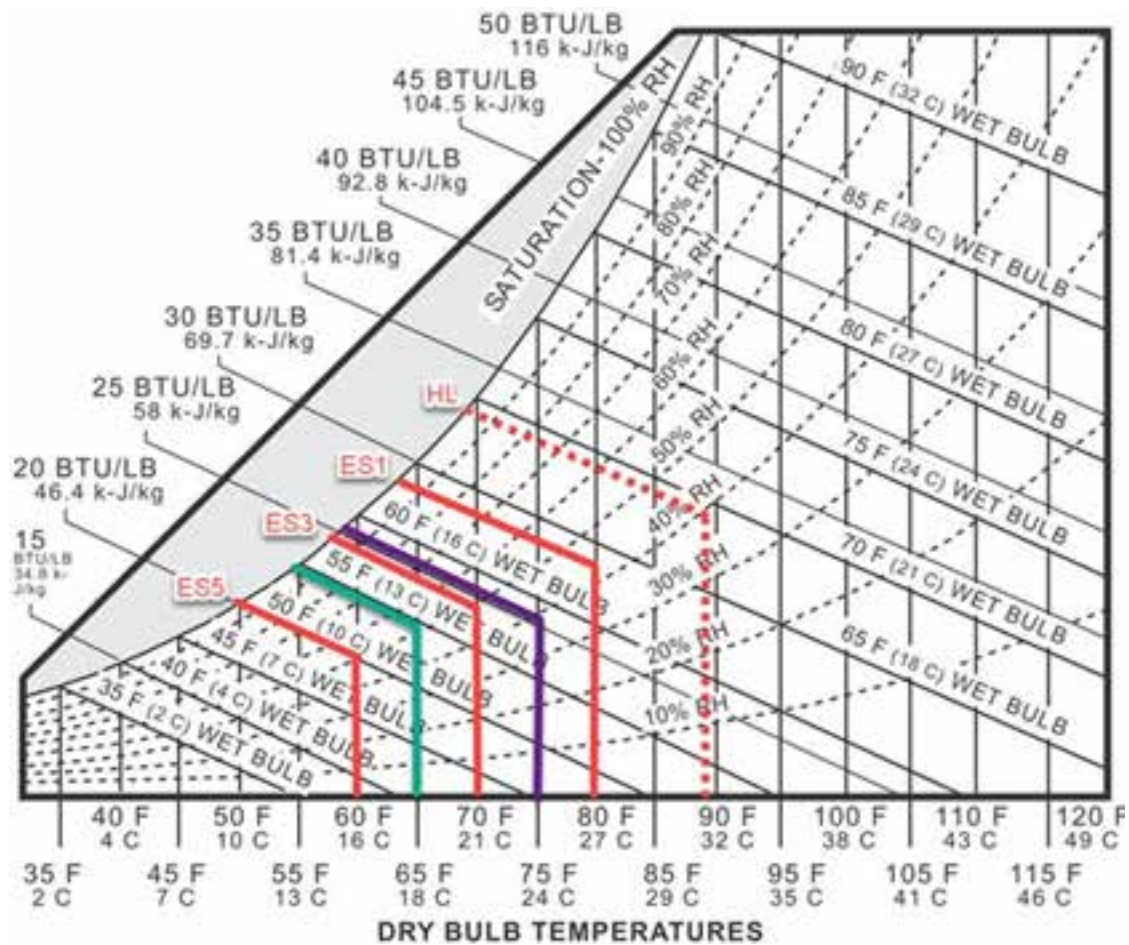
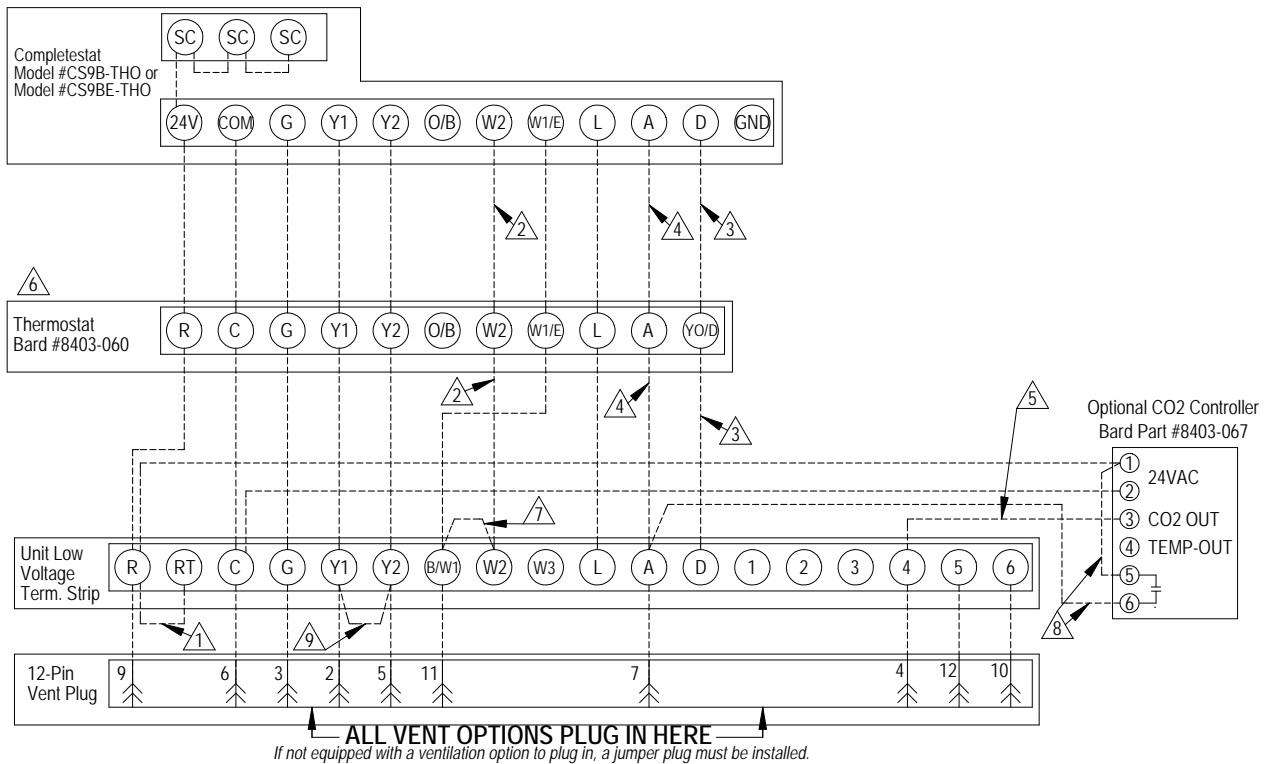

FIGURE 27
Required Control Connections for ECON-5 with Air Conditioners**



- △1 Factory installed jumper. Remove jumper and connect to N.C fire alarm circuit if emergency shutdown required.
- △2 Wire not needed below 15KW.
- △3 Wire required for dehumidification models only.
- △4 Do not connect "A" from thermostat if optional CO2 controller is used
- △5 0-10 VDC modulating CO2 control signal for modulating ventilation control (optional for ECON only - see vent instruction manuals)
- △6 Change model configuration from heat pump to heat/cool. Must be configured to programmable and fan set to be programmed fan for the "A" output to function during scheduled occupied periods. Must be configured for multi-stage for Y1 output to be active 1st stage cooling. For dehumidification, must be configured for "No Economizer" for YO/D to be active for humidity control.
- △7 Install jumper for 1 stage electric heat on units with less than 15KW
- △8 Do not add these wires if setting up for modulating control. See note 7.
- △9 Factory installed jumper. Remove jumper to activate Balanced Climate™ mode. A 2-stage thermostat is recommended for Balanced Climate mode.

MIS-3974 A

FIGURE 28
Required Control Connections for ECON-5 with Heat Pumps**

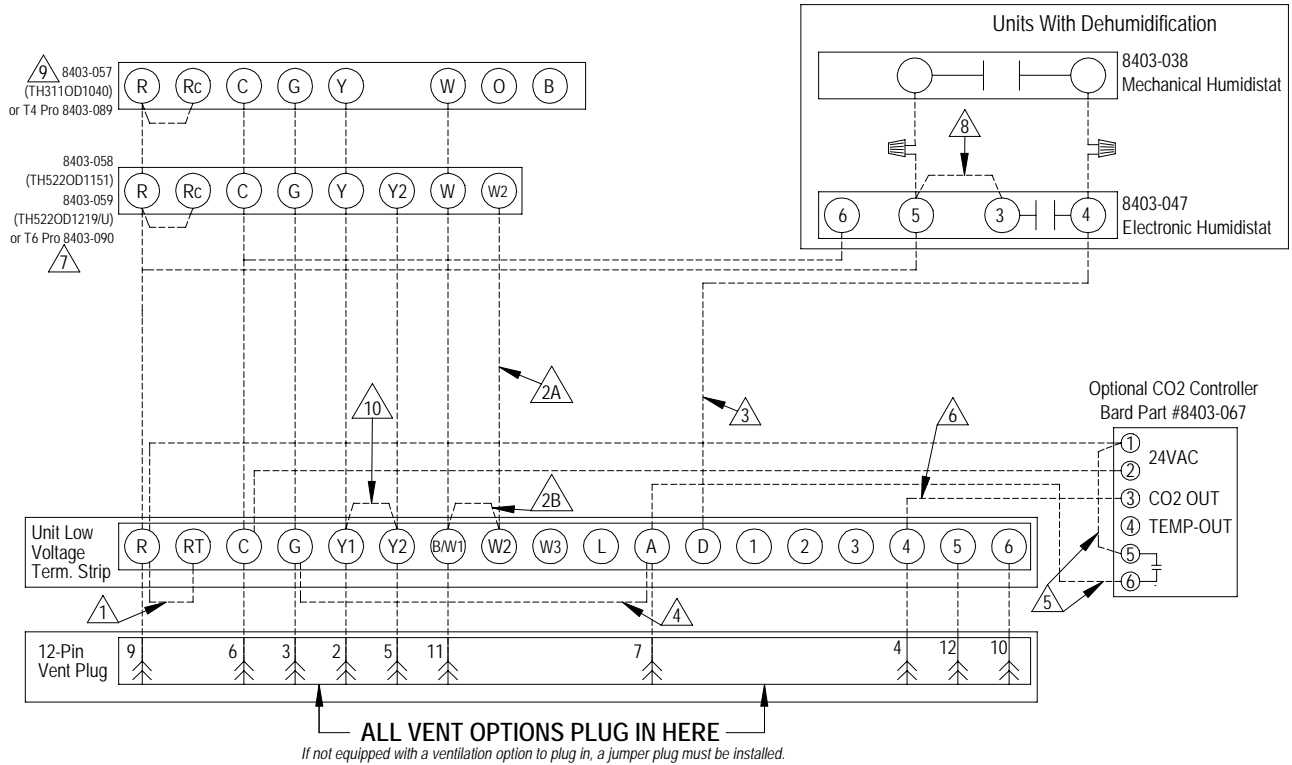

- ⚠ 1 Factory installed jumper. Remove jumper and connect to N.C fire alarm circuit if emergency shutdown required.
- ⚠ 2A Wire not needed below 15KW.
- ⚠ 2B Install Jumper for 1 stage electric heat on units with more than 10KW.
- ⚠ 3 Wire required for dehumidification models only.
- ⚠ 4 For vent operation, add jumper if optional CO2 controller is not used. Vent will run while blower is energized.
- ⚠ 5 Do not add these wires if setting up for modulating control. See note 7.
- ⚠ 6 0-10 VDC Modulating CO2 control signal for modulating ventilation control (Optional for ECON Only) - See vent installation manual.
- ⚠ 7 For 8403-058, change "system type", set up Function 1, From 5 (2 Heat/ 1 Cool heat Pump) to 6 (2 Heat / 2 Cool Conventional). For 8403-059, No change required.
- ⚠ 8 Jumper needs added.
- ⚠ 9 Thermostat will not work with units equipped with economizers.
- ⚠ 10 Factory installed jumper. Remove jumper to activate Balanced Climate™ Mode. A 2-stage thermostat is recommended for Balanced Climate mode.

MIS-3975 A

ECONOMIZER SEQUENCE OF OPERATION

Condition – Cool/Dry OA Conditions

- 1st Stage Cooling closes and sends signal to **JADE™** control. Since the air temperature outside is cooler than the preset **DRYBULB SET** setting, or is below the **ENTH CURVE** boundary in the **SETPOINTS** menu, the actuator will power the economizer damper to “economizer” mode as the indoor blower motor starts. The mixed air sensor senses a mixture of return air and cool outdoor air and modulates opening to achieve preset **MAT SET** setting in **SETPOINTS** menu. Compressor operation is inhibited (see Figure 29).
- 2nd Stage Cooling closes and sends a signal to **JADE™** control, which closes the Y1-O relay to begin mechanical cooling. **The economizer damper REMAINS OPEN in tandem operation with the compressor** as long as the OA conditions do not drop below the preset **DRYBULB SET/ENTH CURVE** settings in the **SETPOINTS** menu (see Figure 30).
- 3rd Stage Cooling (if available) closes and sends a signal to **JADE™** control, which closes the Y2-O relay to begin 2nd stage mechanical cooling. **The economizer damper REMAINS OPEN in tandem operation with the compressor** as long as the

temperature outside does not drop below the preset **DRYBULB SET** setting in the **SETPOINTS** menu (see Figure 30).

Condition – Warm/Humid OA Conditions

- 1st Stage Cooling closes and sends signal to **JADE™** control. Since the OA conditions are above the preset **DRYBULB SET/ENTH CURVE** setting in the **SETPOINTS** menu, the control will simply close the Y1-O relay to initiate mechanical cooling. **The economizer damper will remain closed or in a minimum ventilation setting depending upon occupied status** (see Figure 31).
- 2nd Stage Cooling (if available) closes and sends a signal to **JADE™** control. Since the OA conditions are still above than the preset **DRYBULB SET/ENTH CURVE** setting in the **SETPOINTS** menu, the control will simply close the Y2-O relay to initiate 2nd stage mechanical cooling. **The economizer damper will remain closed or in a minimum ventilation setting depending upon occupied status** (see Figure 31).

FIGURE 29
100% Airflow

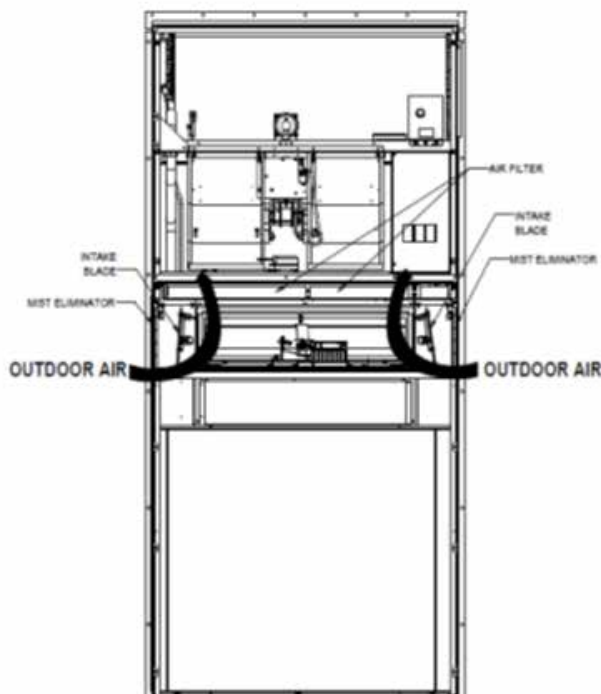

FIGURE 30
Mixed Airflow Path

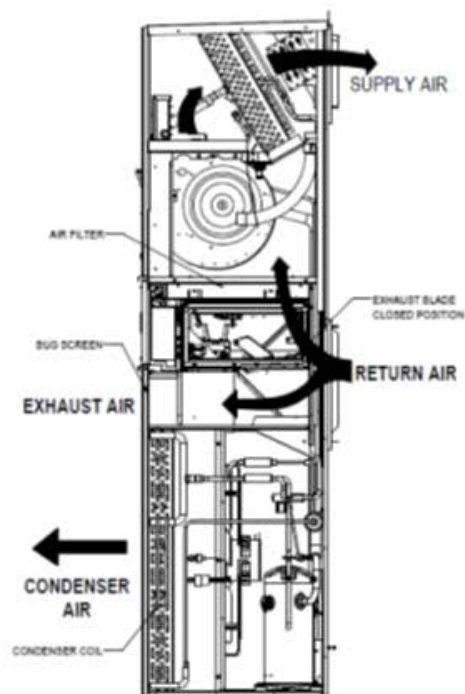
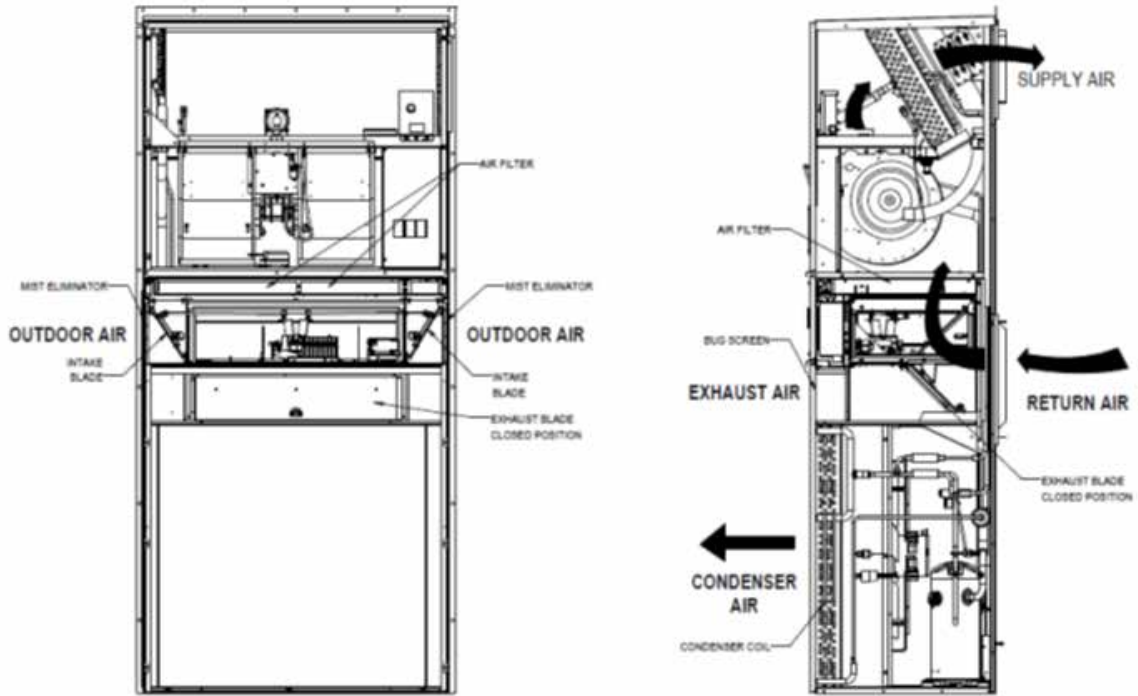
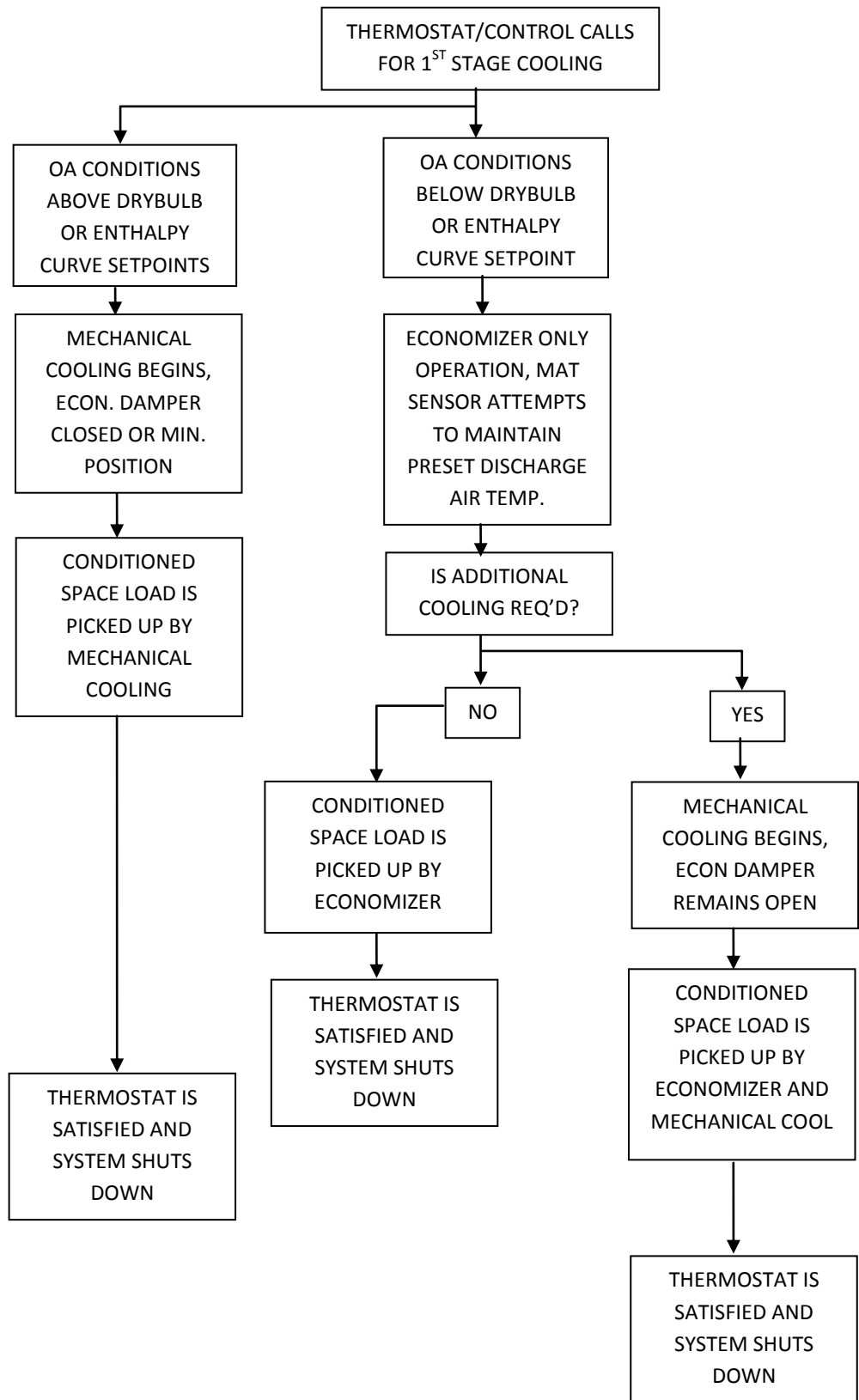

FIGURE 31
Call for Compressor or Fan Only with Ventilation Off



MC-4037

Economizer Operation for Single Stage:



**Balanced Climate Mode – S, Y and Z Option
Economizer Sequence of Operation**

**Call for cooling and ECONOMIZER IS NOT AVAILABLE
(due to outdoor conditions):**

Y1 energizes mechanical cooling and the Balance Climate fan speed simultaneously. If the outdoor conditions are not acceptable, the Y2 terminal will energize full load compressor and increase the fan speed to the rated airflow. When the temperature drops below the Y2 setpoint, the unit will return to part load and Balanced Climate fan speed. When the cooling call is satisfied, the compressor will shut down and the economizer will move to minimum position (ventilation setting) and the fan will continue to run at RATED airflow if A is energized on the low voltage terminal strip.

Call for cooling and ECONOMIZER IS AVAILABLE (due to outdoor conditions):

Two stage cooling thermostat is required and connector is disconnected at JADE™ controller to enable Balanced Climate mode (see Figure 7 on page 5).

Unit has a call for ventilation: Damper to Min position and fan will run at RATED airflow. Y1 energizes economizer and the Balance Climate fan speed simultaneously. If the temperature continues to rise, the Y2 terminal will energize part load compressor and increase the fan speed to the RATED airflow. When the temperature drops below the Y2 setpoint, the unit will return to part load and Balanced Climate fan speed. When the cooling call is satisfied, the compressor will shut down and the economizer will move to minimum position (ventilation setting) and the fan will increase to run at RATED airflow if A is energized on the low voltage terminal strip.

**TABLE 8
Unit Operation with S (Part Flow), Y and Z (Full Flow) Economizer Options**

Unit Operation	Occ. Signal	Low Voltage 24VAC							Speed Taps			Fan Speed	Comp. Oper.	Damper
		G	Y1	Y2	W1	W2	A	D	1	2	3-4-5 ¹			
Fan Only	Yes	X					X		X			Vent	Off	Min Pos
Fan Only	No	X							X			Vent	Off	Closed
BC Cooling	Yes		X				X		X	X		B Climate	Econ	Min Pos
BC Cooling	No		X						X	X		B Climate	Econ	Closed
Full Load Cool	Yes		X	X			X		X	X	X	Lo/Med/Hi	On	Min Pos
Full Load Cool	No		X	X					X	X	X	Lo/Med/Hi	On	Closed
1st Stage Heat	Yes				X		X				X	Lo/Med/Hi	Off	Min Pos
1st Stage Heat	No				X						X	Lo/Med/Hi	Off	Closed
2nd Stage Heat	Yes				X	X	X				X	Lo/Med/Hi	Off	Min Pos
2nd Stage Heat	No				X	X					X	Lo/Med/Hi	Off	Closed
Dehumidify ²	Yes						X	X	X	X		B Climate	On	Min Pos
Dehumidify ²	No							X	X	X		B Climate	On	Closed

BC and B Climate – Balanced Climate

¹ Fan speed is selectable through the blower speed control terminal block. LO (default), MED or HI speeds can be used.

² Dehumidification operation is disabled when a call for heating or cooling occurs. Unit runs at Balanced Climate speed during dehumidification operation.

Economizer Operation – Balanced Climate Mode

Connector disconnected from **JADE™** controller (see Figure 7 on page 5)

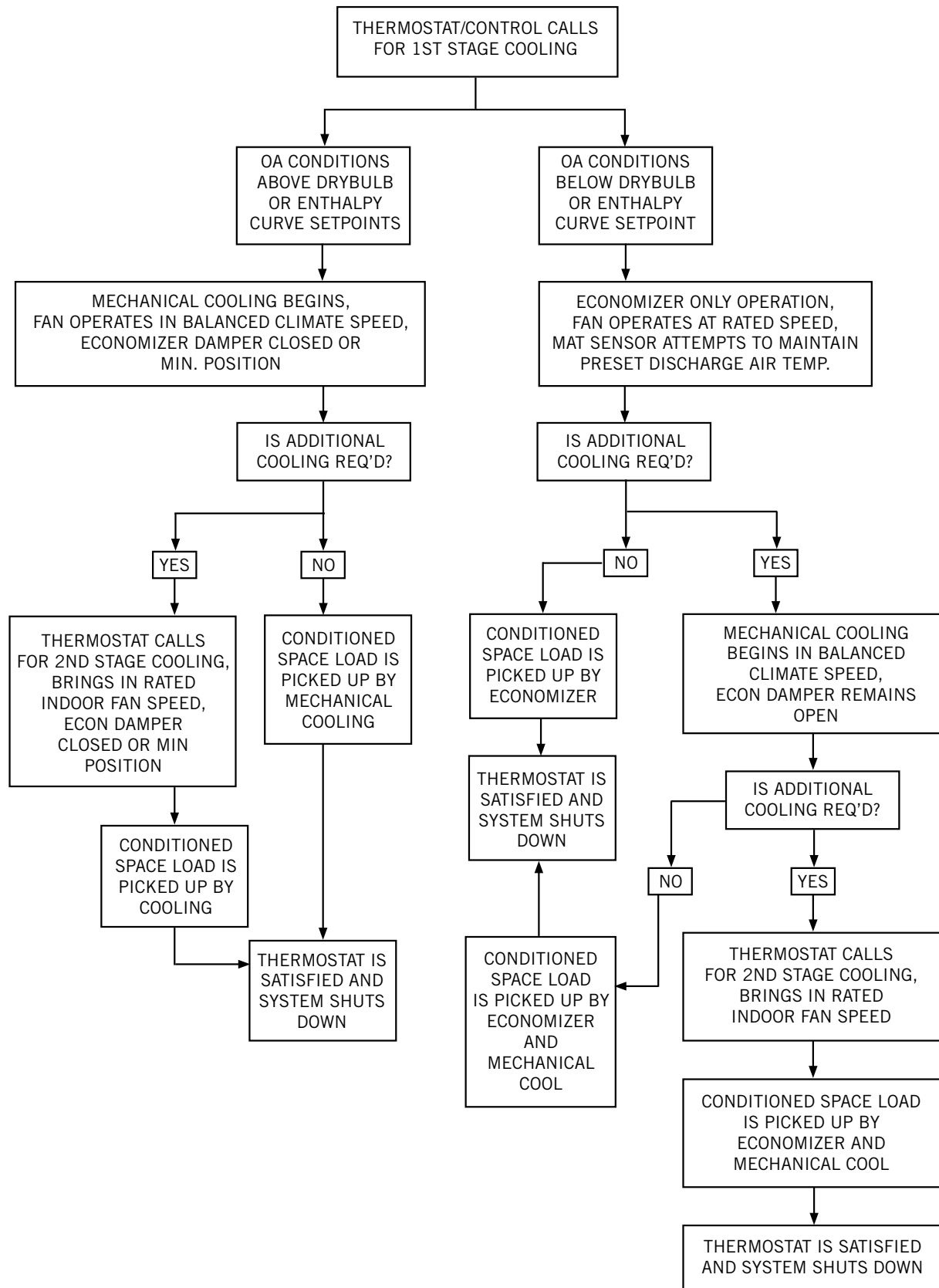
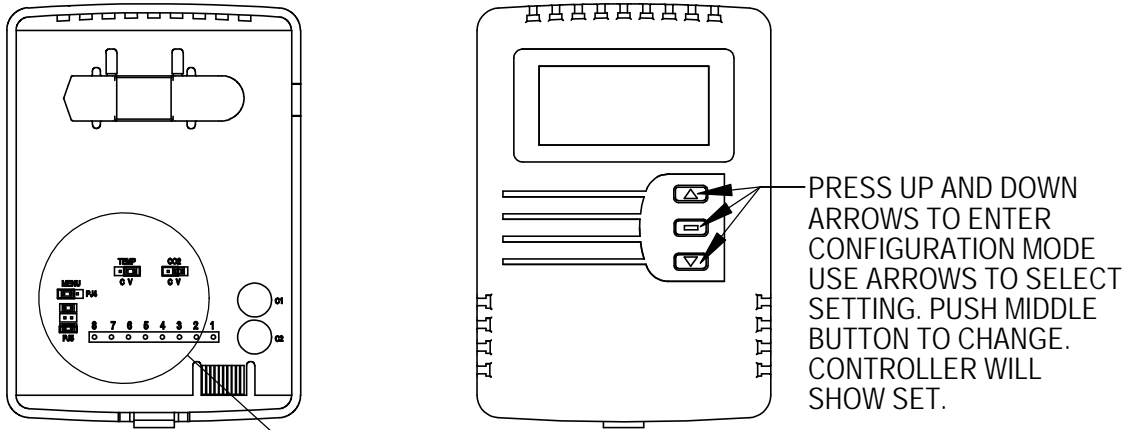
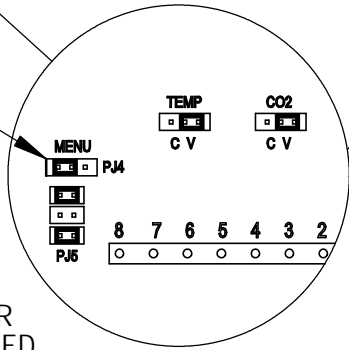

FIGURE 32
CO₂ Sensor Default and Final Settings
Bard Part #8403-067 CO₂ Controller



NOTE: MENU JUMPER MUST BE SET TO "ON" TO CHANGE ANY SETTINGS WITH THE FRONT BUTTONS. TO LOCK THE CO₂ CONTROLLER MOVE JUMPER TO "OFF" AFTER IT HAS BEEN CONFIGURED



Settings	Recommended	Default
RON	Not Used	
ROF	Not Used	
DSP	C	CT
UNI	US	US
COL	700	0
COH	1500	2000
TOL	Not Used	
TOH	Not Used	
BAR	See Instruction with Controller For High Altitude Installations	
CAL	Used for Field Calibration	

MIS-4025

GRAPH 1
W42AC ECON-E & WD Ventilation Delivery

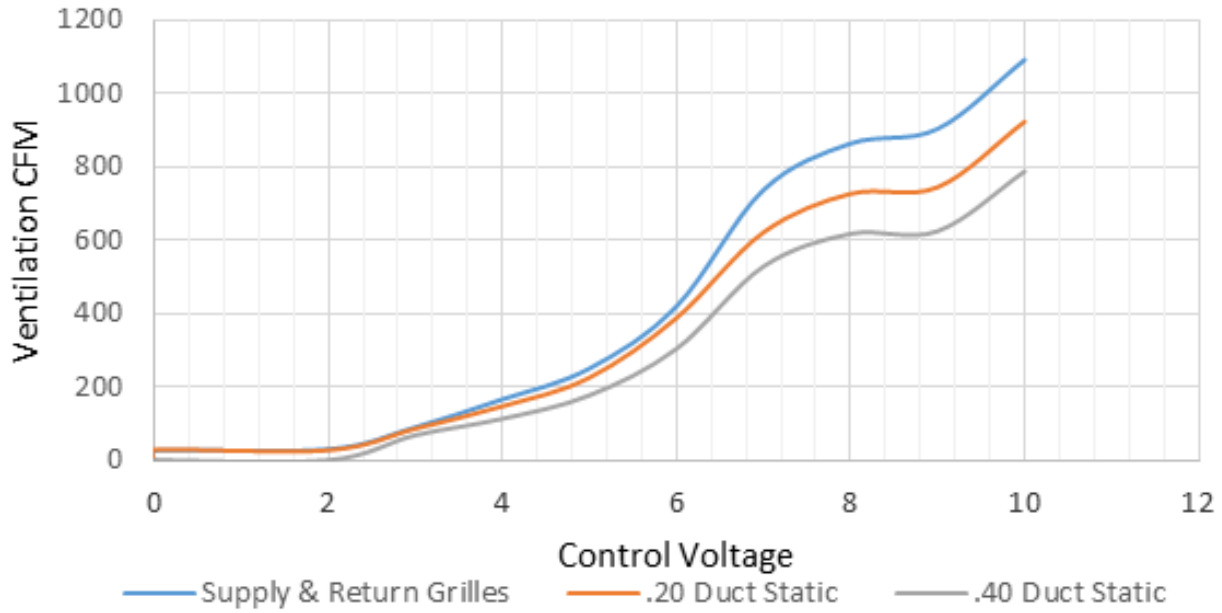

GRAPH 2
W48AC ECON-E & WD Ventilation Delivery

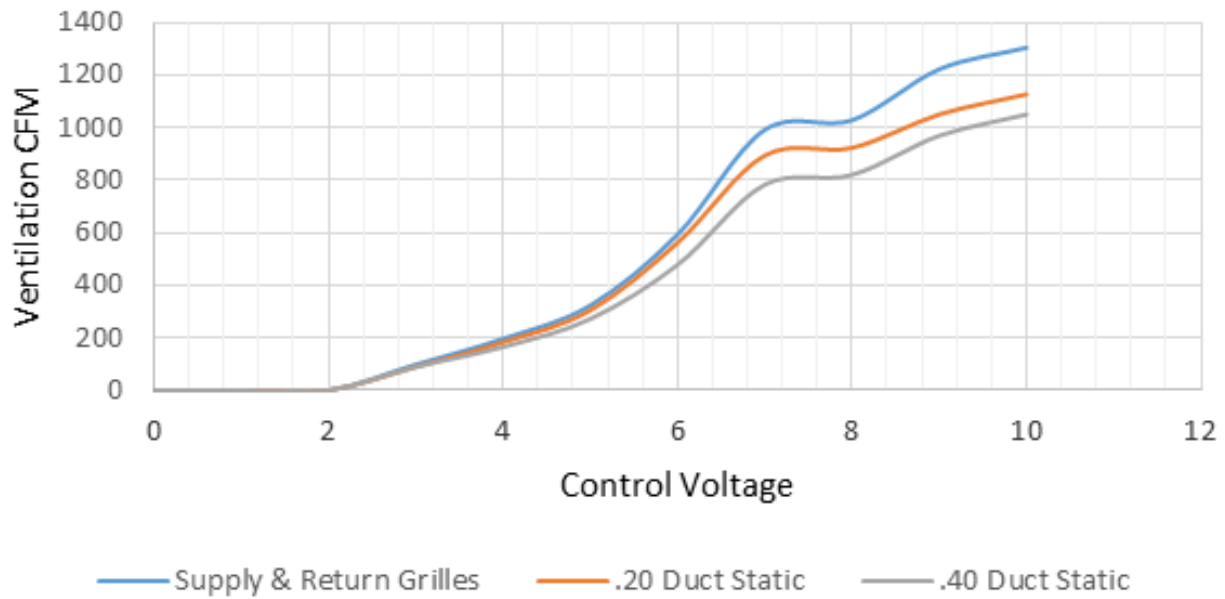

GRAPH 3
W60AC ECON-E & WD Ventilation Delivery

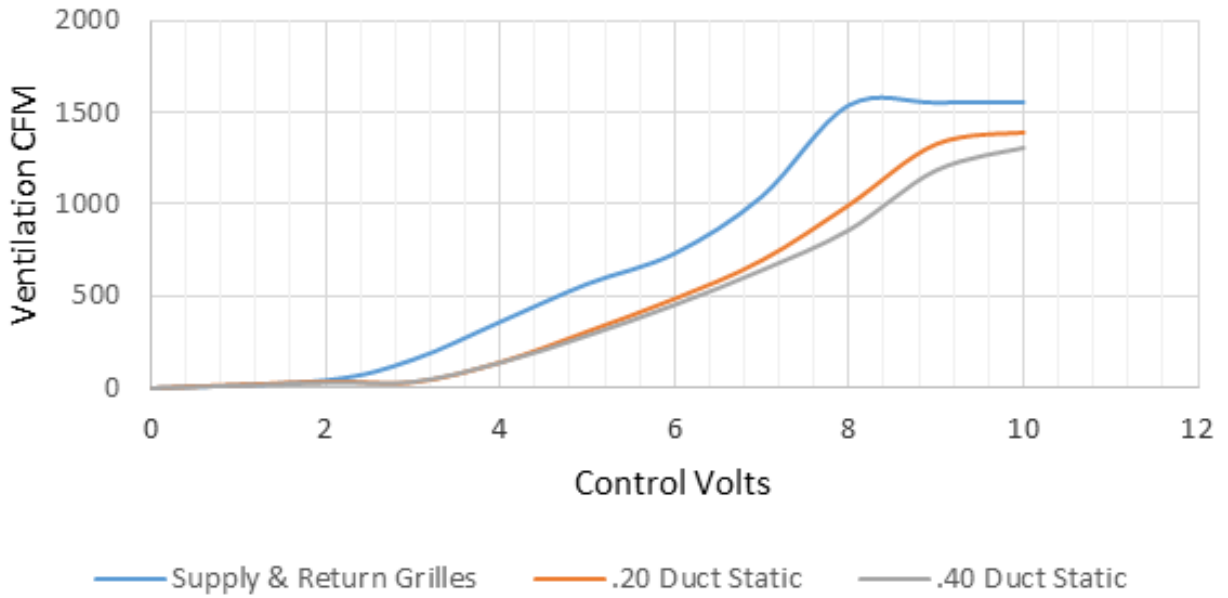

GRAPH 4
W72AC ECON-E & WD Ventilation Delivery

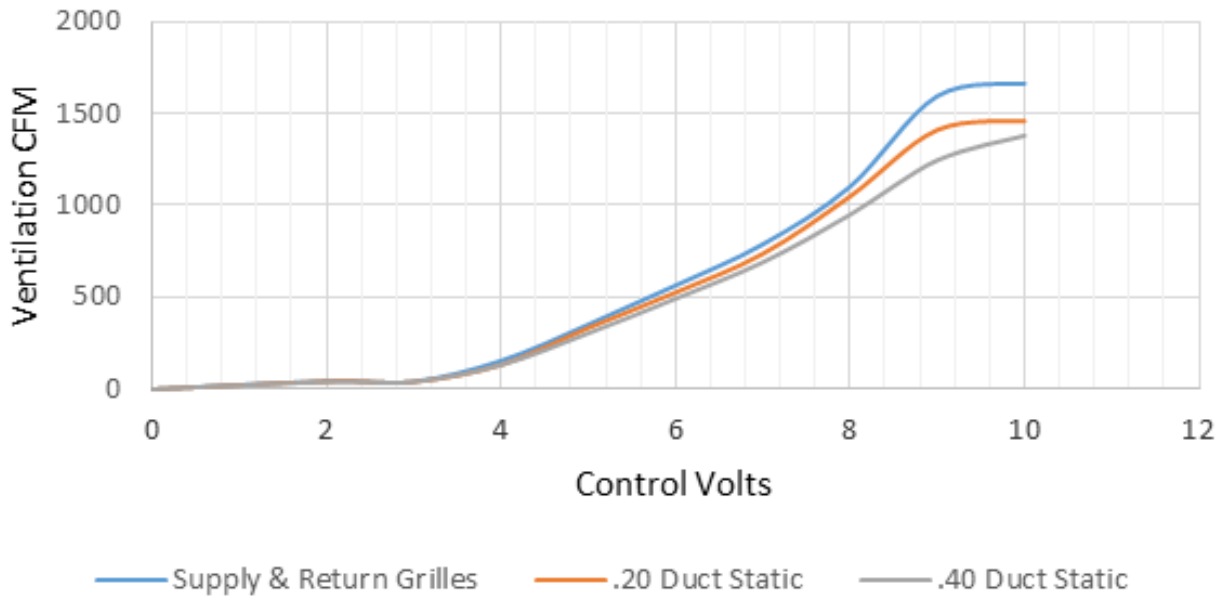
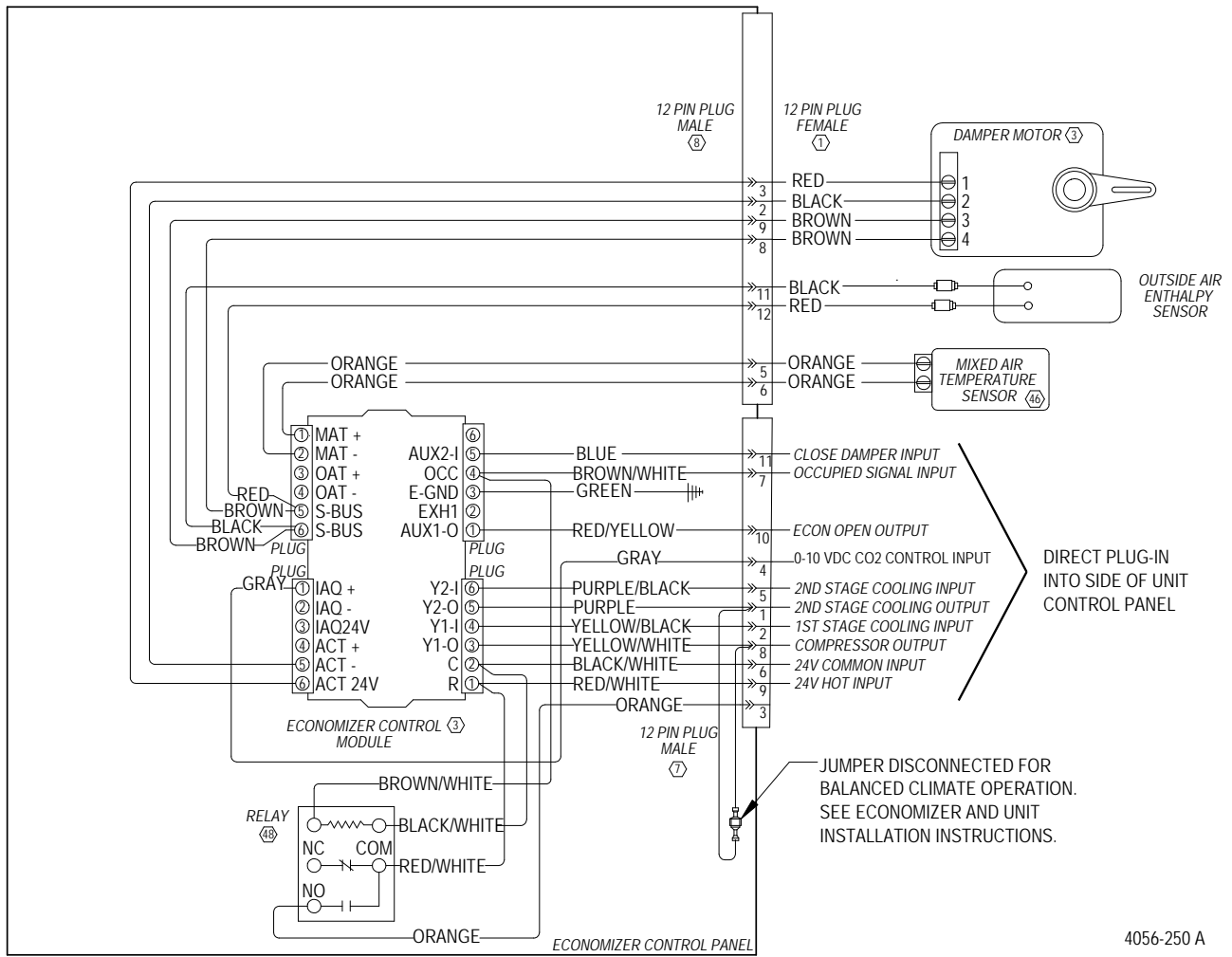
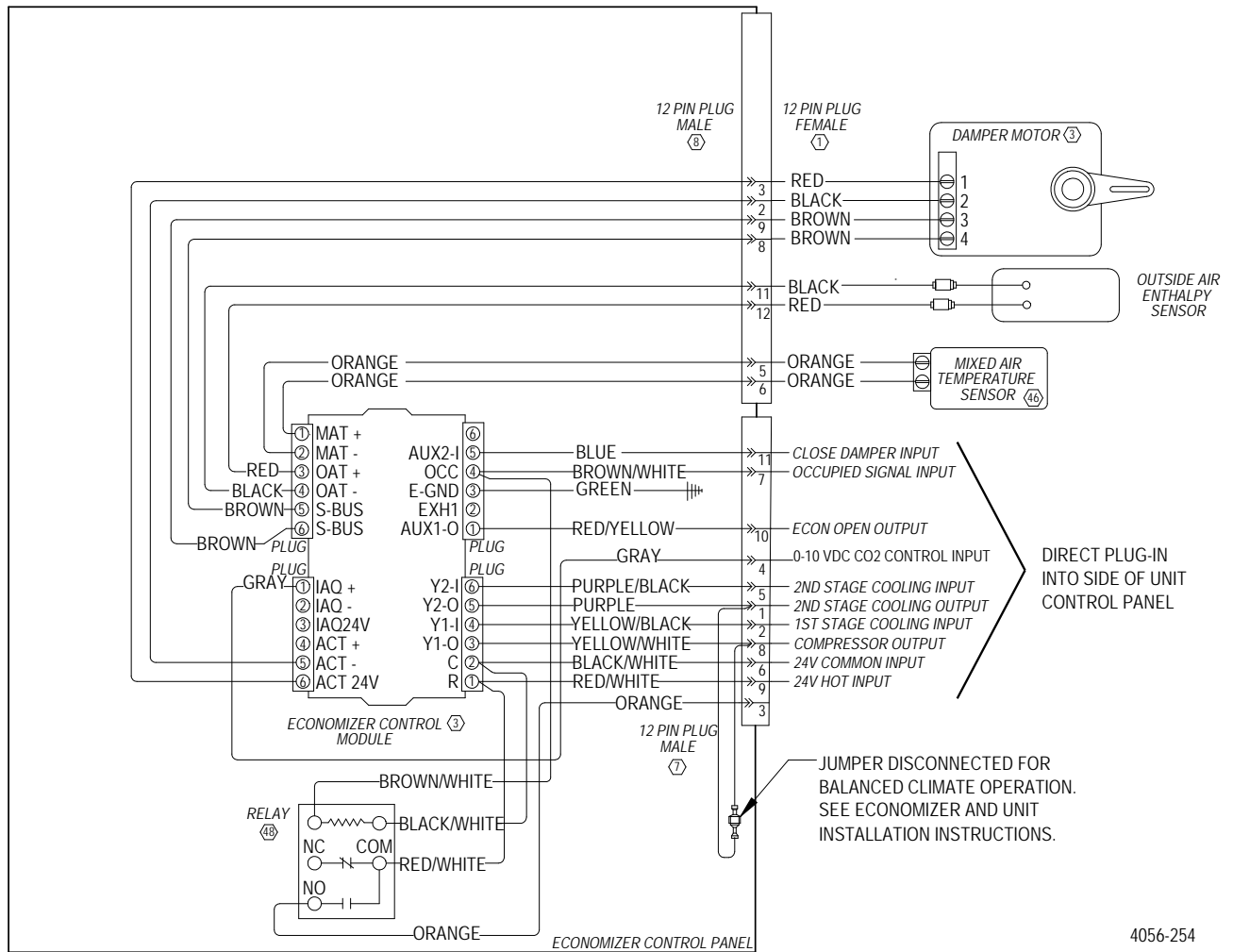

FIGURE 33
Wiring Diagram – Enthalpy Sensor



4056-250 A

FIGURE 34
Wiring Diagram – Temperature Only Sensor



4056-254