INSTALLATION INSTRUCTIONS

Partial Flow Economizer with Exhaust for Building Applications

Models:

ECON-S2 & ECON-S3

Factory-Installed Vent Option with Enthalpy Outdoor Control

For Use with 1-1/2 Through 3 Ton
Wall Mount Air Conditioners
and Heat Pumps

NOTE: *These instructions are written to cover field-installed economizers, but are also included with factory-installed economizers. For factory-installed economizers, all portions addressing “installation” are for reference only.*



Climate Control Solutions

Bard Manufacturing Company, Inc.
Bryan, Ohio 43506
www.bardhvac.com

Manual : 2100-700D
Supersedes: 2100-700C
Date: 6-8-21

CONTENTS

| | |
|--|-----------|
| GENERAL..... | 3 |
| Nomenclature | 3 |
| General Information | 3 |
| Field-Supplied Tools Needed | 3 |
| Unpacking | 3 |
| Description | 3 |
| INSTALLATION OF FIELD-INSTALLED ECONOMIZER..... | 4 |
| Installation | 4 |
| Preparing Unit for Economizer Installation | 4 |
| Outdoor Air Sensor Installation | 7 |
| Economizer Installation | 7 |
| Economizer Checkout..... | 9 |
| Control Wiring Connection Diagrams..... | 10 |
| START-UP/CHECKOUT PROCEDURES | 14 |
| JADE™ Economizer Controller | 14 |
| Review/Customize System Setup | 14 |
| Enthalpy Settings | 18 |
| Economizer Sequence of Operation | 19 |
| Condition – Cool/Dry OA Conditions..... | 19 |
| Condition – Warm/Humid OA Conditions | 19 |
| Economizer Operation for Single Stage | 21 |
| Balanced Climate Mode – S, Y and Z Option | |
| Economizer Sequence of Operation | 22 |
| Economizer Operation – Balanced Climate Mode .. | 23 |

WARNING

Exposed moving parts.

Disconnect electrical power before servicing.

Failure to do so could result in severe injury or amputation.

| | |
|--|-----------|
| FIGURES | |
| Figure 1 Wall-Mount Unit Access Panels | 4 |
| Figure 2 Condenser Exhaust Plate with Screen..... | 5 |
| Figure 3 Filter and Filter Brackets | 5 |
| Figure 4 Filter Bracket and Filter Bracket Fill Plate Installation | 6 |
| Figure 5 Outdoor Air Sensor Installation | 7 |
| Figure 6 Control Panel..... | 7 |
| Figure 7 Mixed Air Temp Sensor Installation | 8 |
| Figure 8 Vent Option Door Installation..... | 9 |
| Figure 9 Programmable Thermostat Connections for Air Conditioner with Economizer | 10 |
| Figure 10 Programmable Thermostat Connections for Heat Pump with Economizer | 11 |
| Figure 11 Non-Programmable Thermostat Connections for Air Conditioner with Economizer | 12 |
| Figure 12 Non-Programmable Thermostat Connections for Heat Pump with Economizer | 13 |
| Figure 13 JADE™ Economizer Controller | 14 |
| Figure 14 100% Outside Airflow Path | 19 |
| Figure 15 Mixed Airflow Path | 19 |
| Figure 16 100% Closed Loop Airflow Path | 20 |
| Figure 17 CO ₂ Sensor Default and Final Settings Bard Part #8403-096 CO ₂ Controller | 24 |
| Figure 18 Wiring Diagram – Enthalpy Sensor | 27 |

| | |
|--|----|
| TABLES | |
| Table 1 Economizer Application | 3 |
| Table 2 System Setup Menu Levels | 15 |
| Table 3 Advanced Setup Menu Levels..... | 15 |
| Table 4 Setpoints Menu Levels..... | 16 |
| Table 5 Checkout Menu Levels..... | 16 |
| Table 6 Status Menu Levels..... | 17 |
| Table 7 Alarm Examples | 17 |
| Table 8 Unit Operation with S (Part Flow), Y and Z (Full Flow) Economizer Options ... | 22 |

| | |
|---------------------------------------|----|
| GRAPHS | |
| Graph 1 W18 Ventilation Delivery..... | 25 |
| Graph 2 W24 Ventilation Delivery..... | 25 |
| Graph 3 W30 Ventilation Delivery..... | 26 |
| Graph 4 W36 Ventilation Delivery..... | 26 |

Economizer Features

- One piece construction—easy to install. Direct-drive actuator eliminates linkage.
- Exhaust air damper—built in with positive closed position. Provides exhaust air capability to prevent pressurization of tight buildings.
- **JADE™** controller provides nearly limitless customization on a solid, intuitive electronic platform.
- Actuator Motor – 24 volt, power-open, spring-return, direct-coupled with stall protection. Self-centering shaft clamp and access cover facilitate ease of replacement/maintenance.
- Proportioning-type control for maximum “free” cooling economy and comfort with up to 100% outside air.
- Enthalpy sensor to monitor outdoor air conditions.
- Minimum Ventilation Position available for required ventilation of occupants or dilution of pollutants.
- Mixed air sensor to monitor outdoor and return air to automatically modulate damper position.

Economizer with Exhaust Model Nomenclature

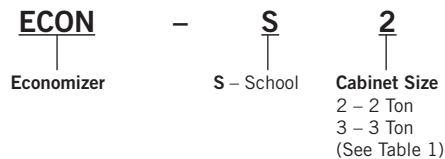

General Information

The economizer should only be installed by a trained heating and air conditioning technician. These instructions serve as a guide to the technician installing an economizer package, not as a step-by-step procedure with which the mechanically inclined owner can install the package.

The economizer housing is shipped in one carton, which contains the electrical harness, miscellaneous hardware and installation instructions.

The economizer installation requires the use of a 2-stage cooling thermostat (if there is not one already present) and requisite amounts of low voltage conductor wire for two-stage cooling. The number of low-voltage control conductors will vary depending upon application.

If using a master controller, the MC4002 controller is designed specifically to control two (2) redundant wall mount units equipped with economizers.

Any wall mount unit equipped with an economizer must also have a factory/field installed low ambient control. Please refer to appropriate model/year Specification Sheet for requisite field installed low ambient control kit part numbers.

Field-Supplied Tools Needed

- Appropriate personal protection equipment, including gloves and safety glasses
- 5/16" nut driver
- Phillips head screwdriver
- Small flat head screwdriver for securing wire in terminal blocks
- Electrical tools
- Multimeter

Unpacking

Upon receipt of the equipment, be sure to compare the model number found on the shipping label with the accessory identification information on the orders and shipping document to verify that the correct accessory has been shipped.

Inspect the carton housing of each economizer assembly as it is received and, before signing the freight bill, verify that all items have been received and there is no visible damage. Note any shortages or damage on all copies of the freight bill. The receiving party must contact the last carrier immediately, preferably in writing, requesting inspection by the carrier's agent. Concealed damage not discovered until after loading must be reported to the carrier within 15 days of its receipt.

Description

ECON-S* economizers are designed to be used with the wall mount series air conditioners and heat pumps, shown in Table 1, equipped with low ambient controls. They are electromechanical economizer systems designed to provide "free" cooling where the outdoor air temperature/enthalpy is cool enough to provide the needed cooling without running the compressor, or in addition to the compressor. When cooling is required, the system automatically takes advantage of cold outdoor air when available and uses it for first stage cooling. This then reduces the need to run the air conditioning compressor providing lower operating costs and increasing the service life of the equipment. If the outdoor air temperature/enthalpy is too warm to be sufficient for cooling, the dry bulb outdoor air temperature sensor detects the condition and automatically closes the outdoor air intake/exhaust damper, opens the return air damper and switches to compressor-only operation.

Without attention from the end user, the economizer assembly is meant to automatically achieve maximum savings while ensuring appropriately cool space temperatures. The economizer utilizes a fully modulating damper actuator, which will control intake/exhaust in order to obtain and maintain a factory-set minimum supply air temperature. As a secondary feature, the economizer assembly can be programmed for a minimum ventilation based on an "occupied" (or otherwise dedicated) 24V signal to satisfy fresh air ventilation on populated structures or dilution of internal pollutants.

ECON-S* Series economizers are not for use with variable capacity ECU models.

**TABLE 1
Economizer Application**

| MODEL ① | FOR USE WITH FOLLOWING UNITS | | |
|---------|------------------------------|------|------|
| ECON-S2 | W18A | W18H | W18L |
| | W24A | W24H | W24L |
| ECON-S3 | W30A | W30H | W30L |
| | W36A | W36H | W36L |

① Low ambient control is required w/economizer for low temperature operation.

INSTALLATION OF FIELD-INSTALLED ECONOMIZER

Installation

WARNING

Electrical shock hazard.

Have a properly trained individual perform these tasks.

Failure to do so could result in electric shock or death.

CAUTION

Cut hazard.

Wear gloves to avoid contact with sharp edges.

Failure to do so could result in personal injury.

Preparing Unit for Economizer Installation

1. Disconnect power to unit.
2. Unpack the economizer assembly, which includes the integral economizer with attached electrical harness, mixed air sensor, body panels, miscellaneous hardware and installation instructions.
3. From existing wall mount unit, remove and save (or discard) as directed (see Figure 1):
 - Blower access panel and screws (save)
 - Ventilation access panel (discard)
 - Filter access panel (save)
 - Filter (save)
 - Outer and inner control panel doors and screws (save)
4. Remove and discard the exhaust cover plate (save screws).

FIGURE 1
Wall-Mount Unit Access Panels

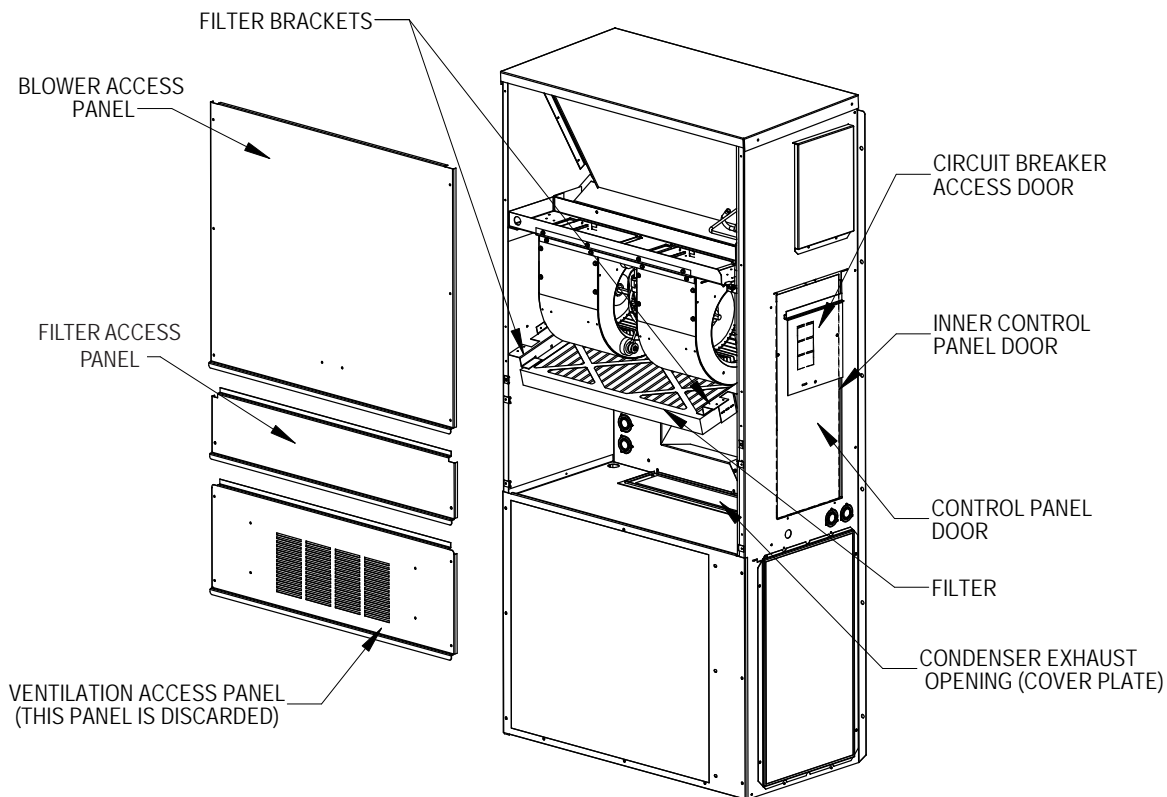

MIS-3619 A

5. Install new condenser exhaust plate with screen over opening into condensor section (see Figure 2).
6. Remove filter brackets (see Figure 3). The circuit breaker offset plate must be loosened and moved slightly to gain access to several of the screws holding the filter brackets in place. Tighten screws holding control panel after filter brackets have been removed.
7. Install filter bracket fill plate as shown in Figure 4 on page 6.
8. Install provided filter brackets on economizer (see Figure 4).

FIGURE 2
Condenser Exhaust Plate with Screen

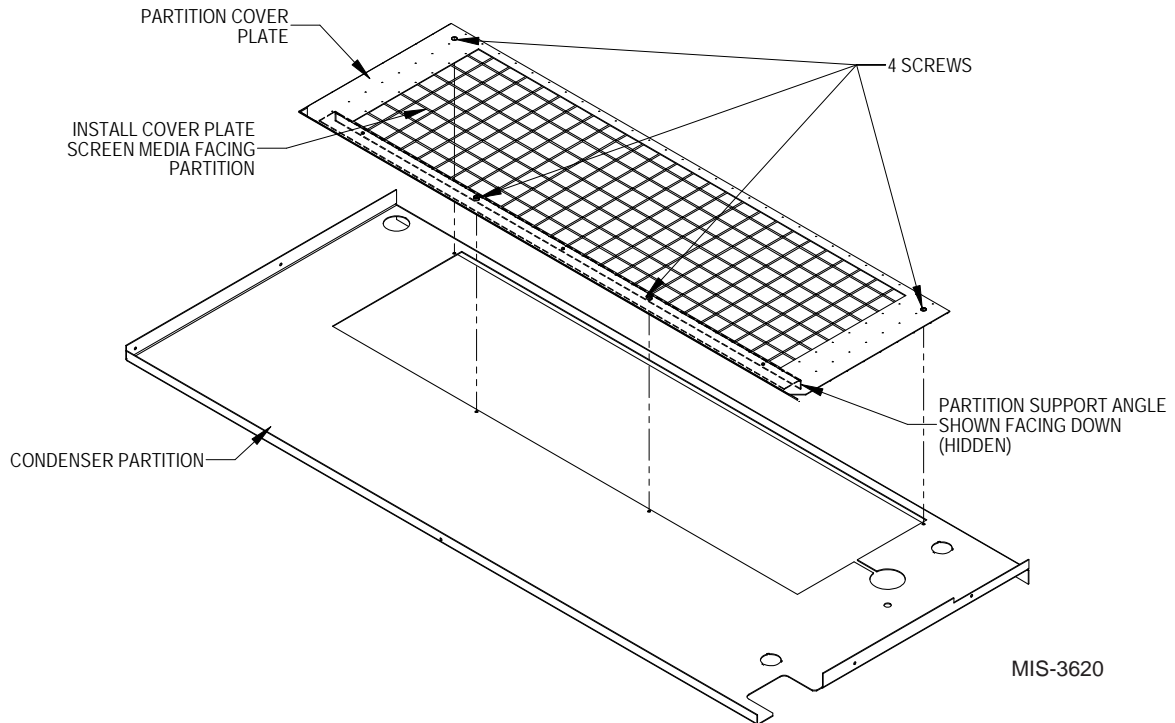

FIGURE 3
Filter and Filter Brackets

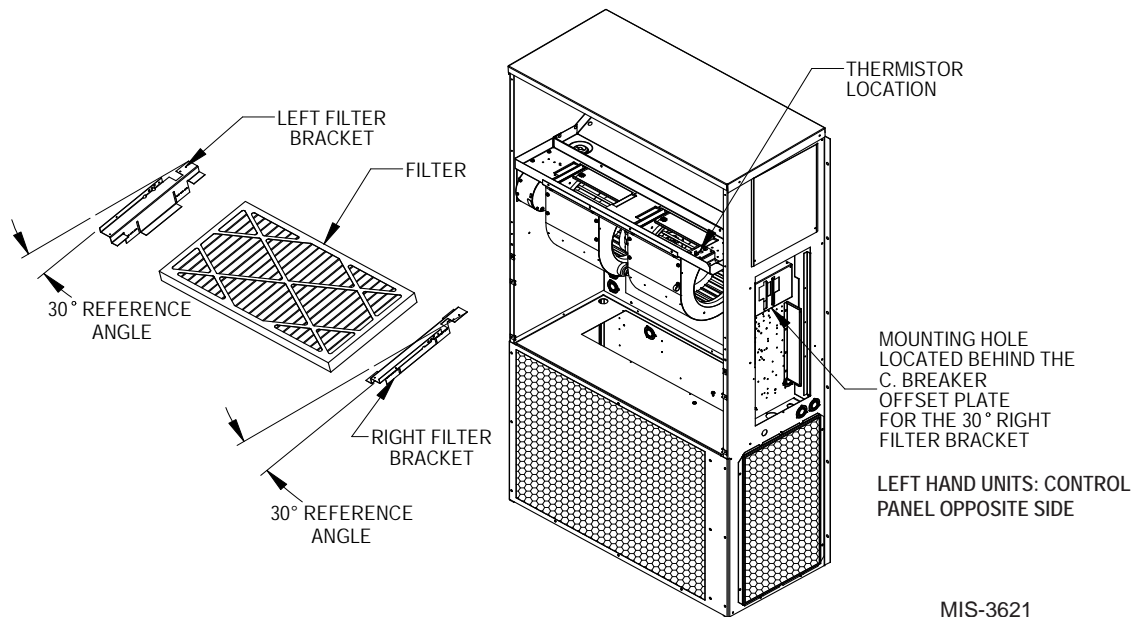
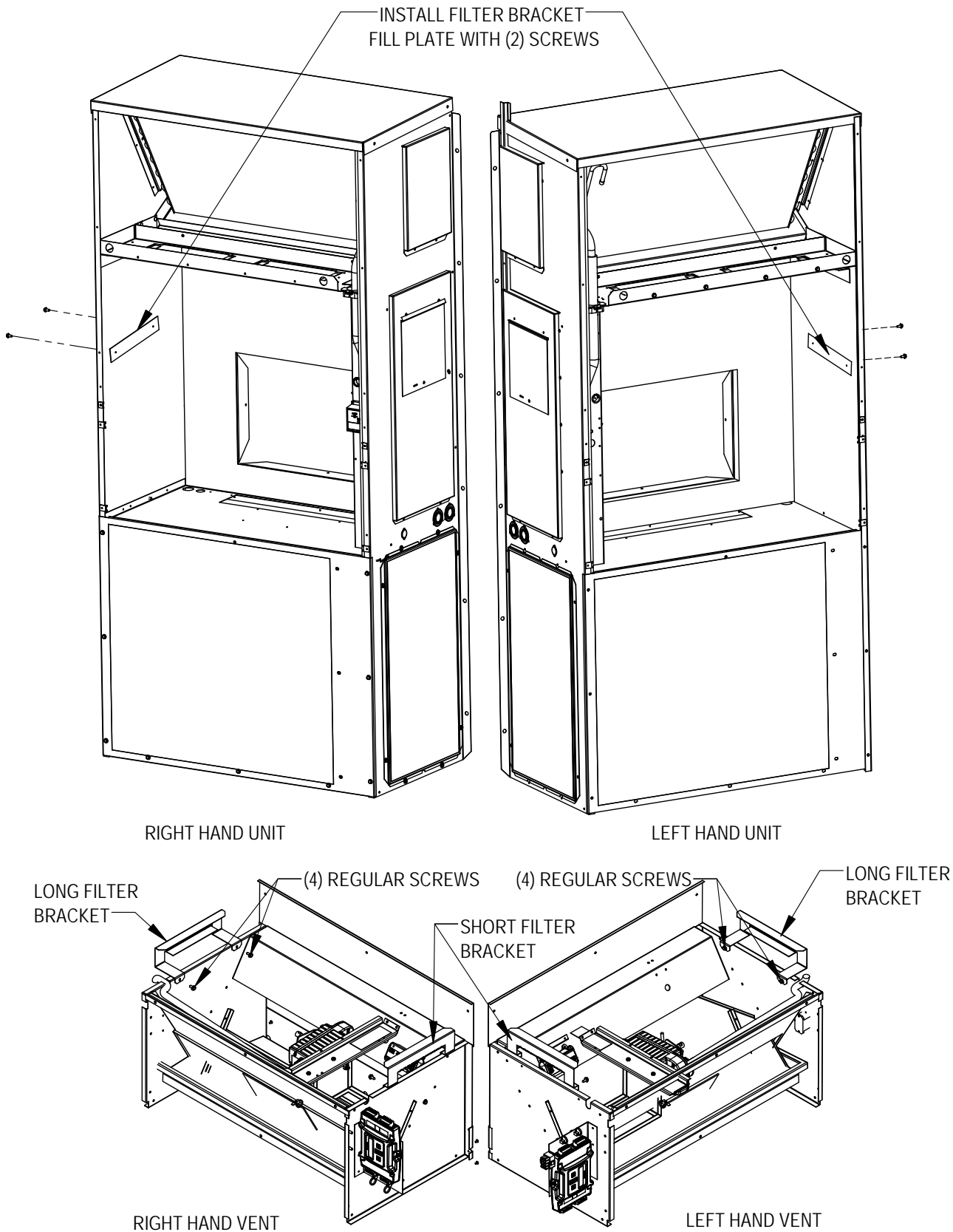

FIGURE 4
Filter Bracket and Filter Bracket Fill Plate Installation



MIS-4018

Outdoor Air Sensor Installation

1. Remove and save both side grilles and screws.
2. Install the outdoor enthalpy sensor in the lower condenser section on the side opposite the control panel with two (2) screws provided as shown in Figure 5.

FIGURE 5
Outdoor Air Sensor Installation



3. Route the wire harness across the back of the unit and secure with two wire ties (provided). Push harness up through the grommet in the bottom of the control panel (see Figure 6). Secure with wire ties (provided) to the other wires in the grommet. Ensure the wire harness cannot contact moving parts or copper tubing. Replace side grilles.

Economizer Installation

1. Remove (and discard) left and right filter brackets from economizer assembly if existing wall mount unit brackets are in place.
2. Insert economizer into opening in wall unit, being careful not to tear unit insulation. To clear blowers, position economizer at 45° angle under the blowers. Fully seat economizer assembly to the rear of the wall unit cavity. Slide economizer towards control panel and line up with return air opening in back of wall unit.
3. Insert 12-pin plug into front of control panel. See Figure 6 below and Figure 7 on page 8.
4. Route the two orange wires along refrigerant lines behind the filter bracket (if applicable) to terminate at the blower partition (see Figure 7).
5. Install the mixed air temperature sensor and bracket in blower partition (see Figure 7 Top View) using the two existing holes. (Holes are in opposite side on left hand units). If necessary, remove the shield to aid in mounting the sensor (replace after mounting sensor). Insert white, two-pin sensor plug into sensor housing. Coil excess orange wires and wire tie to suction/discharge line.
6. Run black and red wire from economizer upper 12-pin wiring harness through grommet and other bushing into the control panel and connect to the black and red wire sensor wires (see Figure 6). Wrap and wire tie the excess wire.

FIGURE 6
Control Panel

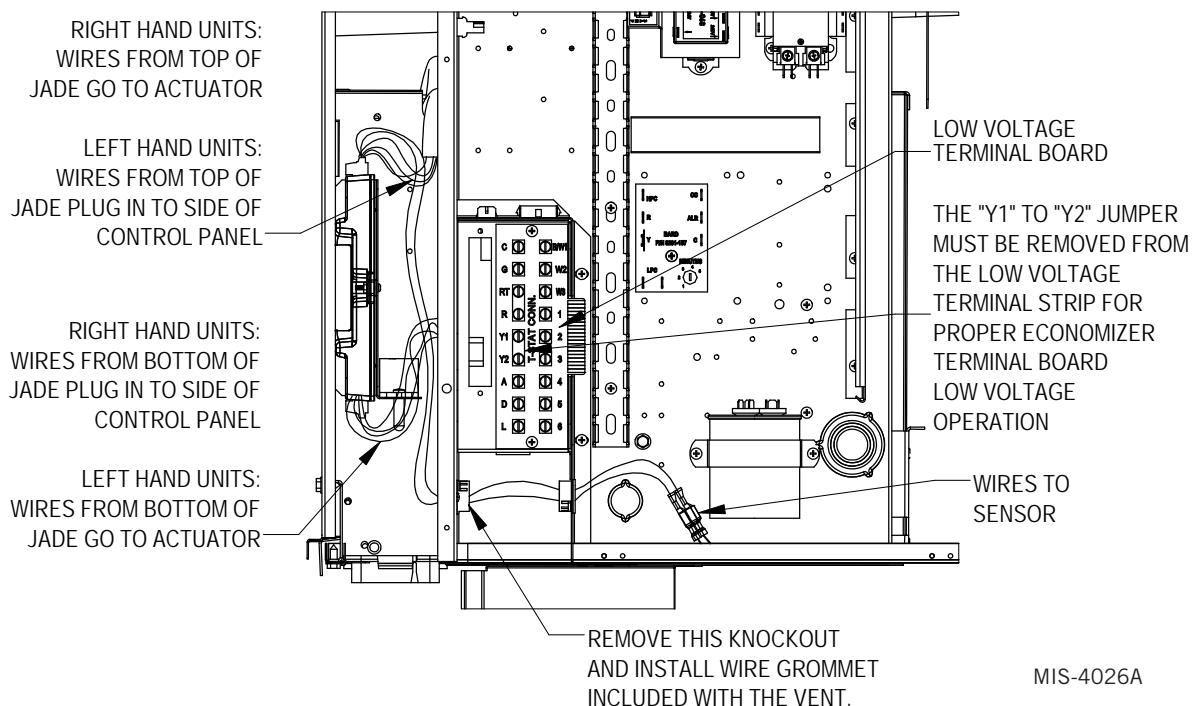

MIS-4026A

- Remove the Y1-Y2 jumper from the low voltage terminal strip (this jumper is already removed in units with factory-installed economizers). If Balanced Climate is desired, the secondary jumper must be removed from the vent harness by disconnecting the purple and yellow/white jumper in the vent harness.

FIGURE 7
Mixed Air Temperature Sensor Installation

FRONT VIEW

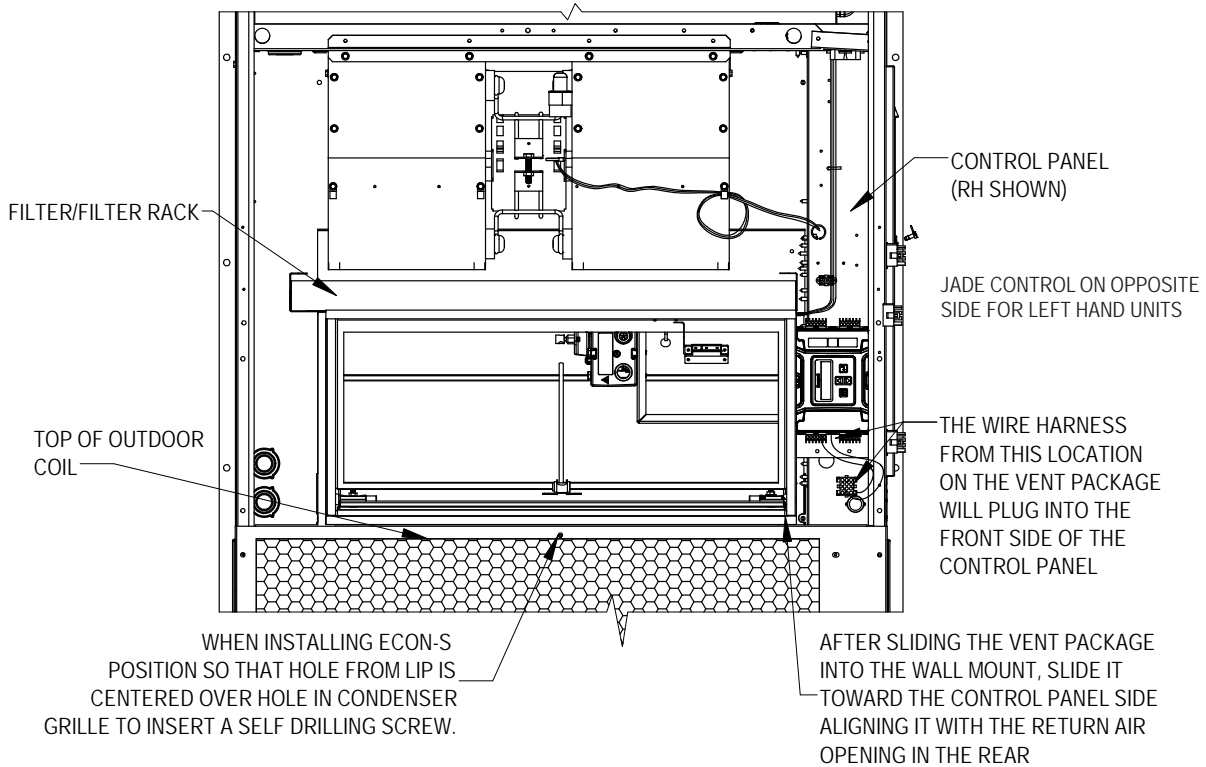

MIS-4019

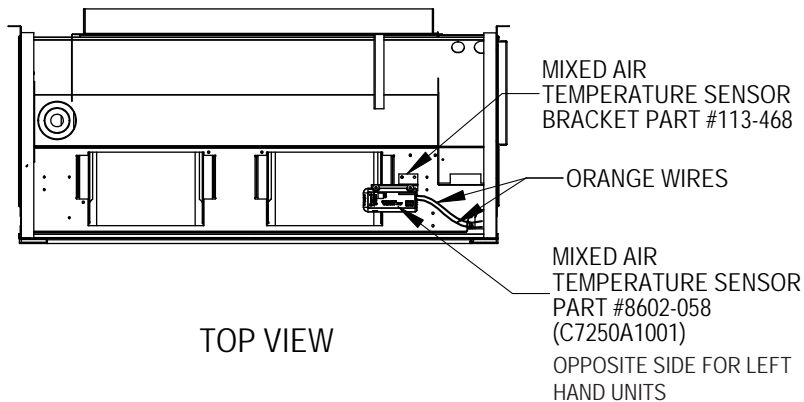

TOP VIEW

MIS-3622

Economizer Checkout

1. Complete economizer checkout using economizer control touchpad (see **CHECKOUT** on page 16).
2. After confirming economizer operation, install the mist eliminator (as shown in Figure 8—with airflow arrow pointed towards unit) and blower, filter and vent access panels.

FIGURE 8
Vent Option Door Installation

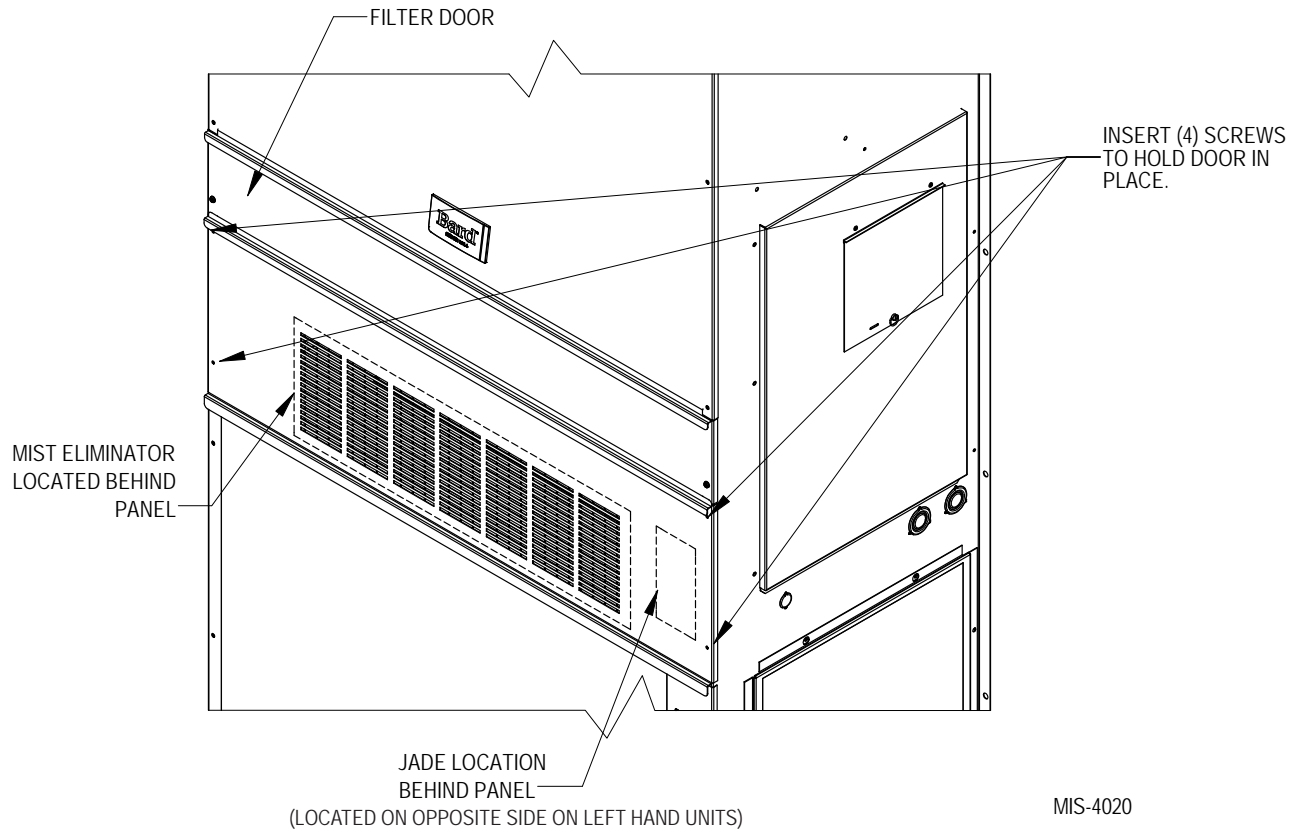

Control Wiring Connection Diagrams

The control wiring diagrams in Figures 9 – 12 represent typical control wiring for single units controlled by individual thermostats. If thermostats other than those referenced are used, the installer must verify output functions accordingly.

For dual unit installation utilizing lead/lag controller systems, complete details are contained in MC4002 Series Lead/Lag Controller installation manual 2100-614. For operation with MV5000 lead/lag controller, see MV5000 installation manual 2100-636.

FIGURE 9
Programmable Thermostat Connections for Air Conditioner with Economizer

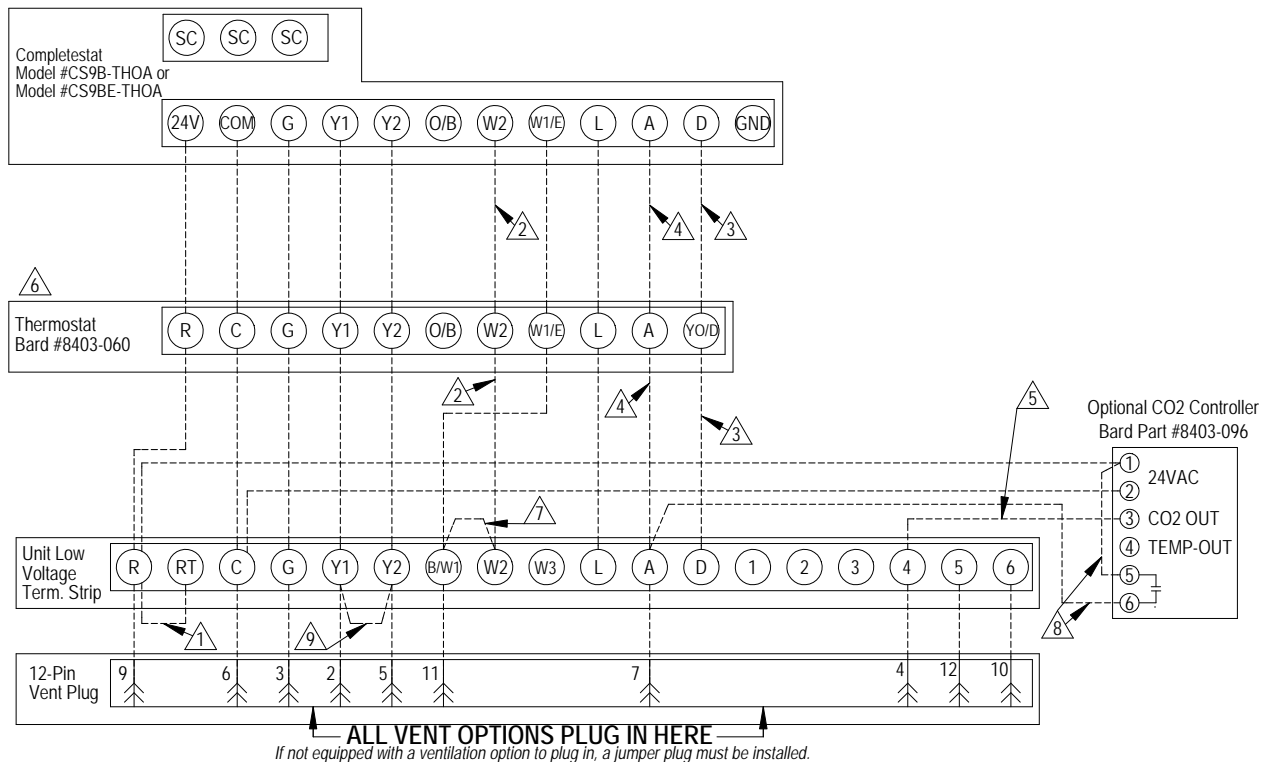

ALL VENT OPTIONS PLUG IN HERE
If not equipped with a ventilation option to plug in, a jumper plug must be installed.

- ① Factory installed jumper. Remove jumper and connect to N.C fire alarm circuit if emergency shutdown required.
- ② Wire not needed below 15KW.
- ③ Wire required for dehumidification models only.
- ④ Do not connect "A" from thermostat if optional CO2 controller is used
- ⑤ 0-10 VDC modulating CO2 control signal for modulating ventilation control (optional for ECON only)
- ⑥ Change model configuration from heat pump to heat/cool. Must be configured to programmable and fan set to be programmed fan for the "A" output to function during scheduled occupied periods. Must be configured for multi-stage for Y1 output to be active 1st stage cooling. For dehumidification, must be configured for "No Economizer" for YO/D to be active for humidity control.
- ⑦ Install jumper for 1 stage electric heat on units with less than 15KW
- ⑧ Do not add these wires if setting up for modulating control. See note 6.
- ⑨ Factory installed jumper. Remove jumper to activate Balanced Climate™ mode. A 2-stage thermostat is recommended for Balanced Climate mode.

MIS-4080 B

FIGURE 10
Programmable Thermostat Connections for Heat Pump with Economizer

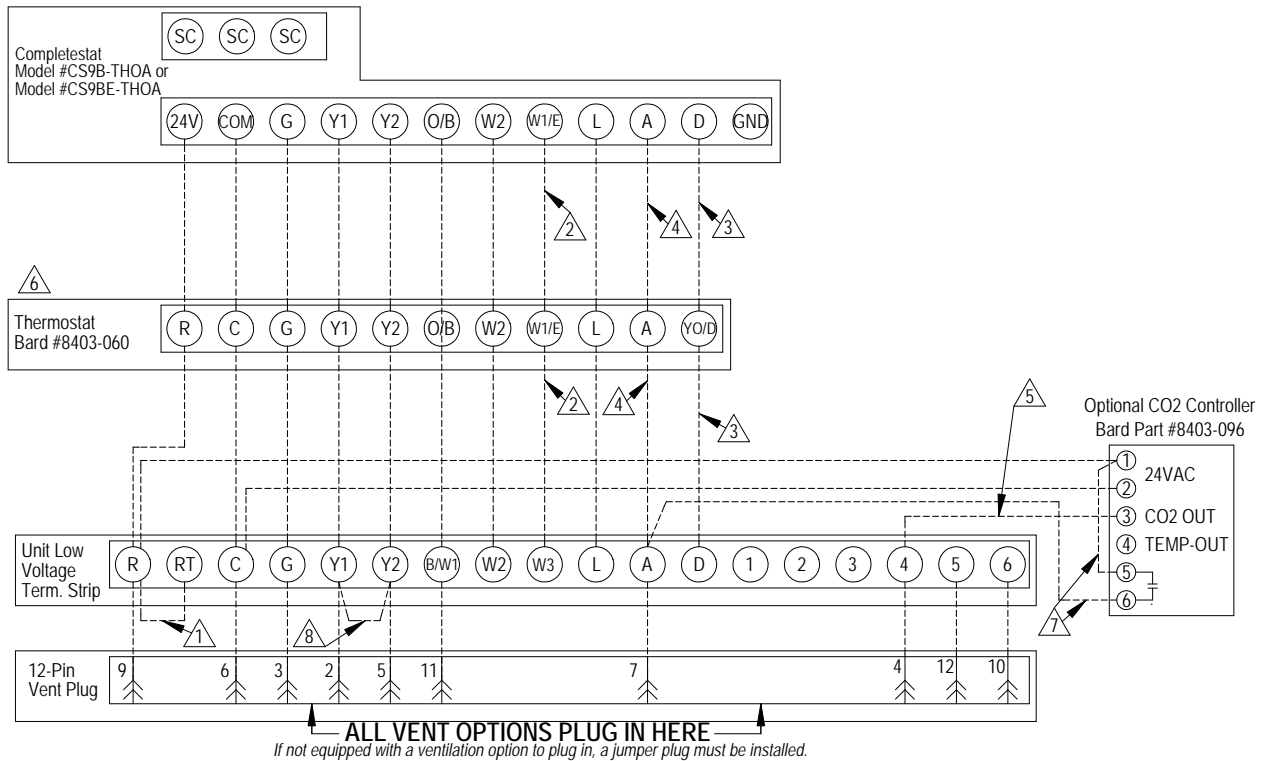

ALL VENT OPTIONS PLUG IN HERE
If not equipped with a ventilation option to plug in, a jumper plug must be installed.

- | | |
|--|--|
| <ul style="list-style-type: none"> △1 Factory installed jumper. Remove jumper and connect to N.C fire alarm circuit if emergency shutdown required. △2 Wire not needed below 15KW. △3 Wire required for dehumidification models only. △4 Do not connect "A" from thermostat if optional CO2 controller is used △5 0-10 VDC modulating CO2 control signal for modulating ventilation control (optional for ECON only - see vent instruction manuals) | <ul style="list-style-type: none"> △6 Ensure model configuration is heat pump and not heat/cool. Must be configured to programmable and fan set to be programmed fan for the "A" output to function during scheduled occupied periods. Must be configured for multi-stage for Y1 output to be active 1st stage cooling. For dehumidification, must be configured for "No Economizer" for YO/D to be active for humidity control. △7 Do not add these wires if setting up for modulating control. △8 Factory installed jumper. Jumper is not installed on unit with economizers. Jumper is located in jade wiring harness. |
|--|--|

MIS-4063 D

FIGURE 11
Non-Programmable Thermostat Connections for Air Conditioner with Economizer

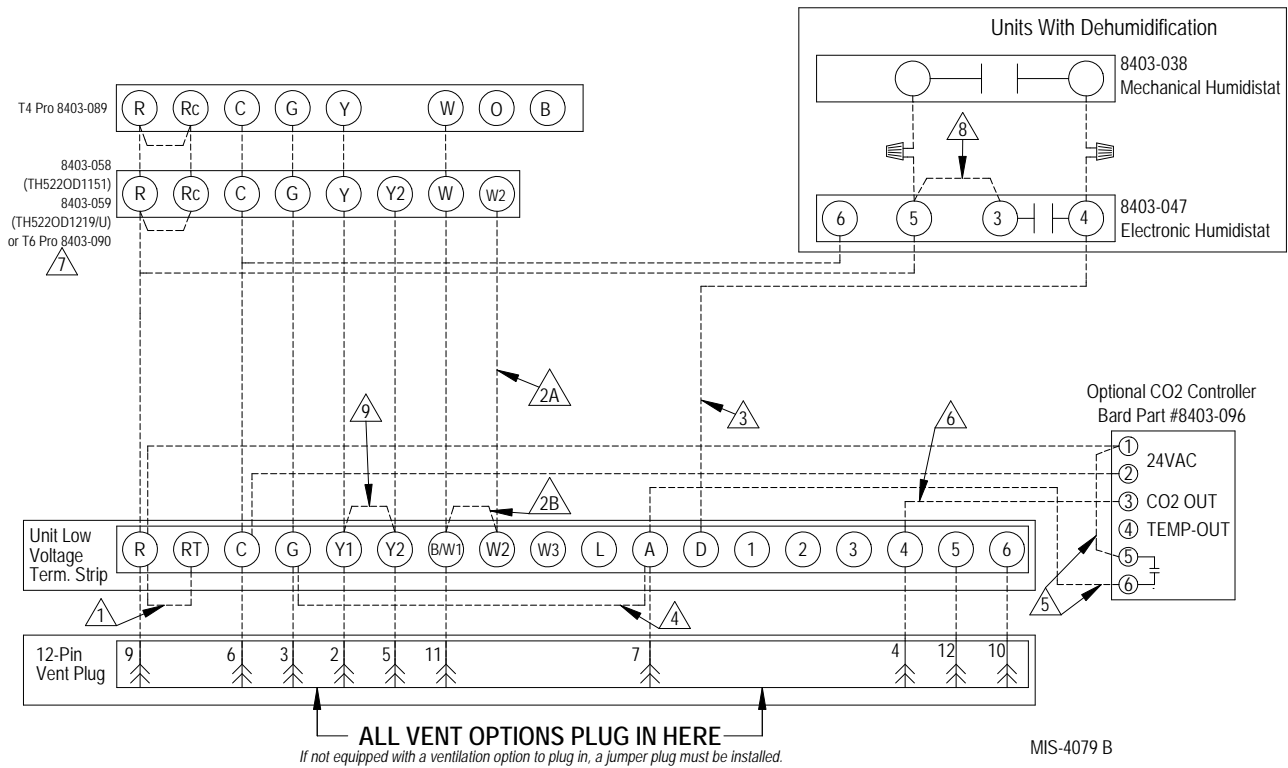

- ⚠ Factory installed jumper. Remove jumper and connect to N.C fire alarm circuit if emergency shutdown required.
- ⚠ Wire not needed below 15KW.
- ⚠ Install Jumper for 1 stage electric heat on units with more than 10KW.
- ⚠ Wire required for dehumidification models only.
- ⚠ For vent operation, add jumper if optional CO2 controller is not used. Vent will run while blower is energized.
- ⚠ Do not add these wires if setting up for modulating control. See note 6.
- ⚠ 0-10 VDC Modulating CO2 control signal for modulating ventilation control (Optional for ECON Only)
- ⚠ For 8403-058, change "system type", set up Function 1, From 5 (2 Heat/ 1 Cool heat Pump) to 6 (2 Heat / 2 Cool Conventional). For 8403-059, No change required.
- ⚠ Jumper needs added.
- ⚠ Factory installed jumper. Remove jumper to activate Balanced Climate™ Mode. A 2-stage thermostat is recommended for Balanced Climate mode.

IMPORTANT NOTE

An additional wire change is required if jumper **4** is used which connects "A" to "G" (shown on Figures 11 and 12). The red/white wire on the blower interlock relay (located on the vent control plate) needs to be moved from the "common" terminal to the "normally closed" terminal. **If this change is not made, the relay will latch on once the "A" signal is received and the blower will not turn off.** Refer to page 27 to see the vent wiring diagram with this change called out.

FIGURE 12
Non-Programmable Thermostat Connections for Heat Pump with Economizer

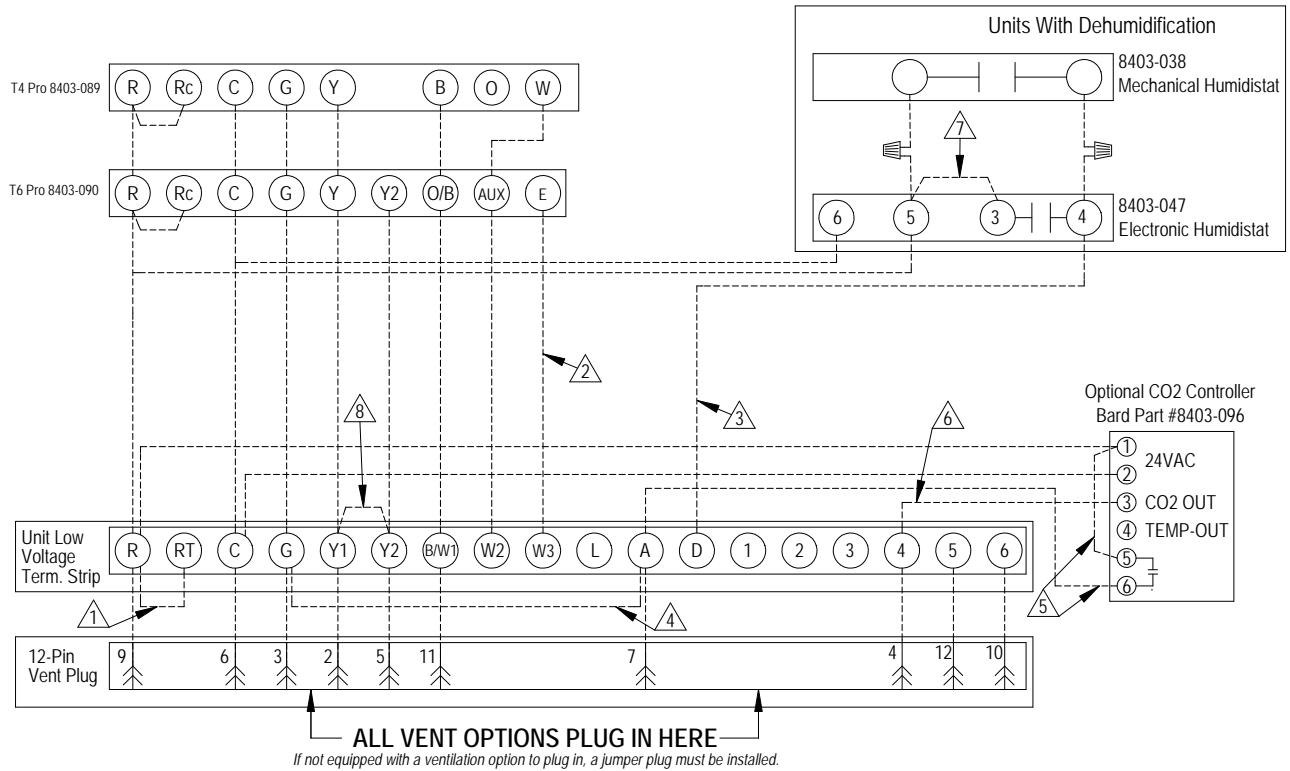

ALL VENT OPTIONS PLUG IN HERE
 If not equipped with a ventilation option to plug in, a jumper plug must be installed.

- | | |
|--|---|
| <p>1 Factory installed jumper. Remove jumper and connect to N.C fire alarm circuit if emergency shutdown required.</p> <p>2 Wire not needed below 15KW.</p> <p>3 Wire required for dehumidification models only.</p> <p>4 For vent operation, add jumper if optional CO2 controller is not used. Vent will run while blower is energized. For ECON & CRV-V, an additional wire change is required. See install manual.</p> <p>5 Do not add these wires if setting up for modulating control. See note 6.</p> | <p>6 0-10 VDC Modulating CO2 control signal for modulating ventilation control (Optional for ECON Only) - See vent installation manual.</p> <p>7 Jumper needs added.</p> <p>8 Factory installed jumper. Jumper is not installed on unit with economizers. Jumper is located in jade wiring harness.</p> |
|--|---|

MIS-4122 C

IMPORTANT NOTE

An additional wire change is required if jumper 4 is used which connects "A" to "G" (shown on Figures 11 and 12). The red/white wire on the blower interlock relay (located on the vent control plate) needs to be moved from the "common" terminal to the "normally closed" terminal. **If this change is not made, the relay will latch on once the "A" signal is received and the blower will not turn off.** Refer to page 27 to see the vent wiring diagram with this change called out.

START-UP/CHECKOUT PROCEDURES

JADE™ Economizer Controller

W7220 controller offers unparalleled flexibility and expansion in a dependable and solid electronic platform.

- Multiple economizer applications from one controller.
- Nearly limitless customization of setpoints.
- Internal checkout menu provides fast performance assessment.
- Alarms menu provides assistance in troubleshooting.

Memory: User-defined setpoints remain in non-volatile flash memory regardless of electrical outage duration. Control voltage below 18V may cause erratic performance.

FIGURE 13
JADE™ Economizer Controller

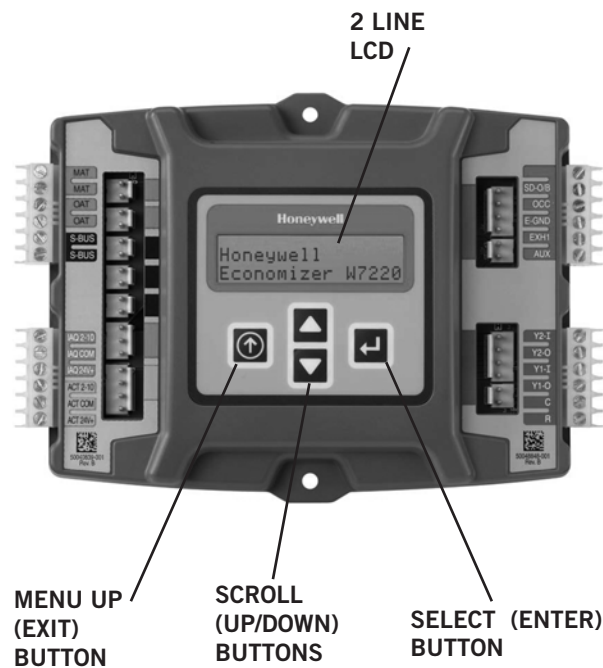

From the factory, the JADE™ economizer controller has been preset with “default” values that were pre-determined as optimum for equipment buildings, and these are shown in Tables 2 – 4. However, it is important to review and/or customize these operational values per owner specifications in order to guarantee satisfactory performance.

The installing contractor can easily access the JADE™ programming by the integral keypad and LCD display.

There are six (6) basic MENU categories to navigate:

1. **STATUS** – provides real-time access to sensor input, damper and equipment operation.
2. **SETPOINTS** – customizable operational parameters.
3. **SYSTEM SETUP** – customizable application programming (see Review/Customize System Setup).
4. **ADVANCED SETUP** – further application and operational options.
5. **CHECKOUT** – instantly activate and verify economizer functions.
6. **ALARMS** – displays alarms and pinpoints problem areas.

Review/Customize System Setup

Before being placed in service, the JADE™ economizer controller programming should be reviewed/customized through the following steps:

1. **SYSTEM SETUP:** from the main screen, press the **SCROLL (UP/DOWN) BUTTONS** to navigate through the six (6) basic menu items to the **SYSTEM SETUP** menu.
 - Push the **SELECT (ENTER) BUTTON** to choose the **SYSTEM SETUP** menu.
 - Navigate through the multiple levels of **SYSTEM SETUP** by pushing the **SCROLL (UP/DOWN) BUTTONS**.
 - To change a specific parameter in the **SYSTEM SETUP** menu, press the **SELECT (ENTER) BUTTON** to display its current value. Press the **SCROLL (UP/DOWN) BUTTONS** to change or increase/decrease value. Press the **SELECT (ENTER) BUTTON** to save the new customized value—“CHANGE STORED” will be displayed. Press the **SELECT (ENTER) BUTTON** again to return to current menu parameter.
 - For specific **SYSTEM SETUP** level information, refer to **Table 2**.

NOTE: During an extended level of inactivity, the display of the JADE™ economizer controller will begin to automatically scroll through the various levels of the STATUS menu as a screensaver. Each level will stay for approximately 5 seconds before changing to the next level.

TABLE 2
System Setup Menu Levels

| Menu Level | Default Value | Range | Notes |
|-----------------|---------------|----------------------------|---|
| INSTALL | 01/01/10 | | Display Order = MM/DD/YY Setting Order = DD/MM/YY |
| UNITS DEG | °F | °F / °C | Sets controller to read in either measurements |
| EQUIPMENT | HP(B) | HP | Heat Pump HP * CONV = A/C |
| AUX IN | HP(B) | HP(O) HP(B) | Energize on Cool * Energize on Heat |
| FAN SPEED | 1 Speed | 1 Speed 2 Speed | |
| FAN CFM | 5000 | 100 to 15000 | Not applicable |
| AUX OUT | EXH2 | NONE ERV EXH2 SYS | Product can be used to signal other devices |
| OCC | INPUT | INPUT or ALWAYS | INPUT is for dedicated OCC signal, ALWAYS is for all other situations |
| FACTORY DEFAULT | NO | YES or NO | Resets to factory defaults if changed to YES |

* In SYS SETUP, the correct Equipment setting is HP and for the AUX2 IN is HP (B) in all applications. This is correct for both air conditioner and heat pump equipment in order to have correct operating sequences for the economizers. DO NOT change to CONV = A/C setting just because the equipment is an air conditioner and not a heat pump.

2. **ADVANCED SETUP:** from the main screen, press the **SCROLL (UP/DOWN) BUTTONS** to navigate through the six (6) basic menu items to the **ADVANCED SETUP** menu.

- Push the **SELECT (ENTER) BUTTON** to choose the **ADVANCED SETUP** menu.
- Navigate through the multiple levels of **ADVANCED SETUP** by pushing the **SCROLL (UP/DOWN) BUTTONS**.
- To change a specific parameter in the **ADVANCED SETUP** menu, press the **SELECT (ENTER) BUTTON** to display its current value. Press the **SCROLL (UP/DOWN) BUTTONS** to change or increase/decrease value. Press the **SELECT (ENTER) BUTTON** to save the new customized value—“CHANGE STORED” will be displayed. Press the **SELECT (ENTER) BUTTON** again to return to current menu parameter.
- For specific **ADVANCED SETUP** level information, refer to **Table 3**.

TABLE 3
Advanced Setup Menu Levels

| Menu Level | Default Value | Range | Notes |
|------------|---------------|------------------------------|--|
| MA LOW SET | 45°F | 35-55° | Temp to activate freeze protection — Close Damper |
| FREEZE POS | CLO | CLO or MIN | Damper position upon freeze protection |
| STG3 DLY | 15 MIN | 0 to 4.0h or OFF | Delay for 3rd Stage Cooling – allows for 3 stages of cooling, one stage for econ & two stages for compressor |
| DMPR POS | CLO | CLO or OPN | Where damper goes upon shutdown signal |
| MA T CAL | 0.0°F | +/-2.5°F from actual reading | Mixed Air Sensor temperature calibration |
| OA T CAL | 0.0°F | +/-2.5°F from actual reading | Outdoor Air Sensor temperature calibration |
| OAS H CAL | 0% | +/-10% from actual reading | Outdoor Air Humidity Sensor calibration for economizers using temp/humidity sensor |

3. **SETPOINTS:** from the main screen, press the **SCROLL (UP/DOWN) BUTTONS** to navigate through the six (6) basic menu items to the **SETPOINTS** menu.

- Push the **SELECT (ENTER) BUTTON** to choose the **SETPOINTS** menu.
- Navigate through the multiple levels of **SETPOINTS** by pushing the **SCROLL (UP/DOWN) BUTTONS**.
- To change a specific parameter in the **SETPOINTS** menu, press the **SELECT (ENTER) BUTTON** to display its current value. Press the **SCROLL (UP/DOWN) BUTTONS** to change or increase/decrease value. Press the **SELECT (ENTER) BUTTON** to save the new customized value—“CHANGE STORED” will be displayed. Press the **SELECT (ENTER) BUTTON** again to return to current menu parameter.
- For specific **SETPOINTS** level information, refer to **Table 4** on page 16.

NOTE: At this point, the economizer assembly should be fully functional and ready for preliminary testing.

**TABLE 4
Setpoints Menu Levels**

| Menu Level | Default Value | Range | Notes |
|---|---------------|---------------------------|---|
| MAT SET | 53°F | 38°F to 65°F | Mixed Air Temperature setpoint at which the economizer damper will begin to modulate to maintain setting |
| LOW T LOCK | 0°F | -45°F to 80°F | Low outdoor ambient temperature for compressor lockout |
| DRYBLB SET | 60°F | 48°F to 80°F | Maximum outdoor temperature setting for “free” economizer cooling |
| ENTH CURVE | ES3 | ES1, ES2, ES3, ES4 or ES5 | Enthalpy boundary “curves” for economizers using temp/humidity sensor, see “Enthalpy Settings” explanation |
| MIN POS | 2V | 2 to 10 VDC | Actuator voltage for Minimum Position – see Minimum Position Note |
| EXH1 | 50% | 0 to 100% | Setpoint for damper if exhaust fan is powered by economizer |
| EXH2 | 6% | 0 to 100% | Setpoint for AUX output signal |
| DCV SET (See NOTE under Table 7 on page 17) | 1100 | 500 to 2000 | Displays only if a CO ₂ sensor is connected. Setpoint for Demand Control Ventilation of space. Above the setpoint, the OA dampers will modulate open to bring in additional OA to maintain a space ppm level below the setpoint. |

MINIMUM POSITION NOTE: *Minimum position setting has been preset to 10V which when connected to MC4002 Lead/Lag Controller System will allow economizer to drive wide open per emergency ventilation strategy as detailed in MC4002 Instructions. This may require resetting to a lower value per job specifications.*

4. **CHECKOUT:** from the main screen, press the **SCROLL (UP/DOWN) BUTTONS** to navigate through the six (6) basic menu items to the **CHECKOUT** menu.

- Push the **SELECT (ENTER) BUTTON** to choose the **CHECKOUT** menu.
- Navigate through the multiple levels of **CHECKOUT** by pushing the **SCROLL (UP/DOWN) BUTTONS**.
- To perform a specific test in the **CHECKOUT** menu, press the **SELECT (ENTER) BUTTON** to choose a particular exercise, “**RUN?**” will appear. Press the **SELECT (ENTER) BUTTON** again to activate this exercise. After a short pause, “**IN PROGRESS**” will appear as the test activates. “**DONE**” will display after the test is complete. Press the **MENU UP (EXIT) BUTTON** to end the test and/or turn off the activated relay.
- For specific **CHECKOUT** level information, refer to **Table 5**.

NOTE: CHECKOUT functions bypass the normal 5-minute delay for compressor protection. Be sure to allow for enough time to pass between tests so the compressor is not damaged from extreme short-cycling.

**TABLE 5
Checkout Menu Levels**

| Menu Level | Notes |
|----------------|--|
| DAMPER VMIN-HS | Positions damper to the minimum amount of opening allowed by actuator |
| DAMPER VMAX-HS | Opens damper to the MIN POS level indicated in the SETPOINTS menu. See Minimum Position Note above. |
| DAMPER OPEN | Forces damper to full open position, energizes exhaust contacts |
| DAMPER CLOSE | Positions damper to completely closed position |
| CONNECT Y1-0 | Forces Y1-OUTPUT to compressor |
| CONNECT Y2-0 | Forces Y2-OUTPUT to compressor |
| CONNECT EXH1 | Setpoint for damper if exhaust fan is powered by economizer |
| CONNECT EXH2 | Setpoint for AUX output signal |
| CONNECT AUX | Depending upon AUX OUT setting from SYSTEM SETUP menu: NONE – no action ERV – 24VAC out for ERV & NOT Economizer SYS – 24VAC out for alarm |

NOTE: Economizer assembly should be ready to put into service. At any point during operation, in economizer mode or idle, real-time information from sensors and integral components can be accessed from the **STATUS** menu.

5. **STATUS:** from the main screen, press the **SCROLL (UP/DOWN) BUTTONS** to navigate through the six (6) basic menu items to the **STATUS** menu.

- Push the **SELECT (ENTER) BUTTON** to choose the **STATUS** menu.
- Navigate through the multiple levels of **STATUS** by pushing the **SCROLL (UP/DOWN) BUTTONS**.
- As the **STATUS** menu simply gives input/output information in real-time, there is no way to change or otherwise alter the displayed criteria. It is simply a window into the operation of the economizer controller.
- For specific **STATUS** level information, refer to **Table 6**.

NOTE: Upon power-up (or after power failure or low voltage condition), the controller will begin a 5-minute time delay before enabling mechanical cooling.

TABLE 6
Status Menu Levels

| Menu Level | Default Value | Notes |
|--------------|---------------|--|
| ECON AVAIL | YES/NO | Indicates if conditions are favorable for economizing |
| ECONOMIZING | YES/NO | Indicates if economizer is actively economizing |
| OCCUPIED | YES/NO | Indicates if dedicated 24V occupied signal is being received on terminal OCC |
| HEAT PUMP | COOL/HEAT | Displays actual compressor use if in HEAT PUMP mode |
| COOL Y1-IN | ON/OFF | Indicates if 24V signal is being received on terminal Y1-I |
| COOL Y1-OUT | ON/OFF | Displays if controller is actively calling for mechanical compressor cooling (24V on Y1-O) |
| COOL Y2-IN | ON/OFF | Indicates if 24V signal is being received on terminal Y2-I |
| COOL Y2-OUT | ON/OFF | Displays if controller is actively calling for Stg. 2 cooling (24V on Y2-O) |
| MA TEMP | 0° to 140°F | Current mixed air temp |
| OA TEMP | -40° to 140°F | Current outdoor air temp |
| OA HUM | 0% to 100% | Current outdoor air humidity for economizers using temp/humidity sensor |
| DAMPER OUT | 2.0 to 10.0 | Displays voltage to actuator |
| ACT POS | 0 to 100% | Current % of opening |
| ACT COUNT | N/A | Current count of actuator cycles from installation |
| ACTUATOR OK | YES/NO | Indicates potential fault |
| EXH1 OUT | ON/OFF | Output of EXH1 Terminal |
| MECH COOL ON | 0, 1, or 2 | Stages of mechanical cooling currently active |

NOTE: If there are any potential problems recognized by the economizer controller, it may be registered in the form of an alarm in the **ALARM(S)** menu. If there is a period of inactivity AND there is an alarm registering, the controller will randomly scroll through the **ALARM(S)** menu items as a screensaver.

ALARM(S): from the main screen, press the **SCROLL (UP/DOWN) BUTTONS** to navigate through the six (6) basic menu items to the **ALARM(S)** menu.

- Push the **SELECT (ENTER) BUTTON** to choose the **ALARM(S)** menu.
- Navigate through the current alarms in **ALARM(S)** by pushing the **SCROLL (UP/DOWN) BUTTONS**.
- Once the alarm has been identified, and the cause has been removed (e.g., replaced faulty sensor), the alarm may erase itself. If a manual alarm-erasing is required, it can be cleared from the display by navigating to the desired alarm and pressing the **SELECT (ENTER) BUTTON** to choose that specific alarm. **“ERASE?”** will display. Press the **SELECT (ENTER) BUTTON** again. **“ALARM ERASED”** will appear. Press the **MENU UP (EXIT) BUTTON** to complete the action and return to the previous menu.
- For specific **ALARM(S)** information, refer to **Table 7**.

TABLE 7
Alarm Examples

| Alarm(s) | Notes |
|---|--|
| MA T SENS ERR | Malfunctioning mixed air sensor |
| OA T SENS ERR | Malfunctioning outdoor air sensor |
| ACT STALLED | Actuator cannot reach desired percentage of opening |
| SYS ALARM | If AUX is set to SYS in SETPOINTS menu, SYS will display upon any registered alarm |
| NOTE: This is not a complete list of alarms. Additional alarms will display depending upon the parameter settings and configuration and attached equipment. | |

NOTE: When using the Bard 8403-096 CO₂ controller, configure the sensor to 2-10VDC output (see CO₂ sensor instructions). See also Figure 17 on page 24.

The JADE controller default setting is 1100 PPM. The economizer will modulate to maintain this CO₂ level in the room. The default setting can be changed in the SETPOINT menu in the DCV SET option. Default settings and DCV MIN and DCV MAX will appear only when the CO₂ sensor is connected.

In the SETPOINT menu, change the MAX VENT setting to 9.5 volts.

The CO₂ controller is active at any time the A terminal is energized.

The status of the CO₂ input can be viewed at any time in the STATUS menu.

Enthalpy Settings

If economizer is enthalpy-based and was shipped with the temp/humidity sensor, the economizer must be programmed for the specific enthalpy curve boundary desired for “free” outdoor cooling. The available enthalpy boundaries are all subject to specific OA temperature, OA humidity and OA dew points. If all of the OA conditions are below the specific points outlined in each boundary, the conditions are good to economize and economizer mode is set to “YES”. If some or all the OA conditions are above the specific points outlined in each boundary, the conditions are not good to economize and the economizer mode is set to “NO”.

ES3 is factory default.

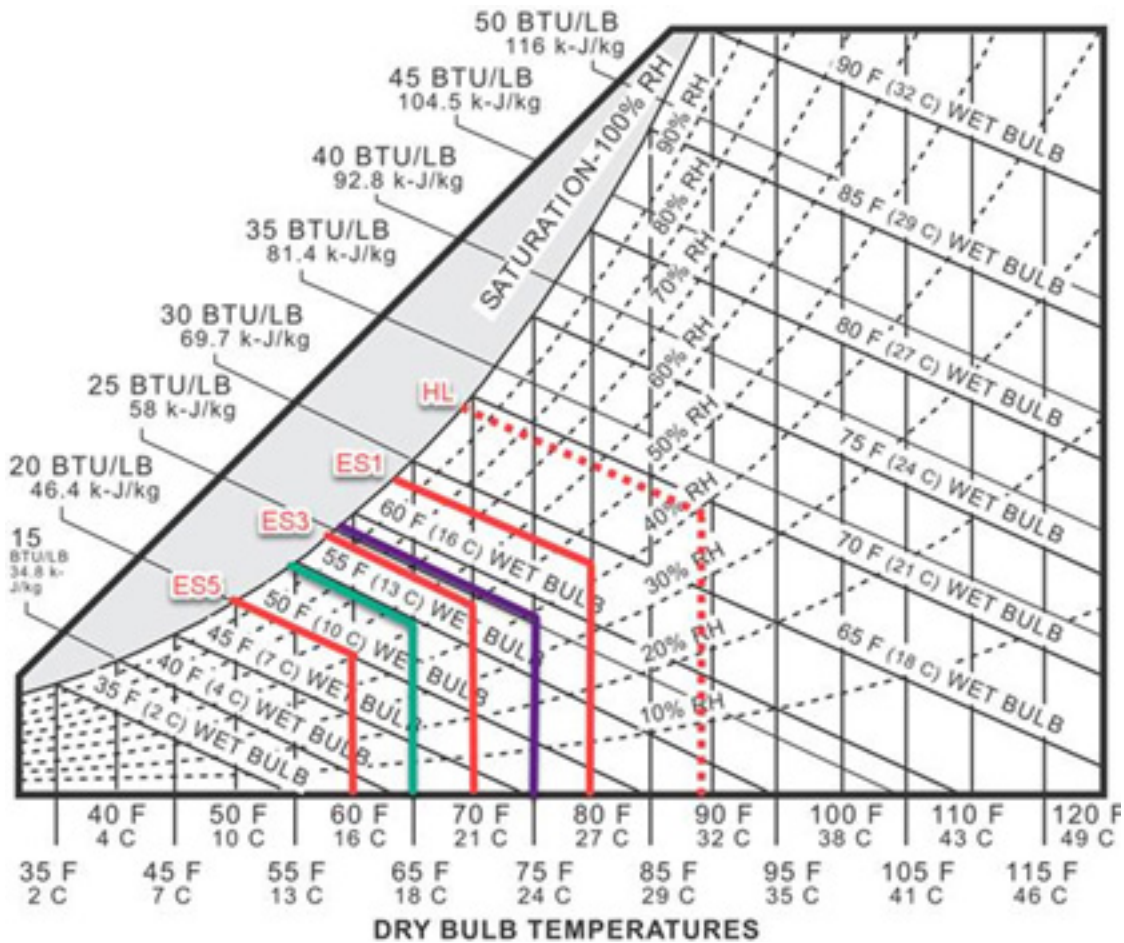

Economizer Sequence of Operation

Condition – Cool/Dry OA Conditions

- 1st Stage Cooling closes and sends signal to **JADE™** control. Since the air temperature outside is cooler than the preset **DRYBULB SET** setting, or is below the **ENTH CURVE** boundary in the **SETPOINTS** menu, the actuator will power the economizer damper to “economizer” mode as the indoor blower motor starts. The mixed air sensor senses a mixture of return air and cool outdoor air and modulates opening to achieve preset **MAT SET** setting in **SETPOINTS** menu. Compressor operation is inhibited (see Figure 14).
- 2nd Stage Cooling closes and sends a signal to **JADE™** control, which closes the Y1-O relay to begin mechanical cooling. **The economizer damper REMAINS OPEN in tandem operation with the compressor** as long as the OA conditions do not drop below the preset **DRYBULB SET/ENTH CURVE** settings in the **SETPOINTS** menu (see Figure 15).
- 3rd Stage Cooling (if available) closes and sends a signal to **JADE™** control, which closes the Y2-O relay to begin 2nd stage mechanical cooling. **The economizer damper REMAINS OPEN in tandem operation with the compressor** as long as the temperature outside does not drop below the preset **DRYBULB SET** setting in the **SETPOINTS** menu (see Figure 15).

Condition – Warm/Humid OA Conditions

- 1st Stage Cooling closes and sends signal to **JADE™** control. Since the OA conditions are above the preset **DRYBULB SET/ENTH CURVE** setting in the **SETPOINTS** menu, the control will simply close the Y1-O relay to initiate mechanical cooling. **The economizer damper will remain closed or in a minimum ventilation setting depending upon occupied status** (see Figure 16 on page 20).
- 2nd Stage Cooling (if available) closes and sends a signal to **JADE™** control. Since the OA conditions are still above than the preset **DRYBULB SET/ENTH CURVE** setting in the **SETPOINTS** menu, the control will simply close the Y2-O relay to initiate 2nd stage mechanical cooling. **The economizer damper will remain closed or in a minimum ventilation setting depending upon occupied status** (see Figure 16).

FIGURE 14
100% Outside Airflow Path

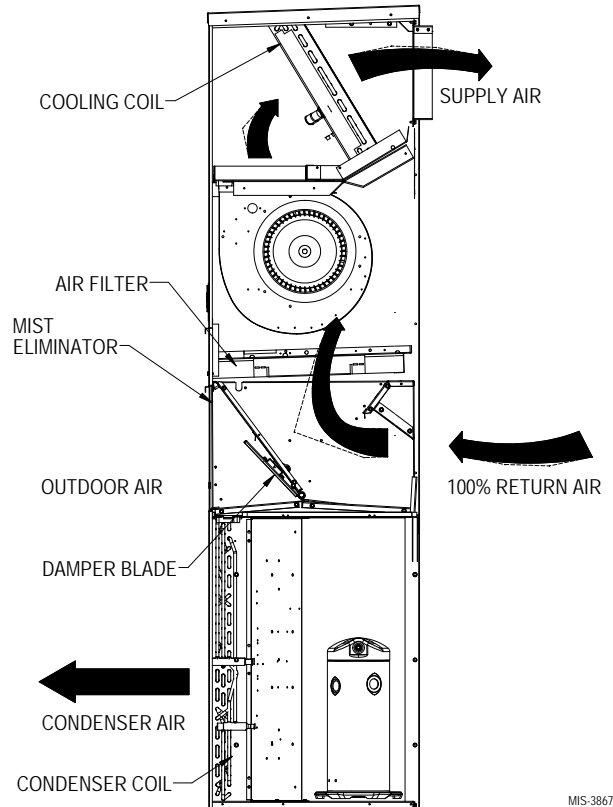

MIS-3867

FIGURE 15
Mixed Airflow Path

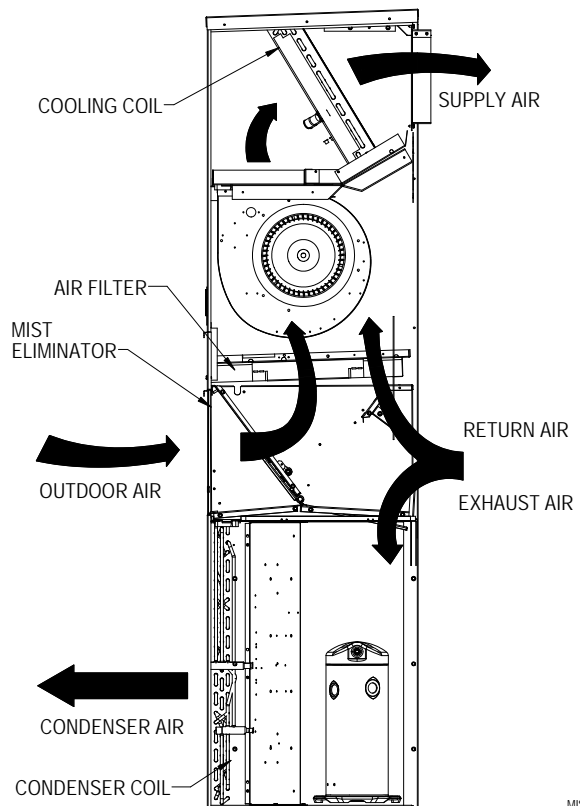

MIS-3866

FIGURE 16
100% Closed Loop Airflow Path

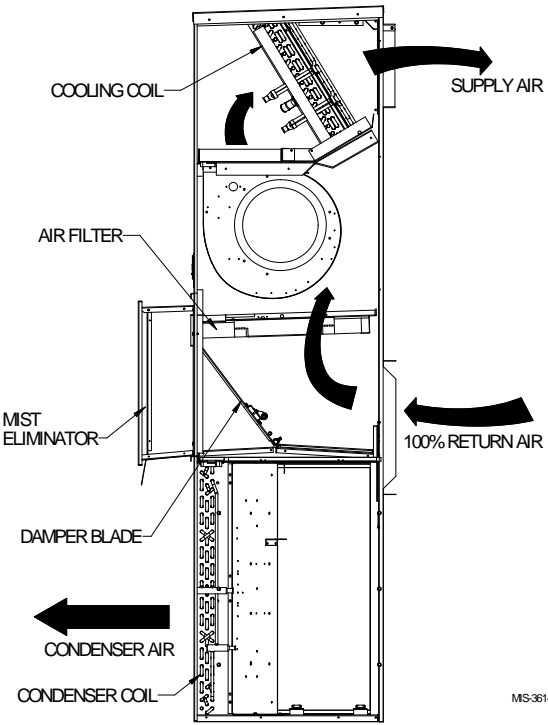

Economizer Operation for Single Stage:

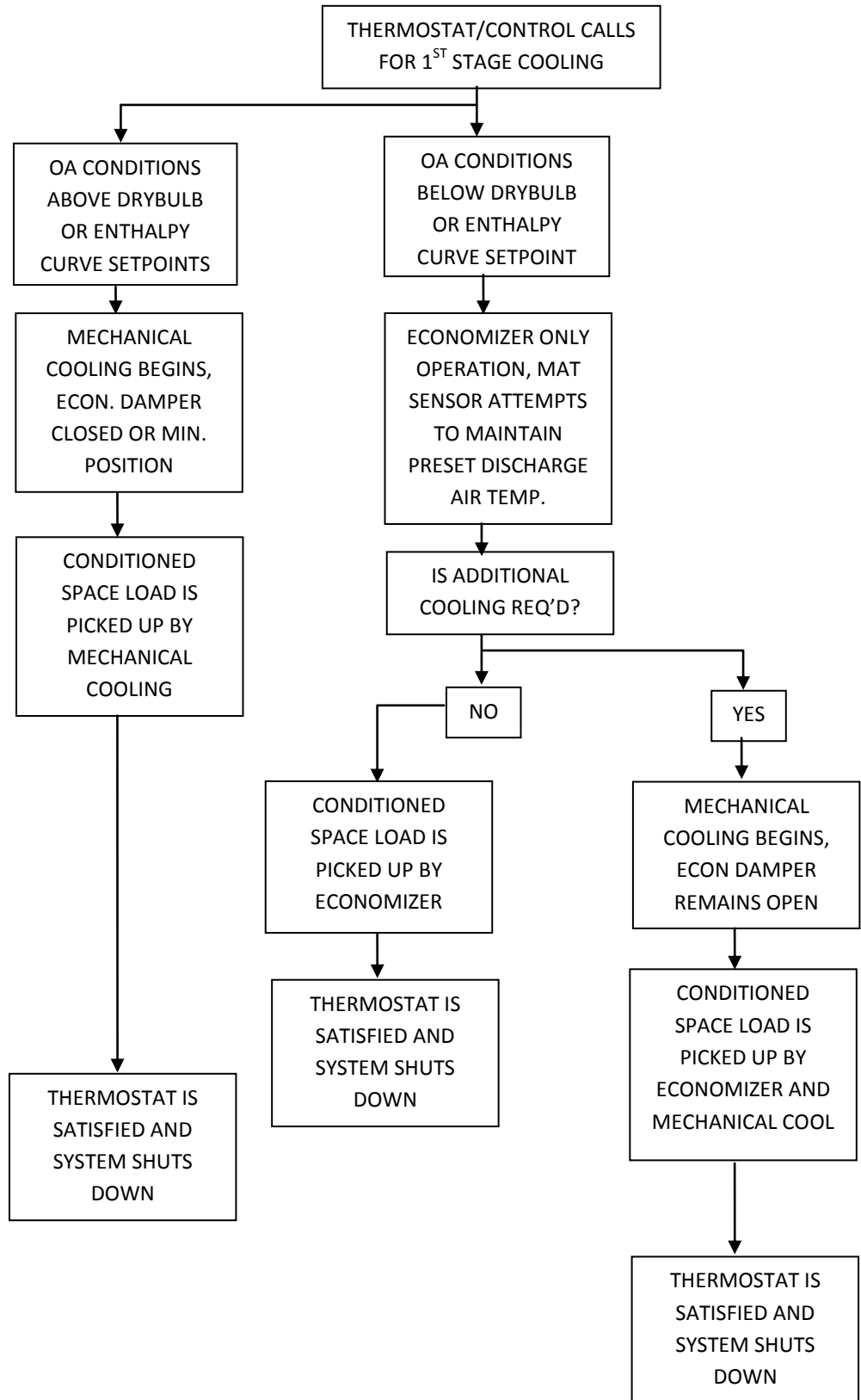

**Balanced Climate Mode – S, Y and Z Option
Economizer Sequence of Operation**

Balanced Climate can be used for duct free and ducted applications below 0.2" W.C. ESP total static.

**Call for cooling and ECONOMIZER IS NOT AVAILABLE
(due to outdoor conditions):**

Y1 energizes mechanical cooling and the Balanced Climate fan speed simultaneously. If the outdoor conditions are not acceptable, the Y2 terminal will energize the fan speed to the rated airflow. When the temperature drops below the Y2 setpoint, the unit will return to the Balanced Climate fan speed. When the cooling call is satisfied, the compressor will shut down and the economizer will move to minimum position (ventilation setting) and the fan will continue to run at RATED airflow if A is energized on the low voltage terminal strip.

Call for cooling and ECONOMIZER IS AVAILABLE (due to outdoor conditions):

Two stage cooling thermostat is required and connector is disconnected at JADE™ controller to enable Balanced Climate mode (see wiring diagram 4056-250* on page 27).

Unit has a call for ventilation: Damper to Min position and fan will run at RATED airflow. (When using Balanced Climate mode, increase the minimum position blade setting to allow 28% more outdoor air CFM than rated.) Y1 energizes economizer and the Balance Climate fan speed simultaneously. If the temperature continues to rise, the Y2 terminal will increase the fan speed to the RATED airflow. When the temperature drops below the Y2 setpoint, the unit will return to the Balanced Climate fan speed. When the cooling call is satisfied, the compressor will shut down and the economizer will move to minimum position (ventilation setting) and the fan will increase to run at RATED airflow if A is energized on the low voltage terminal strip.

**TABLE 8
Unit Operation with S (Part Flow), Y and Z (Full Flow) Economizer Options**

| Unit Operation | Occ. Signal | Low Voltage 24VAC | | | | | | | Speed Taps | | | Fan Speed | Comp. Oper. | Damper |
|-------------------------|-------------|-------------------|----|----|----|----|---|---|------------|---|--------------------|-----------|-------------|---------|
| | | G | Y1 | Y2 | W1 | W2 | A | D | 1 | 2 | 3-4-5 ¹ | | | |
| Fan Only | Yes | X | | | | | X | | X | | | Vent | Off | Min Pos |
| Fan Only | No | X | | | | | | | X | | | Vent | Off | Closed |
| BC Cooling | Yes | | X | | | | X | | X | X | | B Climate | Econ | Min Pos |
| BC Cooling | No | | X | | | | | | X | X | | B Climate | Econ | Closed |
| Full Load Cool | Yes | | X | X | | | X | | X | X | X | Lo/Med/Hi | On | Min Pos |
| Full Load Cool | No | | X | X | | | | | X | X | X | Lo/Med/Hi | On | Closed |
| 1st Stage Heat | Yes | | | | X | | X | | | | X | Lo/Med/Hi | Off | Min Pos |
| 1st Stage Heat | No | | | | X | | | | | | X | Lo/Med/Hi | Off | Closed |
| 2nd Stage Heat | Yes | | | | X | X | X | | | | X | Lo/Med/Hi | Off | Min Pos |
| 2nd Stage Heat | No | | | | X | X | | | | | X | Lo/Med/Hi | Off | Closed |
| Dehumidify ² | Yes | | | | | | X | X | X | X | | B Climate | On | Min Pos |
| Dehumidify ² | No | | | | | | | X | X | X | | B Climate | On | Closed |

BC and B Climate – Balanced Climate

- ¹ Fan speed is selectable through the blower speed control terminal block. LO (default), MED or HI speeds can be used.
- ² Dehumidification operation is disabled when a call for heating or cooling occurs. Unit runs at Balanced Climate speed during dehumidification operation.

FIGURE 17
CO₂ Sensor Default and Final Settings
Bard Part #8403-096 CO₂ Controller

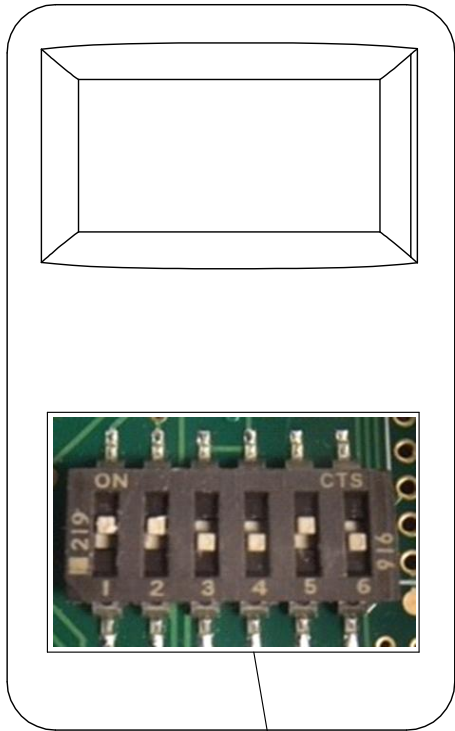

PRESS UP AND DOWN ARROWS TO ENTER CONFIGURATION MODE USE ARROWS TO SELECT SETTING. PUSH MIDDLE BUTTON TO CHANGE. CONTROLLER WILL SHOW SET.

NOTE: MENU DIP SWITCH MUST BE IN "ON" POSITION #5 TO CHANGE ANY SETTINGS WITH THE SIDE BUTTONS. TO LOCK THE CO₂ CONTROLLER MOVE DIP SWITCH TO "OFF" AFTER IT HAS BEEN CONFIGURED.

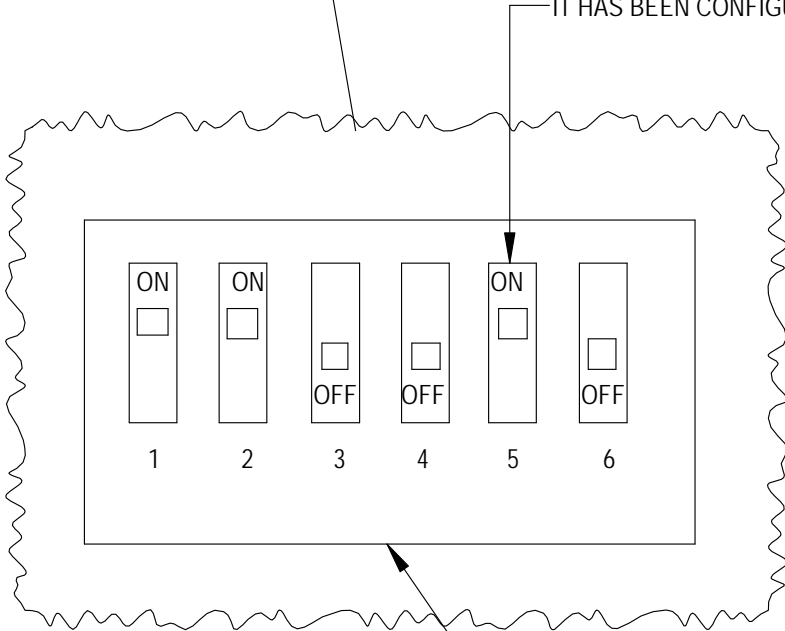
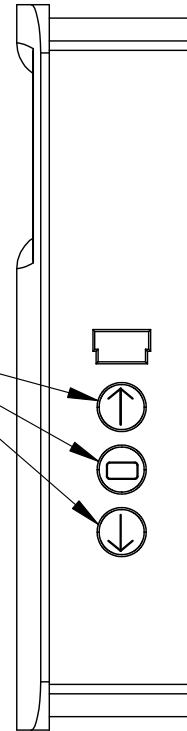

DIP SWITCHES MUST BE POSITIONED AS SHOWN FOR PROPER OPERATION

| Settings | Recommended | Default |
|----------|--|---------|
| RON | Not Used | |
| ROF | Not Used | |
| DSP | C | CT |
| UNI | US | US |
| COL | 700 | 0 |
| COH | 1500 | 2000 |
| TOL | Not Used | |
| TOH | Not Used | |
| BAR | See Instrution with Controller For High Altitude Installations | |
| CAL | Used for Field Calibration | |

MIS-4025 A

GRAPH 1
W18 Ventilation Delivery

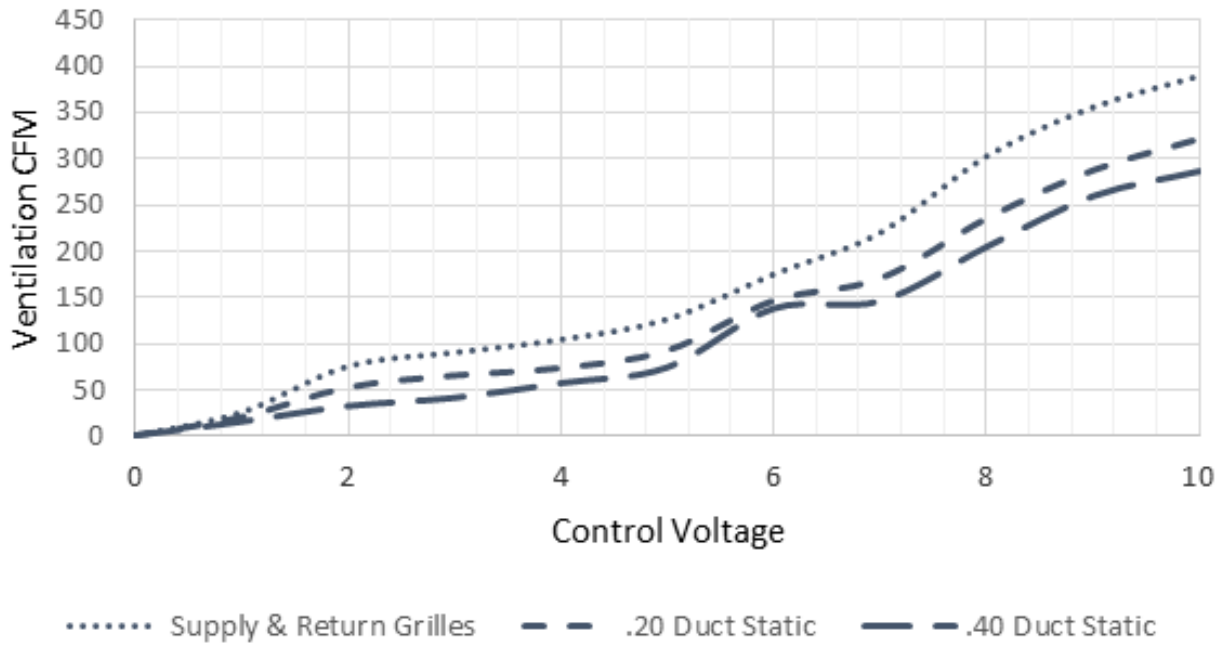

GRAPH 2
W24 Ventilation Delivery

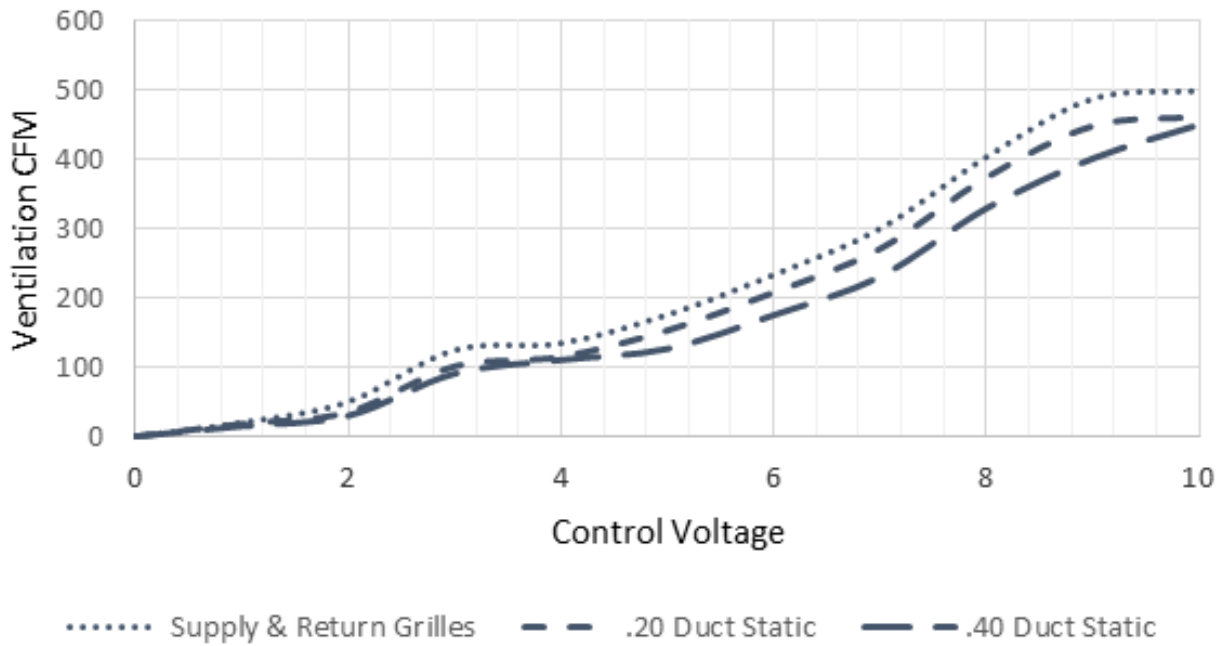

GRAPH 3
W30 Ventilation Delivery

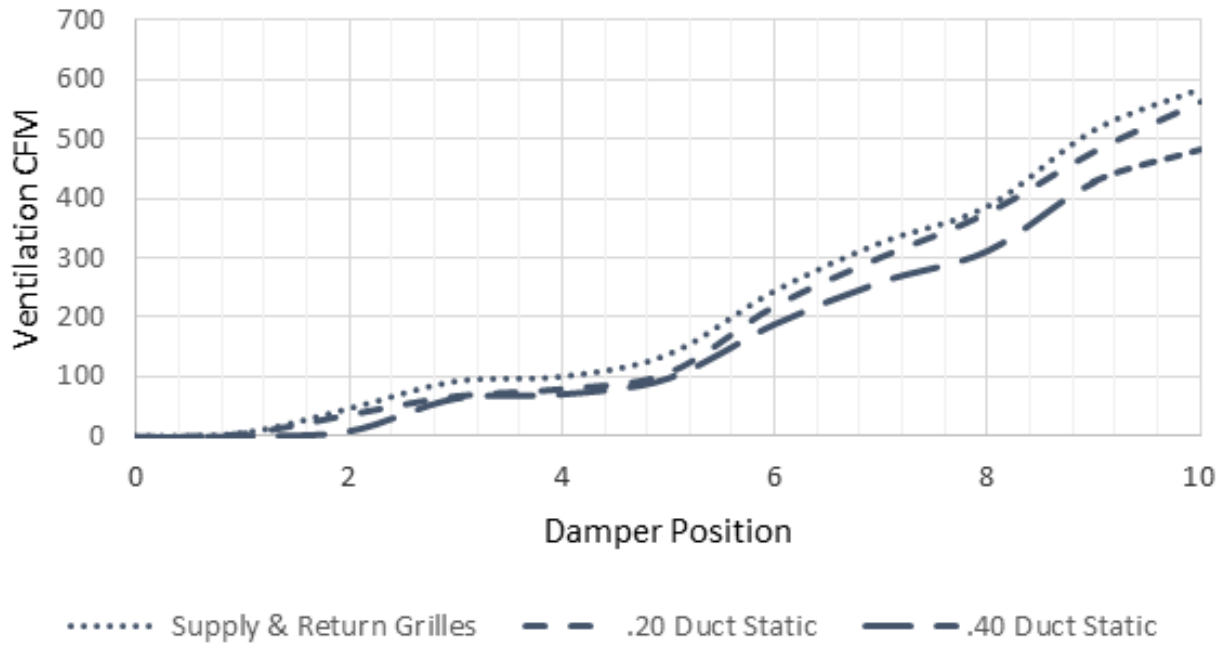

GRAPH 4
W36 Ventilation Delivery

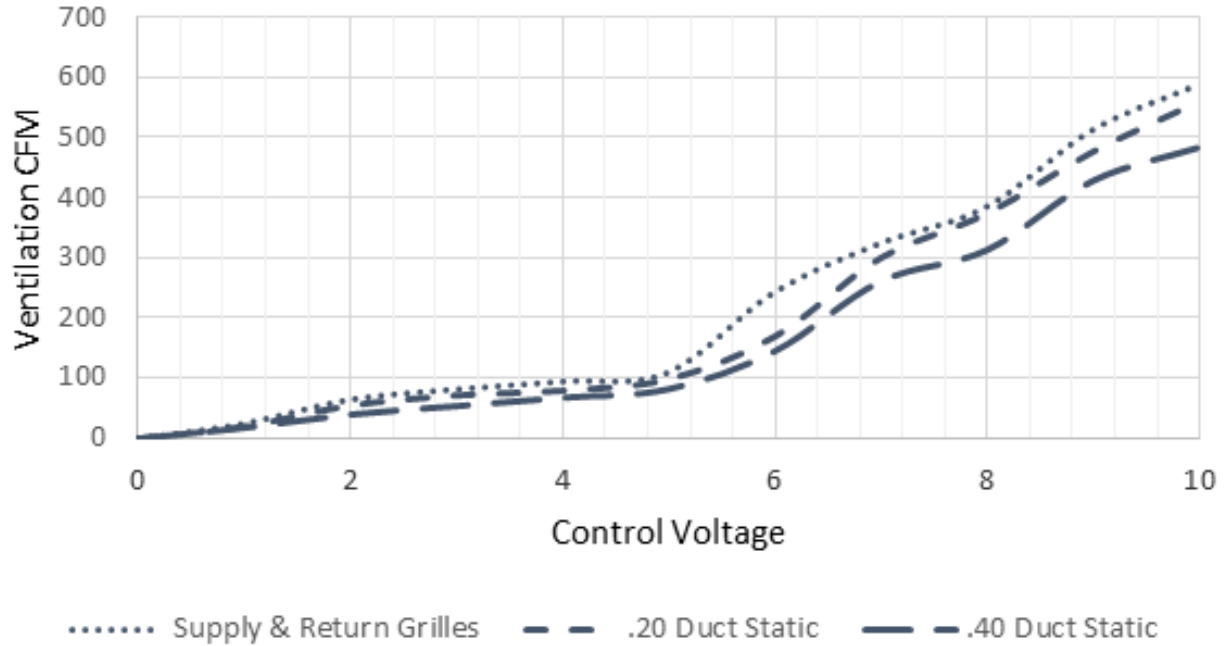
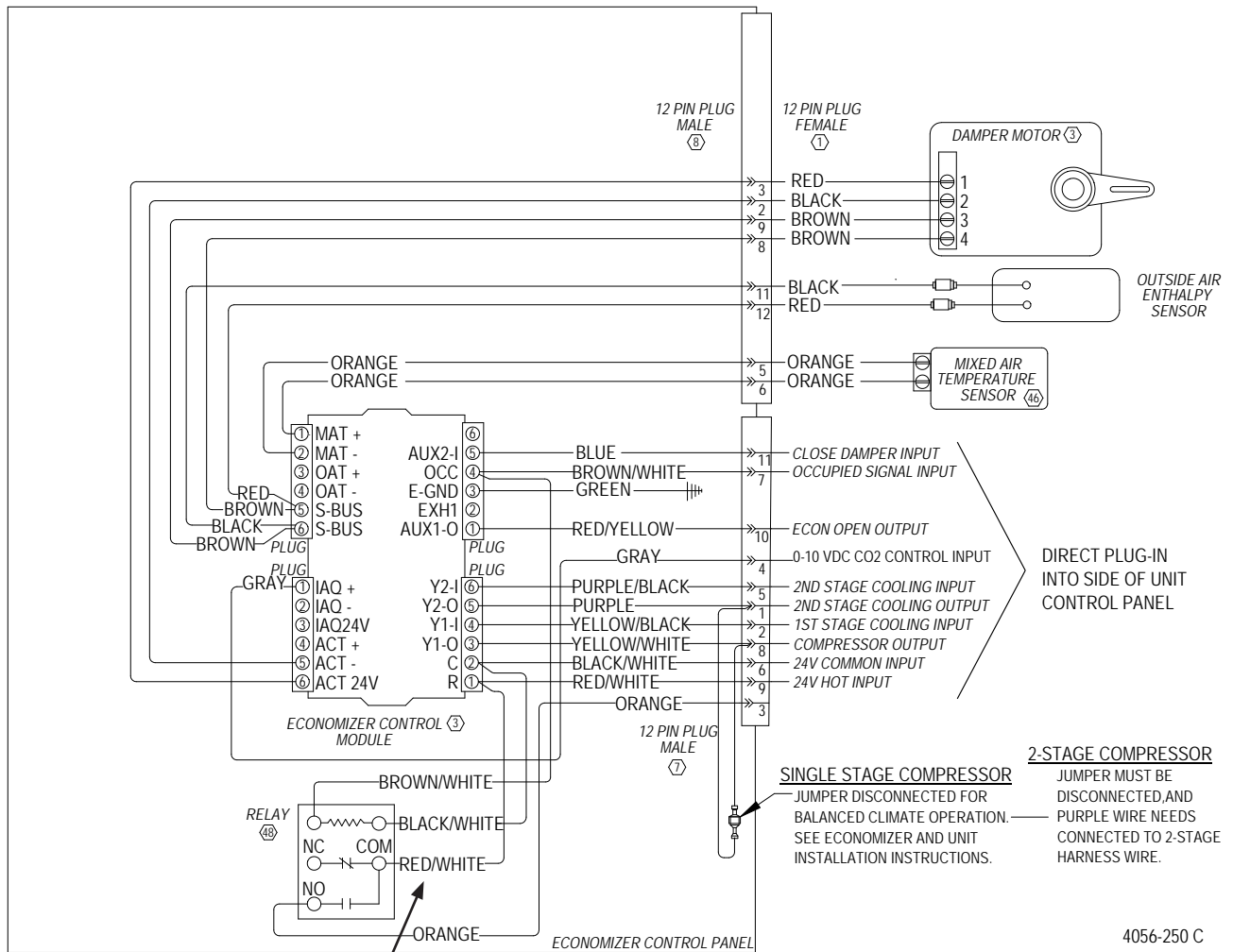

FIGURE 18
Wiring Diagram – Enthalpy Sensor



Move this RED/WHITE wire from COM to NC if jumper is used between A and G. See pages 12 or 13 for additional information.

NOTE: The Y1-Y2 jumper must be removed from the unit low voltage terminal strip in order for the vent to function. This jumper is already removed in units with factory-installed economizers.

4056-250 C