

---

# INSTALLATION AND OPERATION INSTRUCTIONS

---

## 8620-308 PGDx Touch Display for Stand-Alone MEGA-TEC<sup>®</sup> Unit *Part of the Bard Cooling System*

***NOTE: The PGDx touch display is to be used with a  
single MEGA-TEC unit.***



*Climate Control Solutions*

Bard Manufacturing Company, Inc.  
Bryan, Ohio 43506  
[www.bardhvac.com](http://www.bardhvac.com)

Manual: 2100-740B  
Supersedes: 2100-74A  
Date: 3-12-21

# CONTENTS

<b>General Information</b> .....	<b>3</b>
General.....	3
Shipping Damage .....	3
PGDx Touch Display and Available Accessories .....	3
<b>PGDx Installation</b> .....	<b>5</b>
Mounting the PGDx Enclosure.....	5
PGDx Connection to MEGA-TEC Unit.....	5
Power Wire Connections .....	6
Communication Wiring Connections.....	6
Powering On PGDx.....	7
PGDx Operation.....	8
<b>Using the PGDx Touch Display</b> .....	<b>9</b>
Main Screen.....	9
Login Screen.....	10
Time and Date Screen .....	10
Unit Status .....	11
Alarms Screen and History Alarms Screen .....	11
Dehumidification Setpoints Screen.....	13
Electric Reheat Dehumidification .....	14
Temperature Setpoints Screen .....	14
Comfort Mode Screen.....	15

## FIGURES

Figure 1	PGDx Enclosure Mounting.....	5
Figure 2	Remove Unit Control Access Panel.....	5
Figure 3	MEGA-TEC Power and Communication Terminals ...	5
Figure 4	Connecting PGDx to MEGA-TEC Unit .....	6
Figure 5	PGDx Main Screen .....	7
Figure 6	Communication Lost Message .....	7
Figure 7	Communications Lost Between PLC and PGDx .....	7
Figure 8	PGDx Not Enabled Message .....	8
Figure 9	Enable PGDx Selection Box.....	8
Figure 10	PGDx Touch Areas .....	9
Figure 11	Login Icon Locked.....	10
Figure 12	Login Screen .....	10
Figure 13	Password Screen Keyboard.....	10
Figure 14	Login Icon Unlocked.....	10
Figure 15	Date and Time Screen.....	11
Figure 16	Date and Time Screen Keyboard .....	11
Figure 17	Date and Time Displayed in Main Screen .....	11
Figure 18	Unit Status Displayed on Main Screen.....	11
Figure 19	Active Alarms Displayed on Main Screen .....	11
Figure 20	Resetting Active Alarms.....	12
Figure 21	Accessing History Alarms Screen .....	12
Figure 22	History Alarms Screen .....	12
Figure 23	Sorting Alarms in History Alarms Screen.....	12
Figure 24	Resetting Alarm History Log.....	12
Figure 25	Clearing Alarm History.....	12
Figure 26	Built-In Temperature/Humidity Sensor.....	13
Figure 27	Humidity Value Displayed on Main Screen .....	13
Figure 28	Dehumidification Setpoints Screen .....	13
Figure 29	Dehumidification Setpoints Screen of Unit Without Dehumidification Option .....	13
Figure 30	Adjusting Dehumidification Setpoint Values .....	13
Figure 31	Dehumidification Setpoints Screen of Unit With Electric Reheat Dehumidification Option .....	14
Figure 32	Enabling Dehumidification On Dehumidification Setpoints Screen .....	14
Figure 33	Temperature Value Displayed on Main Screen.....	14
Figure 34	Temperature Setpoints Screen .....	15
Figure 35	Adjusting Temperature Setpoint Values.....	15
Figure 36	Accessing Comfort Mode via Main Screen.....	15
Figure 37	Comfort Mode Screen .....	15

Information Screens.....	15
Information Screen 1: Indoor/Outdoor Temperature .....	15
Information Screen 2: Condenser Fan .....	16
Information Screen 3: AC Circuit 1 .....	16
Information Screen 4: AC Circuit 2 .....	17
Information Screen 5: Blower.....	17
Information Screen 6: Damper .....	17
Information Screen 7: General Information.....	17
Information Screen 8: Unit Information.....	18
Information Screen 9: Display Information .....	18
Configuration Menu Screen.....	18
Blower Options Screen .....	18
Continuous Blower .....	18
High Sensible Mode .....	19
Balanced Climate™ .....	19
Indoor Sensor Offsets Screen .....	19
Software Update Screen .....	19
Installing a Software Update .....	19
Emergency Cool Screen .....	22
Unit of Measure Screen .....	22
Password Screen.....	23

Figure 38	Main Screen Showing Unit Is in Comfort Mode.....	15
Figure 39	Accessing Information Screens via Main Screen ...	16
Figure 40	Scroll Bar on Information Screen .....	16
Figure 41	Using Information Screen Arrows and Home Button to Move to Other Screens .....	16
Figure 42	Information Screen 2: Condenser Fan .....	16
Figure 43	Information Screen 3: AC Circuit 1 .....	17
Figure 44	Information Screen 4: AC Circuit 2 .....	17
Figure 45	Information Screen 5: Blower .....	17
Figure 46	Information Screen 6: Damper.....	17
Figure 47	Information Screen 7: General Information .....	17
Figure 48	Information Screen 8: Unit Information.....	18
Figure 49	Information Screen 9: Display Information.....	18
Figure 50	Configuration Menu Icon on Main Screen.....	18
Figure 51	Configuration Menu .....	18
Figure 52	Continuous Blower .....	19
Figure 53	High Sensible Mode .....	19
Figure 54	Balanced Climate.....	19
Figure 55	Indoor Sensor Offsets Screen .....	19
Figure 56	Removed PGDx Front Bezel.....	20
Figure 57	Configuration Menu Icon on Main Screen.....	20
Figure 58	Software Update on Configuration Menu Screen ...	20
Figure 59	Software Update Instructions .....	20
Figure 60	Insert Micro USB Memory Stick.....	20
Figure 61	Update Button on Software Update Screen .....	20
Figure 62	Software Update Dialog Screen.....	21
Figure 63	Updating HMI Splash Screen .....	21
Figure 64	Update Completed .....	21
Figure 65	Update Progress Bar.....	21
Figure 66	Verifying Software Version Installed.....	21
Figure 67	Emergency Cooling on Configuration Menu Screen ..	22
Figure 68	Emergency Cool Screen .....	22
Figure 69	Unit of Measure on Configuration Main Screen.....	22
Figure 70	Unit of Measure Popup Screen .....	22
Figure 71	Password on Configuration Menu Screen.....	23
Figure 72	Password Screen .....	23

## TABLE

Table 1	PGDx Passwords (Defaults) .....	10
---------	---------------------------------	----

# GENERAL INFORMATION

## General

The PGDx display kit allows a single MEGA-TEC unit to run in stand-alone mode while providing a display of the unit. By connecting the PGDx display to the unit, status, operation and alarm display can be accessed from inside the climate-controlled area. The PGDx touch screen display is composed of a 4.3" 65K high quality colored touch display. The display connects using RS485 serial connection to Modbus PLAN connection. If more than one MEGA-TEC unit is installed, an LC6000 controller will need to be used to run the wall units.

The 8620-308 PGDx display kit includes the PGDx 4.3" touchscreen with built-in temperature/humidity sensors, enclosure, USB memory stick, two (2) EMI filters, instructions and 24VDC power supply. 4-wire 22 gauge shielded cable is recommended for connecting the PGDx to the MEGA-TEC unit but is not supplied with the kit.

**NOTE:** A PGD display (Bard P/N 8301-053) or TEC-EYE diagnostic tool (Bard P/N 8301-059) will be needed to commission the MEGA-TEC wall unit (see below). Neither are included with the 8620-308 PGDx display kit.

**IMPORTANT:** Disconnect the PGDx first before connecting a PGD or TEC-EYE. It is very important to

not have the PGDx and PGD plugged in at the same time. If this does happen, an I/O board fault on the PGD display may be received or the screen may appear scrambled. This does not fault the controller or the PGDx, but locks up the PGD display until back button on the PGD is pressed. The PGD will resume normal operation after being returned to the main screen.

The equipment covered in this manual is to be installed by factory trained and certified, experienced service and installation technicians.

These instructions should be carefully read before beginning the installation. Note particularly any tags and/or labels attached to the equipment.

While these instructions are intended as a general recommended guide, they do not supersede any national and/or local codes in any way. Authorities having jurisdiction should be consulted before the installation is made.

## Shipping Damage

Upon receipt of equipment, the cartons should be checked for external signs of shipping damage. If damage is found, the receiving party must contact the last carrier immediately, preferably in writing, requesting inspection by the carrier's agent.

## PGDx Touch Display and Accessories

### Included in 8620-308 Kit



**PGDx Touch Display**  
with built-in temperature  
and humidity sensors  
Bard P/N 8620-308



**USB Memory Stick**  
for software updates  
Bard P/N 8611-259



**EMI Filters**  
Bard P/N 8301-055

### IMPORTANT

Neither the TEC-EYE Tool or PGD Display are included with the 8620-308 kit but one or the other is required for the MEGA-TEC set-up process.

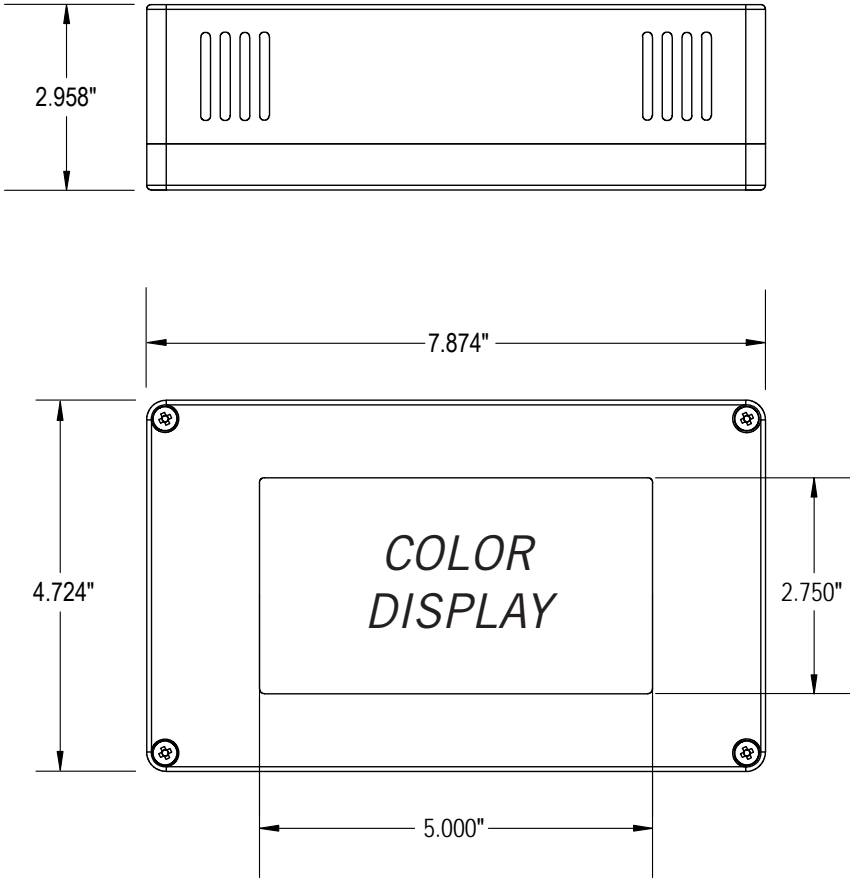


**TEC-EYE™ Hand-Held Diagnostic and Commissioning Tool**  
Bard P/N 8301-059



**PGD Display for diagnostics and commissioning**  
Bard P/N 8301-053

# PGDx Enclosure Dimensions



## **WARNING**

**Electrical shock hazard.**

**Disconnect VAC power supplies before servicing.**

**Failure to do so could result in electric shock or death.**

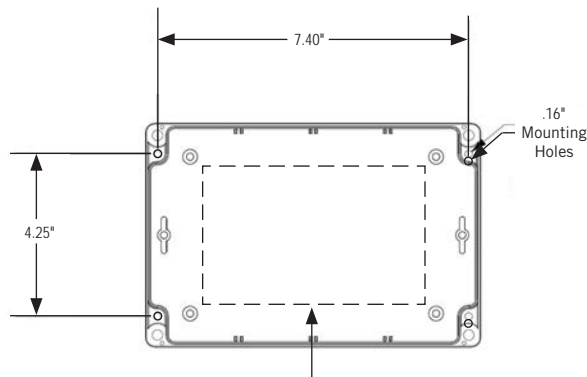
**IMPORTANT:** When working with circuit board components, Bard recommends the use of an anti-static wrist strap to prevent static electricity shorts to electronic controls.

### Mounting the PGD Enclosure

Four (4) mounting holes are provided for mounting the PGDx display to the wall. See Figure 1 for information on mounting. If the mounting holes are not sufficient, polycarbonate plastic box construction allows for easy hole drilling where needed. The PGDx display may also be installed on a 2 x 4 handi box to accommodate applications requiring wiring in a conduit.

Prior to mounting enclosure on wall, an opening will need to be made in the back of the enclosure for cabling (see Figure 1). The kit comes with a 24VAC to 24VDC power supply installed in the enclosure.

**FIGURE 1**  
PGDx Enclosure Mounting



Place access hole within dotted line. Polycarbonate plastic box construction allows for easy hole drilling where needed.

### PGDx Connection to MEGA-TEC Unit

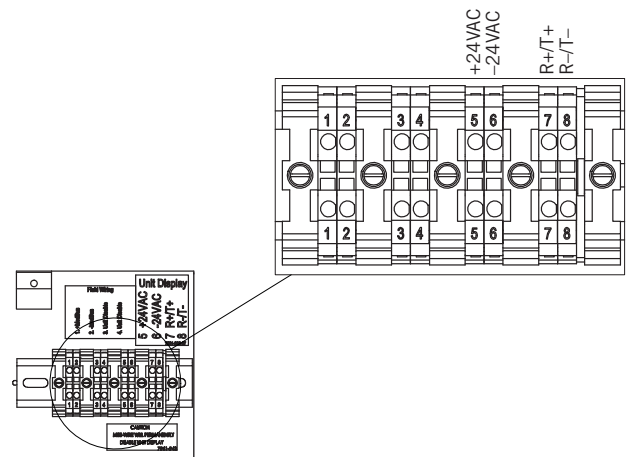
4-wire 22 gauge shielded cable is recommended for installation (200' max length). If non-shielded cable is used, maximum cable length is 6'. A 12" wire harness from the supplied 24VDC power supply to the PGDx is provided and wired to the power supply.

Remove the control access panel on the front of the MEGA-TEC unit to gain access to the connection terminals for 24VAC power and Modbus communications (see Figure 2). The power and communication terminals are located on the right side of a terminal block in the upper right-hand corner of the unit control panel (see Figure 3).

**FIGURE 2**  
Remove Unit Control Access Panel



**FIGURE 3**  
MEGA-TEC Power and Communication Terminals



If installing the PGDx in an area with high frequency electronic noise, Bard recommends using the supplied EMI filters (P/N 8301-055) when connecting power and communication wiring (see Figure 4 on page 6). Make a small service loop in the wiring and attach the EMI filter at the intersection of the loop as shown in Figure

4. At both the MEGA-TEC unit connection and the PGDx connection, include both the communication wiring and the power wiring in the filter.

**Power Wiring Connections**

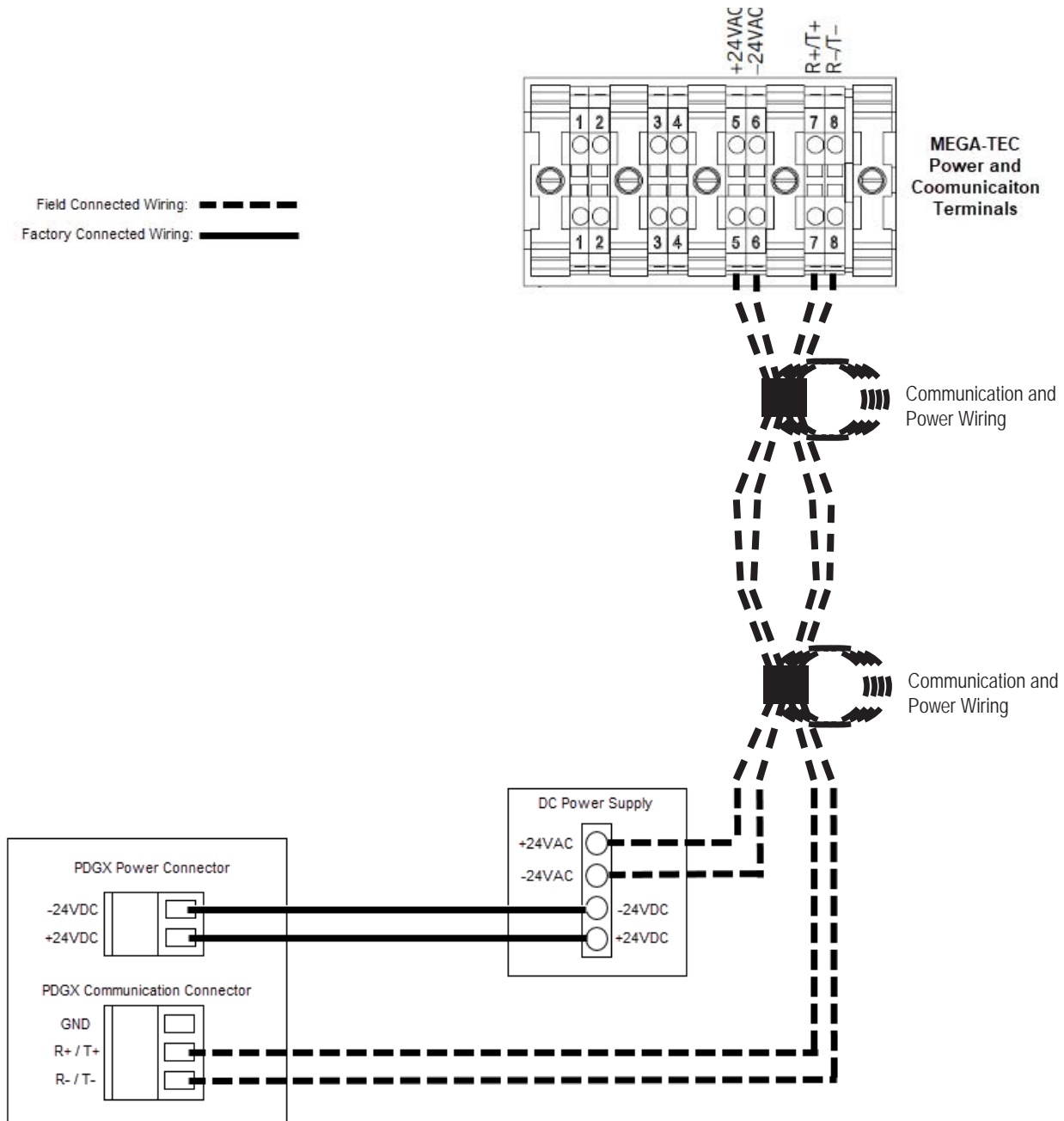
Connect two conductors to the 24VDC power supply installed in the PGDx enclosure as shown in Figure 4: One to the + 24 terminal and one to the – 24 terminal. Connect the other ends of the conductors to MEGA-TEC unit designated power terminals 5 and 6, matching the polarity to the + and – 24VAC PGDx power supply terminals.

**Communication Wiring Connections**

Connect two conductors to the PGDx communication connector as shown in Figure 4. Connect the other ends of these two conductors to MEGA-TEC unit designated communication terminals 7 and 8, matching the polarity to the PGDx communication connector connections.

After the wiring connections have been made, place the control access panel back on the MEGA-TEC unit.

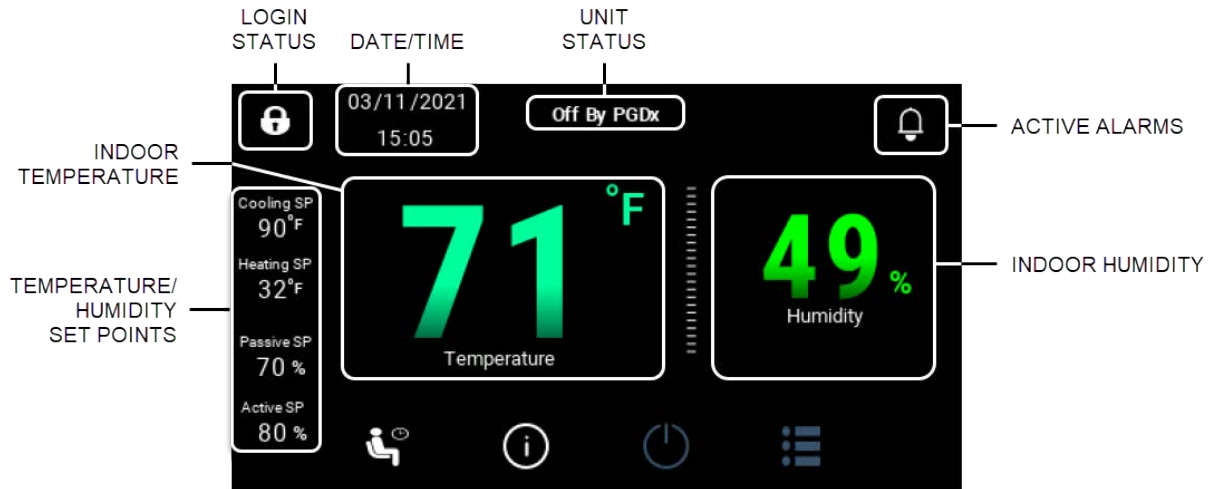
**FIGURE 4**  
Connecting PGDx to MEGA-TEC Unit



## Powering On PGDx

Once the power and communication wiring has been connected, power the unit main disconnect on. After the PLC controller program and the PGDX run-time load, the Main Screen will display (see Figure 5).

**FIGURE 5**  
PGDx Main Screen

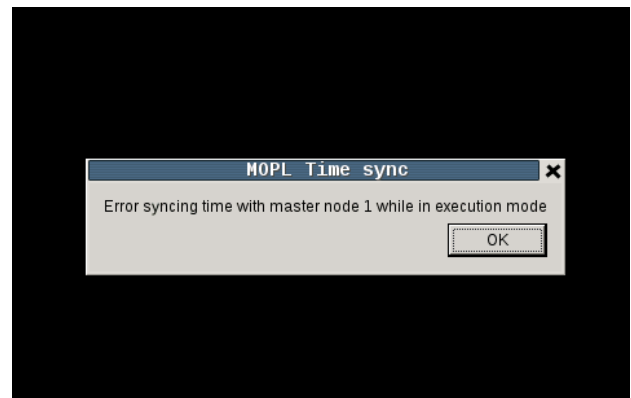


If communications are not established, a message will appear on the PGDx (see Figure 6). Make sure that all connections in Figure 4 are wired correctly as shown. If communications is not established within 10 minutes, another message will appear (see Figure 7). This is a operating systems level message indicating a communication loss between the unit PLC and PGDx. Once communications have been established, press OK to go to the Main Screen.

**FIGURE 6**  
Communications Lost Message

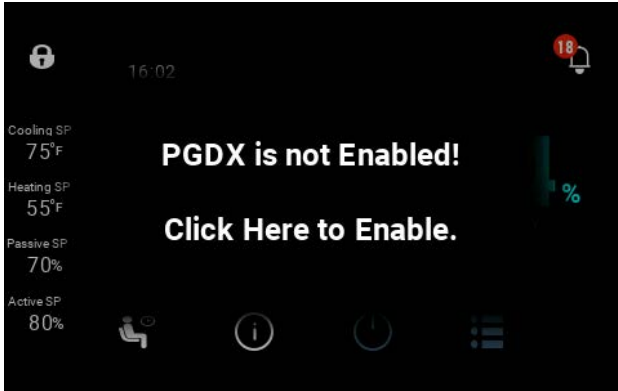


**FIGURE 7**  
Communications Lost Between PLC and PGDx



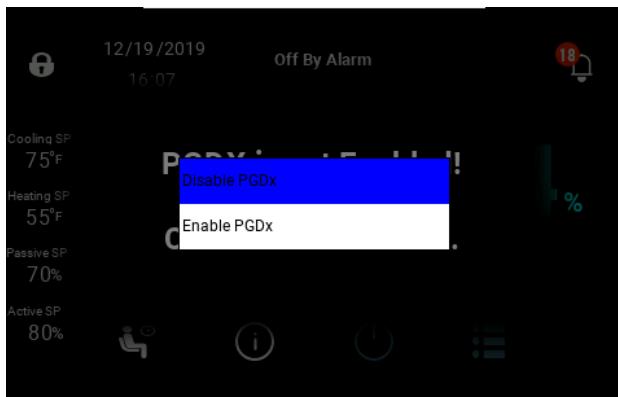
After communications are established with the wall unit and the PGDx enable bit is disabled, the message in Figure 8 on page 8 will appear.

**FIGURE 8**  
**PGDx Not Enabled Message**



To enable the PGDx, press as directed on the screen. From there, select Enable PGDx from the selection box (see Figure 9). The Main Screen will appear and the PGDx is ready to use.

**FIGURE 9**  
**Enable PGDx Selection Box**



## **PGDx Operation**

Once the unit is installed, the PGDx kit is connected (according to the supplied instructions) and the AC breakers are turned on, the MEGA-TEC unit is ready to run in standard heating and cooling mode (heating is optional).

Balanced Climate™ and dehumidification are available with the PGDx kit.

The features and sequence of operation available with the PGDx display kit include all functions and features available in stand-alone mode. Features and functions vary slightly by model and include:

- Emergency Cooling (economizer required)
- Alarm Logging
- Continuous Blower
- High Sensible Mode
- Balanced Climate
- Dehumidification

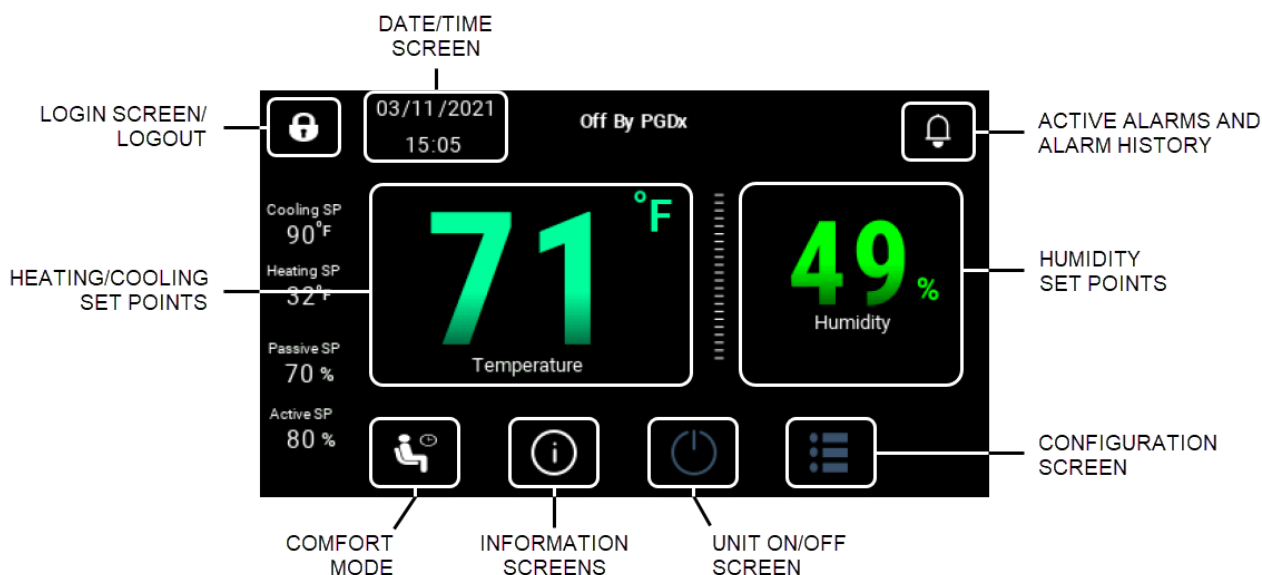


# USING THE PGD<sub>x</sub> TOUCH DISPLAY

## Main Screen

**FIGURE 10**  
PGD<sub>x</sub> Touch Areas

The screen icons listed below provide shortcuts to that screen for more options with the exception of Unit Status, Cooling Setpoint, Heating Setpoint, Passive Setpoint and Active Setpoint (located on the left side of the screen). Passive and Active Setpoint status are only available when dehumidification is enabled and the unit has dehumidification capabilities which is set in the model number.



### Login Screen/Logout

Goes to the login screen to insert user, service or manufacturing password. If unlocked, pressing this icon will go to the login screen to log out of the current user.

### Date and Time Screen

Goes to date and time screen where the date and time can be changed which will affect the wall unit PLC. (Requires login)

### Active and Alarm History

Goes to active alarms screen and also provides access to the alarm history screen.

### Heating and Cooling Setpoints

Goes to the heating and cooling setpoint screen where the unit heating and cooling setpoints can be adjusted. (Requires login)

### Humidity Screen

Goes to the dehumidification screen where off, passive and active setpoints can be enabled and set. (Requires login)

### Comfort Mode

Goes to comfort mode screen where comfort mode can be enabled, comfort mode duration can be set and comfort mode heating and cooling setpoints can be set.

### Information Screen

Goes to the information screen where unit information on temperatures, pressures, humidity and more is provided. There are a total of nine information screens; see **Information Screens** on page 15 for more detail on what is provided on each screen.

### Unit On/Off Screen

Goes to screen where unit can be turned on or off. (Requires login)

### Configuration Screen

Goes to configuration screen where access is provided to view and make adjustments to blower options, indoor sensor offsets, software updates, emergency cooling, unit of measure and passwords. (Requires login)

## Login Screen

When the PGDx is powered on for the first time, a password will need to be entered in order to gain access to any of the screens from the Main Screen. To do this, either press on the padlock icon (see Figure 11) or on the desired icon on the screen. All the icons on the Main Screen provide a shortcut to a different screen except the heating, cooling, passive and active setpoints and the unit status display. Those are only for reference and do not enable a shortcut.

**FIGURE 11**  
Login Icon Locked



Unless previously unlocked, when a shortcut icon on the Main Screen is touched, the Login Screen will come up (see Figure 12). Touch in the oval to bring up the input keyboard to enter the password (Figure 13). The list of available passwords are shown in Table 1. Type in the 4 digit password and the Main Screen will show the padlock as unlocked as shown in Figure 14 or, if an icon other than the padlock was touched, the short cut will go to that specific screen.

Notice in Figure 14 that the Unit On/Off and Configuration Menus are no longer grayed out.

**FIGURE 12**  
Login Screen



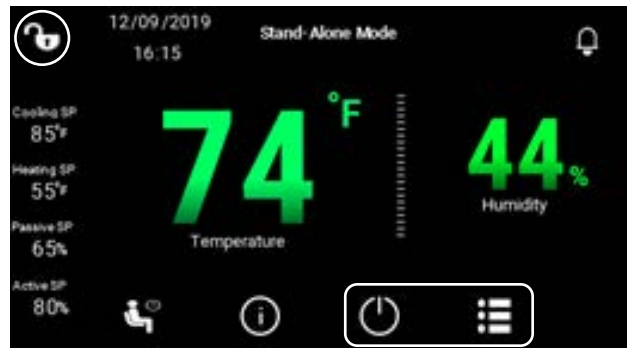
**FIGURE 13**  
Password Screen Keyboard



**TABLE 1**  
PGDx Passwords (Defaults)

User	2000
Technician	1313
Engineer	9254

**FIGURE 14**  
Login Icon Unlocked



To log out, return to the Main Screen from any screen by touching the house icon at the top left corner of the screen. When on the Main Screen, touch the padlock at the top left corner. Touch the logout button at the bottom right corner as shown in Figure 12. This returns to the Main Screen and indicates the password is locked (padlock icon locked) as shown in Figure 11. Display will also lock out after 8 minutes of no activity.

## Date and Time Screen

The current date and time for the local time zone can be set using the Date and Time Screen (see Figure 15). When the date and time is set on the PGDx, it is also set on the unit controller as well.

To change the time and date, press on the appropriate number of the date or time to get the number keyboard to pop up. For example, press on the year and a keyboard will pop up as shown in Figure 16. After changing the time and/or date, press the SAVE

**FIGURE 15**  
Date and Time Screen



**FIGURE 16**  
Date and Time Screen Keyboard



checkmark in the lower right corner (Figure 15) to save the date and time.

To verify that the date and time changed correctly, press the house icon on the top left of the Date and Time Screen to return to the Main Screen. **IMPORTANT: Wait 5 seconds before returning to the Main Screen. Failure to wait will prevent the changes from being made.** The date and time are displayed in the top left of the Main Screen. Confirm that the date and time changes made are reflected there (Figure 17).

**FIGURE 17**  
Date and Time Displayed on Main Screen



## Unit Status

The unit status displayed on the Main Screen allows the user to see what the current status of the unit is (see Figure 18). The PGDx status messages are the same as those on the PGD/TEC-EYE display. This is just a display and is not a shortcut to another screen.

**FIGURE 18**  
Unit Status Displayed on Main Screen



## Alarms Screen and History Alarms Screen

The Alarms Screen and History Alarms Screen give the user a list of current active alarms along with a history log of the active alarms.

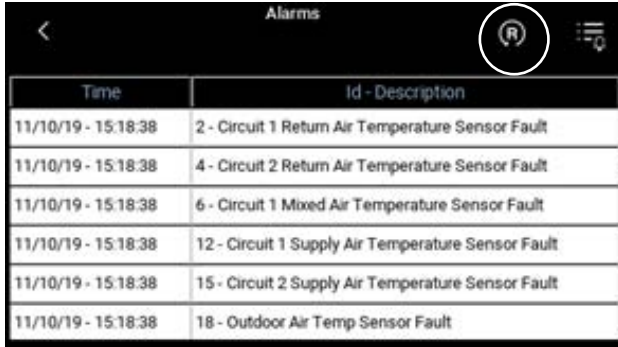
To see if there are active alarms, look at the bell icon on in the top right corner of the Main Screen (see Figure 19). If there are active alarms, the bell will have a red circle to the left of it with a number representing the number of active alarms. Press on the bell icon to go to the Alarms Screen.

**FIGURE 19**  
Active Alarms Displayed on Main Screen



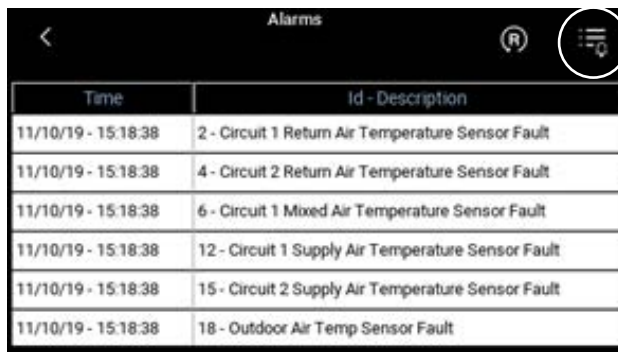
The Alarms Screen shows a list of active alarms; these alarms will automatically reset once they are addressed. The active alarms can be reset by pressing the reset button on the Alarms Screen (see Figure 20 on page 12). Not all active alarms can be cleared by simply pressing the reset button; certain alarms may require additional action in order to reset.

**FIGURE 20**  
Resetting Active Alarms

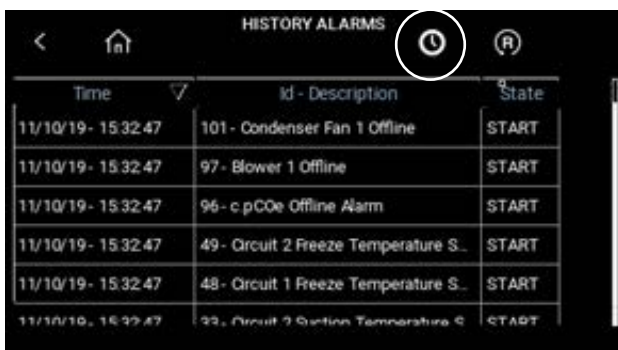


The History Alarms Screen can be accessed by pressing the icon at the top right of the Alarms Screen (see Figure 21). This screen displays a log of the active alarms. The History Alarms Screen shows the alarm date, time, ID, description and state (see Figure 22). The alarms stay in the alarm log until the alarm buffer is full or the alarm log is reset.

**FIGURE 21**  
Accessing History Alarms Screen

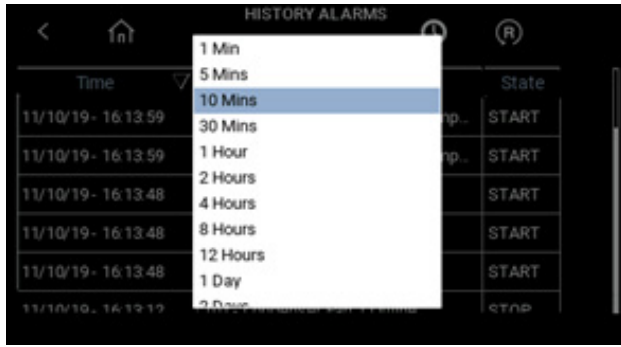


**FIGURE 22**  
History Alarms Screen



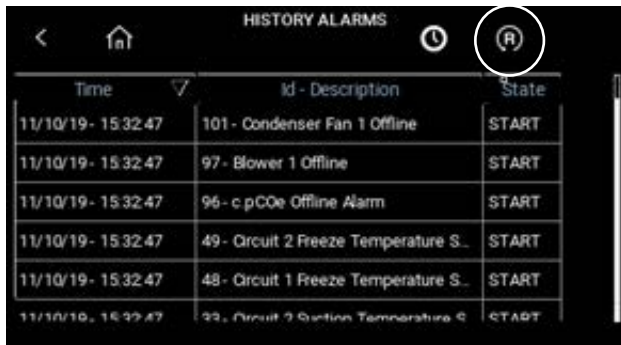
The alarm history log can be sorted by selecting the clock icon on the top right of the History Alarms Screen (see Figure 22). This will bring a dialogue box down where choices of minutes, hours, days and weeks can be used to sort the alarms (see Figure 23). Scroll to the bottom of this dialogue box for more options.

**FIGURE 23**  
Sorting Alarms in History Alarms Screen

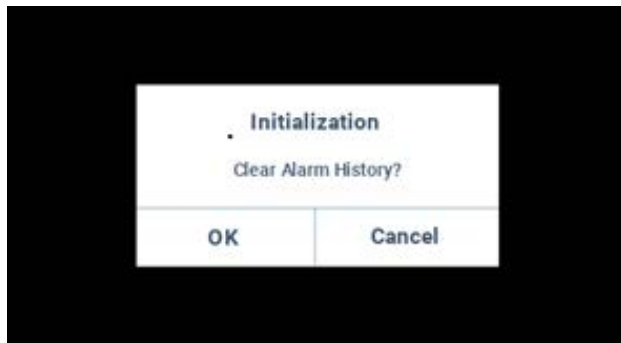


The alarms shown on the History Alarms Screen log can be reset by pressing the reset button on the top right (see Figure 24). When deleting the alarm history log on the PGDx, it will also delete the alarm history on the PGD. However, resetting the alarm history on the PGD, will not clear the alarm history log on the PGDx. After the reset button is pressed, an initialization dialogue box will appear (see Figure 25). Press OK to clear history alarms.

**FIGURE 24**  
Resetting Alarm History Log



**FIGURE 25**  
Clearing Alarm History



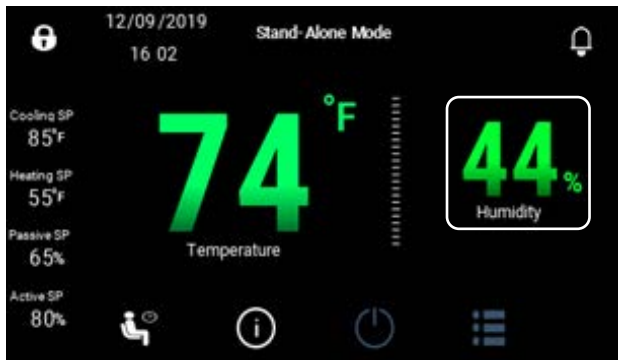
## Dehumidification Setpoints Screen

The PGDx is equipped with a built-in temperature/humidity sensor, which helps monitor room temperature and humidity in the room where the touch screen is installed (see Figure 26). The humidity value is displayed on the Main Screen as shown in Figure 27.

**FIGURE 26**  
Built-In Temperature/Humidity Sensor

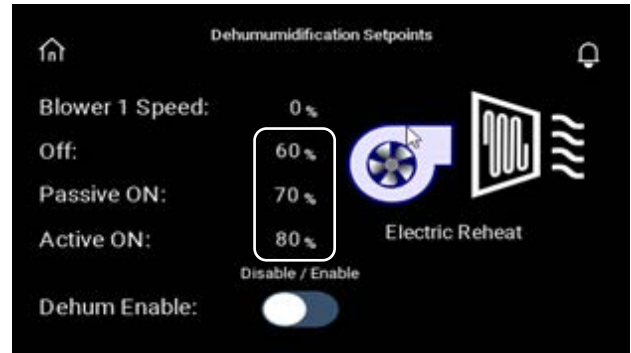


**FIGURE 27**  
Humidity Value Displayed on Main Screen

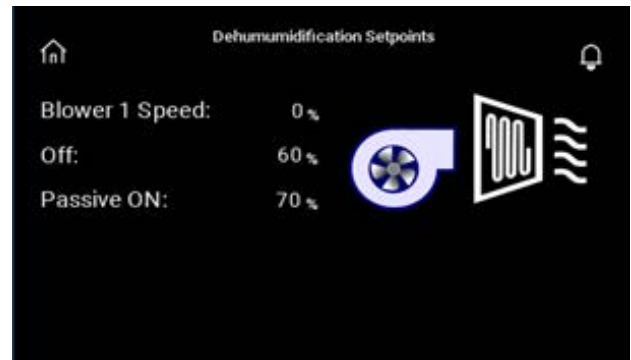


Press on the humidity value to go to the Dehumidification Setpoints Screen (see Figure 28). If not already logged in, the Login Screen will come up and the password will need to be entered in order to get to the Dehumidification Setpoints Screen. This screen shows the dehumidification setpoint values along with the blower speed value. When there is no dehumidification option installed or the wrong unit model number has been input, all options may not be displayed on the screen (Figure 29).

**FIGURE 28**  
Dehumidification Setpoints Screen

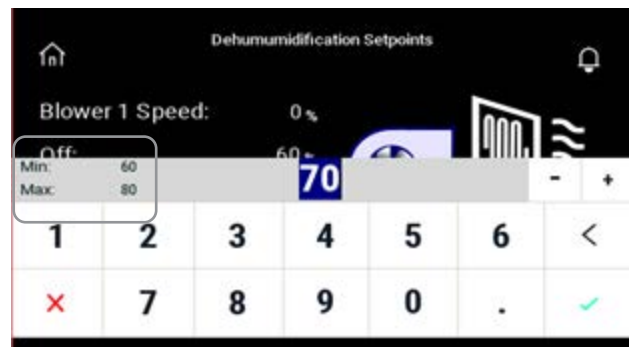


**FIGURE 29**  
Dehumidification Setpoints Screen of Unit Without Dehumidification Option



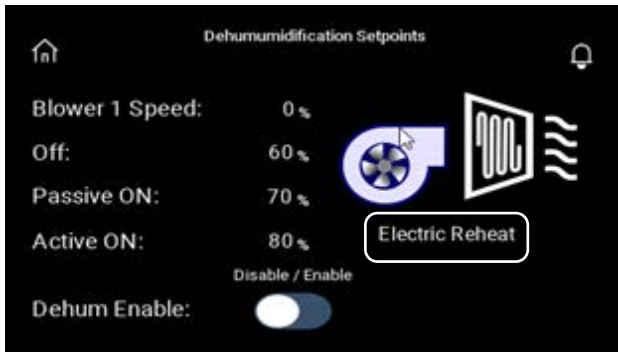
The Dehumidification Setpoints Screen allows the dehumidification Off, Passive On, and Active On setpoints to be adjusted for humidity control. To adjust these settings, press on the desired setting value and this will bring up a keyboard to use to make adjustments (see Figure 30). When entering the setpoint value, notice the Min: and Max: setpoint values in the upper left of the keyboard as shown in Figure 30.

**FIGURE 30**  
Adjusting Dehumidification Setpoint Values



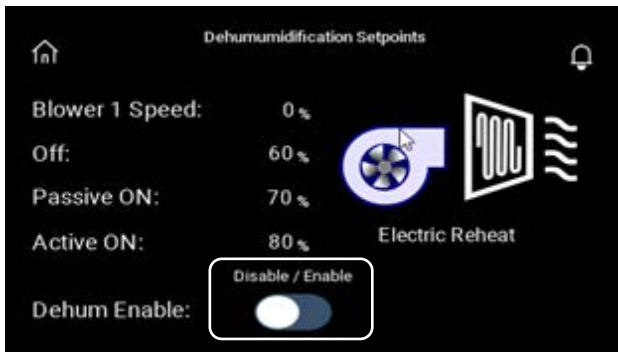
Dehumidification is an option and when the unit is installed, the model number will indicate what options are installed in the unit. For the example used in illustration below, this unit is equipped with electric reheat dehumidification as shown in Figure 31. This indicates what dehumidification type the unit is equipped with.

**FIGURE 31**  
**Dehumidification Setpoints Screen of Unit with Electric Reheat Dehumidification Option**



First, enable dehumidification by toggling Dehum Enable toggle at the bottom of (see Figure 32). Enabling the dehumidification allows the setpoints to be adjusted for the particular application needs. Once dehumidification is enabled, the blower will modulate based on dehumidification demand. The PGDx uses the built-in humidity sensor to determine points of action during dehumidification operation.

**FIGURE 32**  
**Enabling Dehumidification on the Dehumidification Setpoints Screen**



**Electric Reheat Dehumidification**

There are two dehumidification setpoints available to the user: passive and active. During the passive dehumidification sequence, the unit economizer (if equipped) will be disabled and blower speeds may be optimized to have more latent capacity. When the wall unit receives an active dehumidification call, the wall unit will enter active dehumidification mode. The dehumidification sequence will run until the space

temperature falls to the heating setpoint, increases to the cooling setpoint or the humidity setpoint is reached. Upon receiving an active dehumidification call, the wall unit will energize to compressor and the electric reheat coil will be energized to extend the run time of the cooling cycle while mitigating the cooling done by the compressor. If/when the temperature falls to 2° above heating setpoint, the compressor will be disabled until the temperature is increased to 2° below the cooling setpoint and then the compressor will be re-energized. If/when the temperature reaches 4° below the cooling setpoint, the electric heating elements will be energized. The electric heating elements will be disabled 2° below the cooling setpoint. The system will continue the dehumidification process until either the heating or cooling setpoint are reached again or the requirement for dehumidification is no longer present.

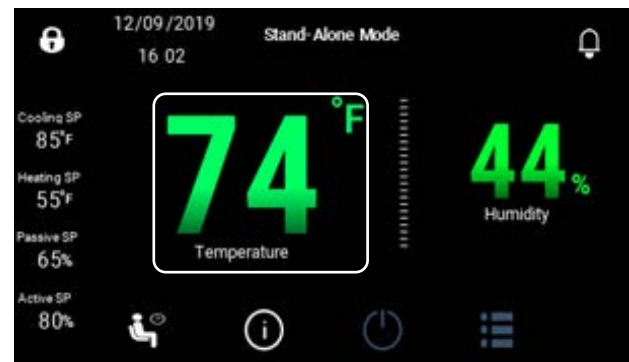
The built-in temperature/humidity sensor value will be used to determine points of action during dehumidification operation.

**Temperature Setpoints Screen**

The Temperature Setpoints Screen allows the wall unit heating and cooling setpoints to be adjusted.

To access the Temperature Setpoints Screen, press on the temperature value on the Main Screen (Figure 33). This number is the value of the temperature sensor that is built into the PGDx touchscreen.

**FIGURE 33**  
**Temperature Value Displayed on Main Screen**



The Temperature Setpoints Screen shows the cooling and heating setpoint values (see Figure 34). To adjust these settings, press on the desired setting value and this will bring up a keyboard to use to make adjustments (see Figure 35). Enter the setpoint value that is between the Min: and Max: values shown in the top upper left corner of the keyboard and press the ENTER key.

If at any time the wall unit loses communication with the PGDx, the unit will go into orphan mode and operate using the last communicated setpoints.

**FIGURE 34**  
Temperature Setpoints Screen



**FIGURE 35**  
Adjusting Temperature Setpoint Values



### Comfort Mode Screen

The Comfort Mode Screen can be accessed from a shortcut on the Main Screen. Press on the Comfort Mode button on the bottom left of the screen (see Figure 36). No login is required to access the Comfort Mode Screen.

**FIGURE 36**  
Accessing Comfort Mode via Main Screen

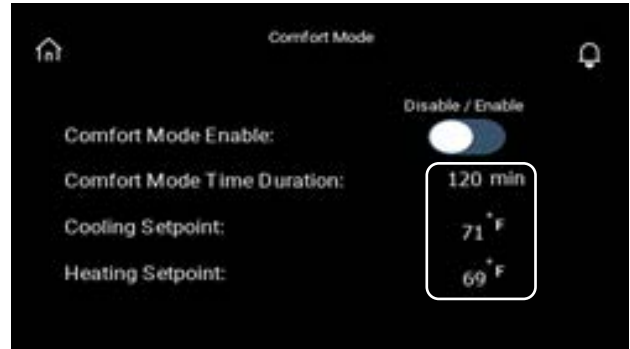


Once on the Comfort Mode Screen, enable comfort mode by toggling the disable/enable button (see Figure 37). Once comfort mode has been enabled, the time duration for how long the mode will maintain the cooling and heating setpoints can be set. Adjust the time duration and heating and cooling setpoint by pressing on the value. This will bring up a keyboard

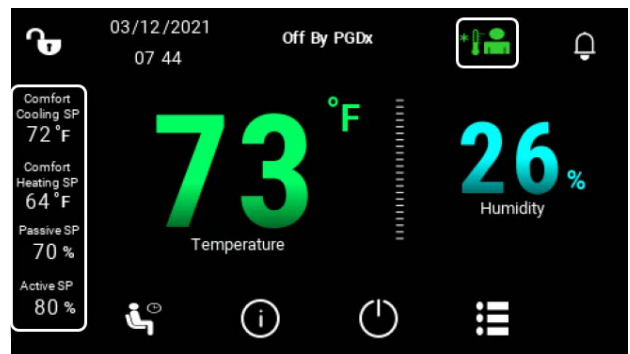
to be used to enter values. Comfort mode setpoints override the wall unit temperature setpoints while comfort mode is enabled (Figure 37). If comfort mode is activated, it will run in cooling for the user-selected time if it is above 71° and heat if it goes below 69°. The setpoints have a 2° separation between them.

On the Main Screen there is an indicator that shows when the unit is in comfort mode and the cooling and heating setpoints will change to reflect the active comfort mode cooling and heating setpoints (Figure 38).

**FIGURE 37**  
Comfort Mode Screen



**FIGURE 38**  
Main Screen Showing Unit is in Comfort Mode



### Information Screens

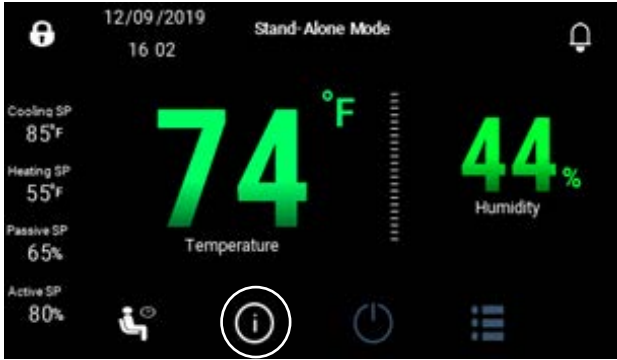
Press the information icon on the Main Screen (see Figure 39 on page 16) to access information screens that display temperatures, pressures in the AC circuits, fan, blower and important I/O information. No login is required to access the information screens.

#### Information Screen 1: Indoor/Outdoor Temperature

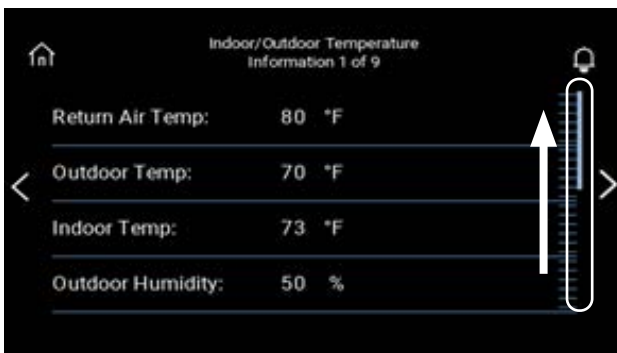
Pressing the information screen icon on the Main Screen brings up the first of nine information screens (see Figure 40 on page 16). The first information screen shows the following:

1. Return Air Temp
2. Outdoor Temp
3. Indoor Temp (PGDx Sensor)
4. Outdoor Humidity
5. Indoor Humidity (PGDx Sensor)

**FIGURE 39**  
**Accessing Information Screens via Main Screen**



**FIGURE 40**  
**Scroll Bar on Information Screen**

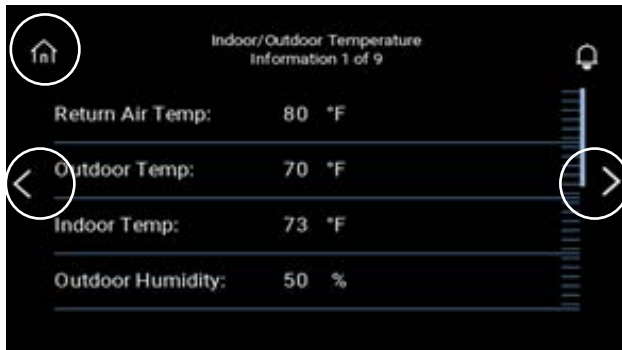


Certain information screens have more information than what can fit on the screen at one time. In Figure 40, the scroll bar is highlighted which indicates there is more information at the bottom of the screen. To get to this information, press on the screen and swipe up until the information is shown.

To move to another information screen, press one of the arrows located on the right or left edges of the screen (see Figure 41). Press the right arrow to go to the next screen in the sequence or press the left arrow to go to the last screen in the sequence (screen 9 of 9). This is a continuous loop. Press the house icon on the top left of the screen to leave the information screens and return to the Main Screen.

The information provided in the information screens are informational and the values are not able to be changed with the exception of the brightness on display information screen 9 of 9.

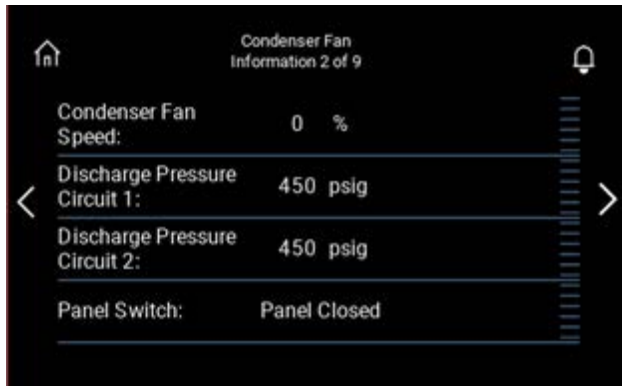
**FIGURE 41**  
**Using Information Screen Arrows and Home Button to Move to Other Screens**



**Information Screen 2: Condenser Fan**

The MEGA-TEC is equipped with two refrigeration circuits. The condenser fan information screen displays fan speed percentage along with discharge pressures for both refrigeration circuits (see Figure 42). For more information on the two refrigeration circuits in MEGA-TEC units, see the latest revision of MEGA-TEC service instructions manual 2100-671.

**FIGURE 42**  
**Information Screen 2: Condenser Fan**



**Information Screen 3: AC Circuit 1**

The AC circuit 1 information screen displays information on high pressure status, suction pressure, liquid temperature, evaporator temperature, EEV position and compressor state status (see Figure 43).

**NOTE:** When the 6th character of the unit model number is set to N (400V), "Compressor 1 Full" will not be displayed. When the unit is set to 400V, there are only two single stage compressors.



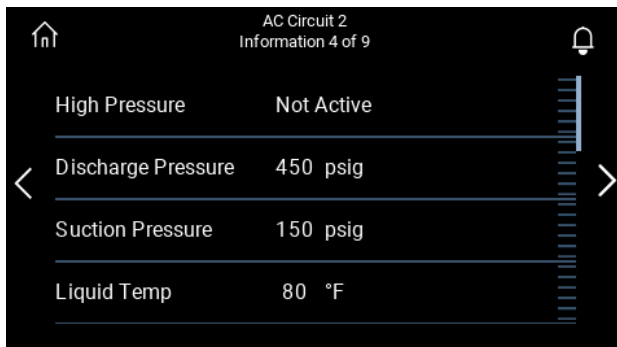
**FIGURE 43**  
**Information Screen 3: AC Circuit 1**



**Information Screen 4: AC Circuit 2**

The AC circuit 2 information screen has the same information as AC circuit 1 (see Figure 44). This screen displays information on compressor 2 status.

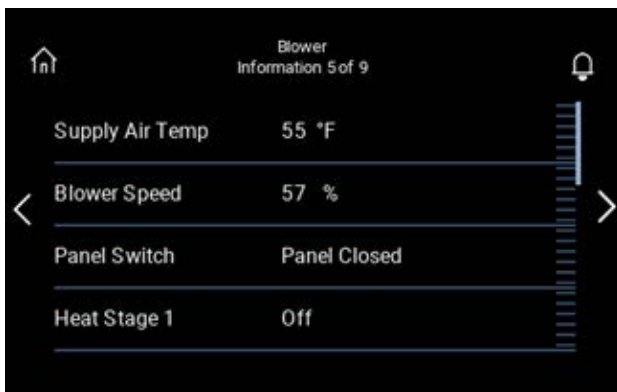
**FIGURE 44**  
**Information Screen 4: AC Circuit 2**



**Information Screen 5: Blower**

The blower information screen displays supply air temperature, blower speed percentage, heating stages, air flow switch, filter switch and filter indicator (see Figure 45).

**FIGURE 45**  
**Information Screen 5: Blower**

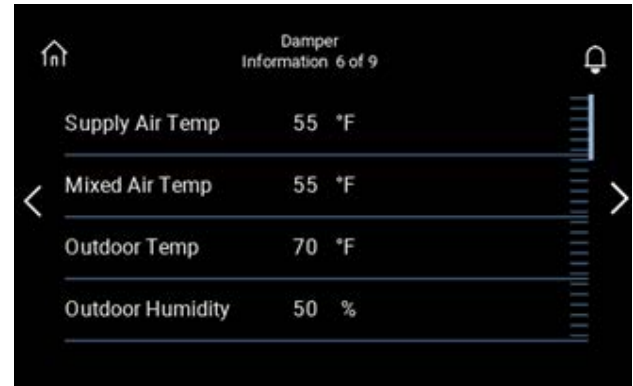


**Information Screen 6: Damper**

The damper information screen displays supply air temp, mixed air temp, outdoor temp, outdoor humidity, damper position, dust sensor and damper open/closed state (see Figure 46).

**NOTE:** When the 10th character of the unit model number is set to B (economizer setting), "Mixed Air Temp" will not be available.

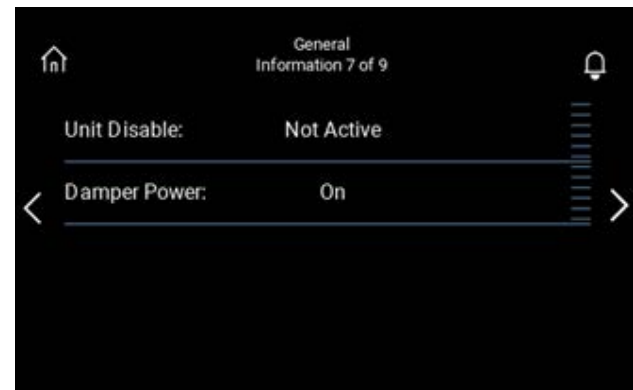
**FIGURE 46**  
**Information Screen 6: Damper**



**Information Screen 7: General Information**

The general information screen displays unit disable and damper power status (see Figure 47).

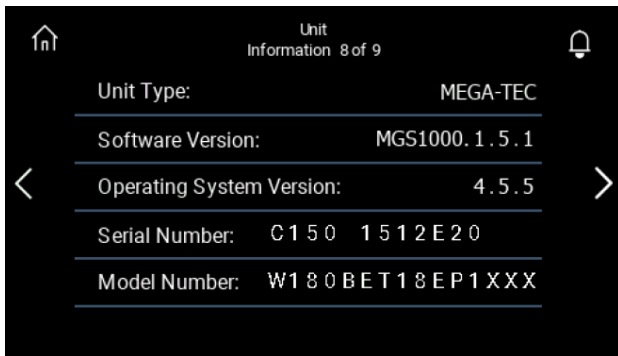
**FIGURE 47**  
**Information Screen 7: General Information**



### Information Screen 8: Unit Information

The unit information screen displays unit type, software version, operating system version, serial number and model number (see Figure 48). The unit type is the name of the wall unit. The software version is the version of the software running on the controller. Operating system version is the version of the operating system running on the controller. The model and serial numbers are read from the controller and reflect the model and serial number of the wall unit entered when setting up the unit with the PGD or TEC-EYE.

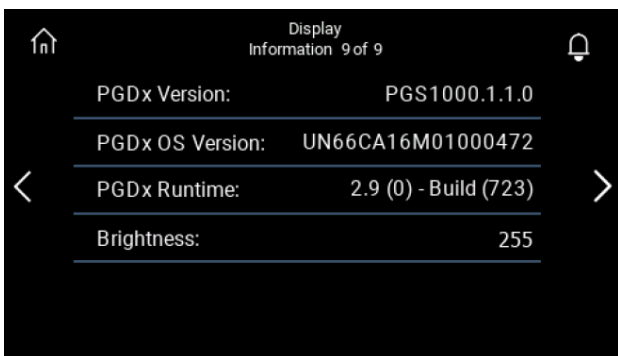
**FIGURE 48**  
Information Screen 8: Unit Information



### Information Screen 9: Display Information

The display information screen displays the PGDx software version, main operating system version, software runtime and brightness (see Figure 49). The software version of the PGDx display is shown. The main OS is the operating system version number running the display. Software runtime is the development software version number that is used to develop the screen for the PGDx touch display. Brightness changes the brightness of the display and it can be set between 0-255 (255 being the brightest). To change the brightness, press on the number value and enter the desired brightness level.

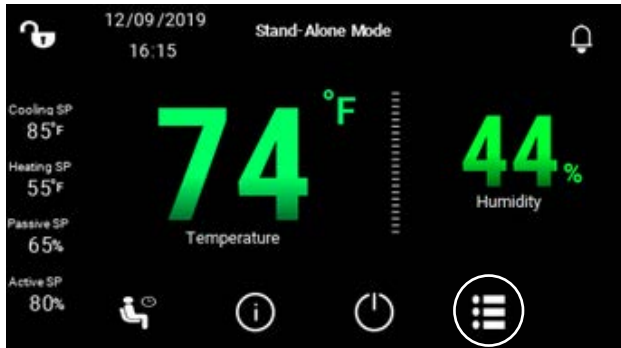
**FIGURE 49**  
Information Screen 9: Display Information



### Configuration Menu Screen

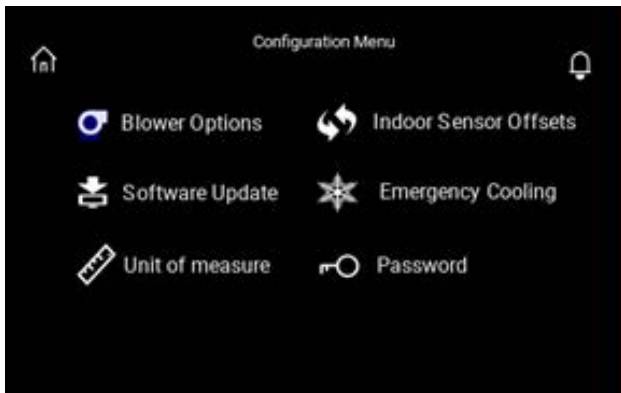
To access the configuration menu, either log in (if not already logged in) using the Login Screen (see page 9) or press the configuration menu icon on the Main Screen (see Figure 50). Either way will bring up the Password Screen.

**FIGURE 50**  
Configuration Menu Icon on Main Screen



The Configuration Menu Screen provides access to the blower options, indoor sensor offsets, software update, emergency cooling, unit of measure and password screens (see Figure 51).

**FIGURE 51**  
Configuration Menu Screen



### Blower Options Screen

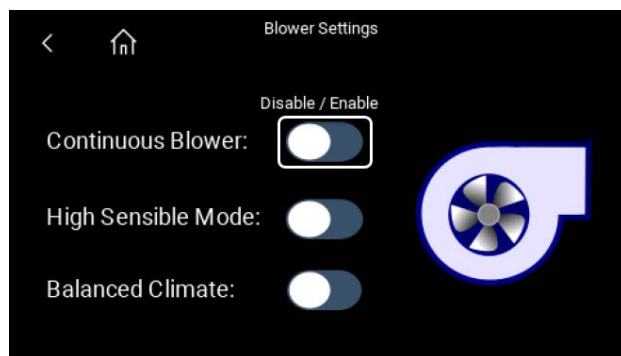
The Blower Options Screen provides access to three different modes of blower operation as well as blower speed. For more information on MEGA-TEC blower operation and alarms, see the latest revision of MEGA-TEC service instructions manual 2100-671.

#### **Continuous Blower**

The first option listed is continuous blower. When continuous blower is enabled (see Figure 52), the wall unit will run in continuous blower mode when connected to a stand-alone controller. This option will run the blower all the time. The continuous blower option is defaulted to off.

The wall unit will always operate in continuous blower when not connected to a stand-alone controller (orphan mode).

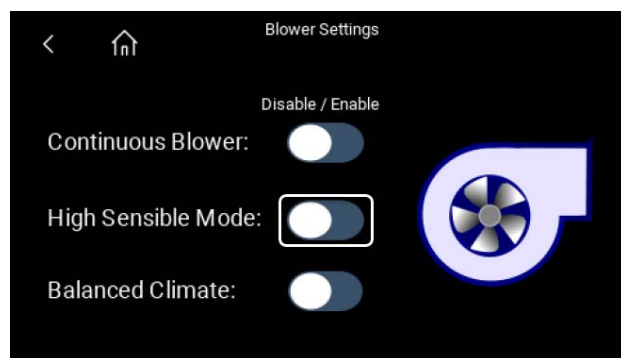
**FIGURE 52**  
**Continuous Blower**



### High Sensible Mode

With the high sensible option enabled, the wall unit will increase blower speed to enhance the sensible cooling capacity of the unit (see Figure 53). This option is not enabled by default.

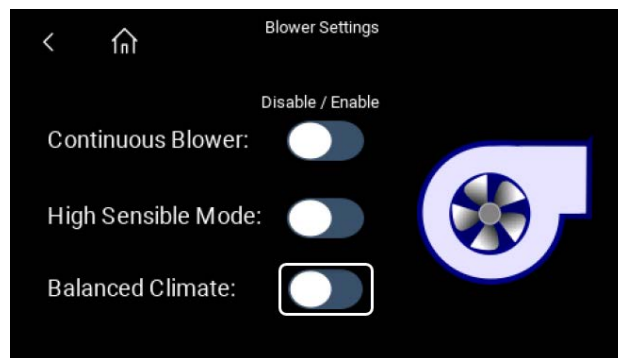
**FIGURE 53**  
**High Sensible Mode**



### Balanced Climate™

With Balanced Climate mode enabled, the wall unit will enhance the comfort level by reducing the indoor airflow amount and extending the run time to help extract more humidity during cooling operation (see Figure 54). This option is not enabled by default.

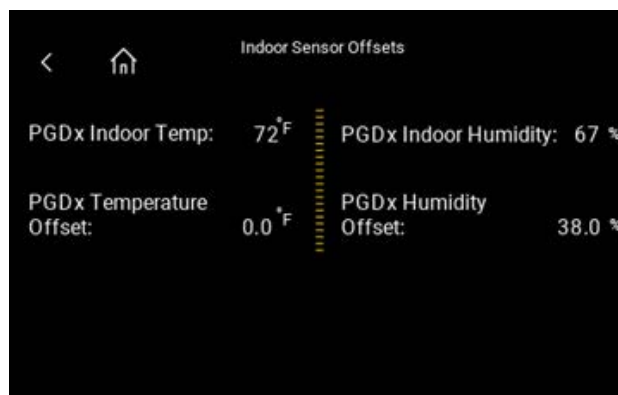
**FIGURE 54**  
**Balanced Climate**



### Indoor Sensor Offsets Screen

The Indoor Sensor Offsets Screen allows the user to offset the temperature and humidity of the PGDx on-board sensors (see Figure 55). This can be useful for troubleshooting unit issues. The raw temperature and humidity values are shown above the offsets. To change an offset, press on the offset value displayed.

**FIGURE 55**  
**Indoor Sensor Offsets Screen**



### Software Update Screen

When Bard releases a software update, this option is used to install the update via a USB A to micro USB memory stick. A USB memory stick (Bard P/N 8611-259) to use in this process is provided with the PGDx 8620-308 kit.

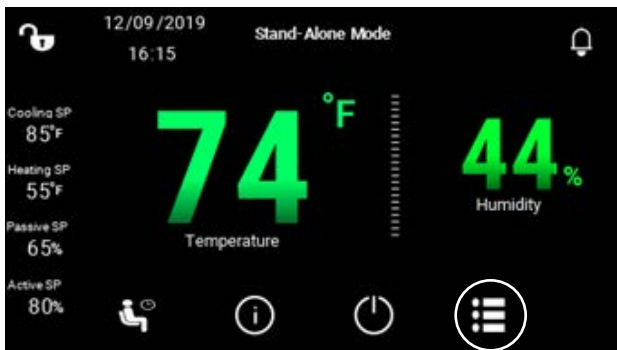
#### Installing a Software Update

1. Download the update zip file to the USB memory stick from [www.bardhvac.com/software-download/](http://www.bardhvac.com/software-download/).
2. Remove the front bezel from the PGDx (see Figure 56 on page 20).
3. Press the configuration menu icon at the bottom of the screen (see Figure 57 on page 20). If not logged already in, there will be a prompt to log in before allowing access to the Configuration Menu Screen.

**FIGURE 56**  
Remove PGDx Front Bezel

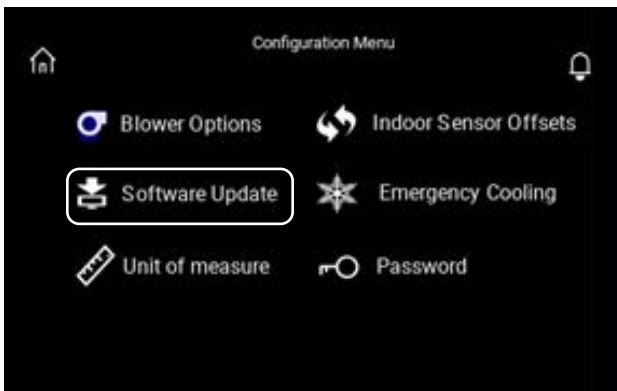


**FIGURE 57**  
Configuration Menu Icon on Main Screen



4. Select Software Update on the Configuration Menu Screen (see Figure 58).

**FIGURE 58**  
Software Update on Configuration Menu Screen



5. The next screen explains how to do the update procedure (see Figure 59).

**FIGURE 59**  
Software Update Instructions



6. Insert the micro USB side of the memory stick into the front of the PGDx as shown in Figure 60. After the memory stick has been inserted, press the update button which should appear on the screen along with a green USB indicator (see Figure 61).

**FIGURE 60**  
Insert Micro USB Memory Stick



**FIGURE 61**  
Update Button on Software Update Screen



If the memory stick is empty or the wrong file is copied, a dialogue screen will appear (see Figure 62). If this happens, confirm the correct file was downloaded to the memory card: UpdatePackage.

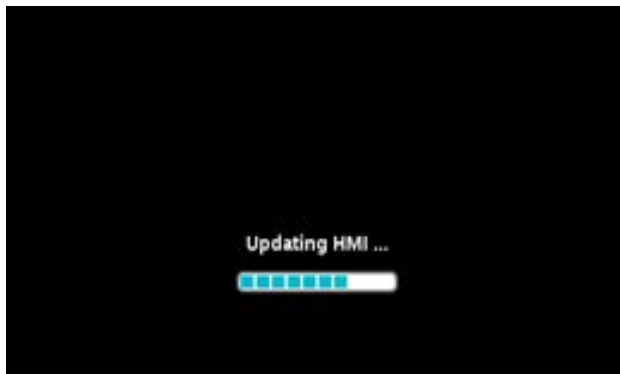
zip is the file that the PGDx looks for when doing the update. This dialogue box will also appear if there are no files on the memory stick at all. Press Cancel to clear this screen.

**FIGURE 62**  
Software Update Dialog Screen



After the correct file has been placed on the memory stick, re-insert the memory stick and press the update button again. If the correct file is on the memory stick, the screen will show the “Updating HMI...” splash screen (See Figure 63).

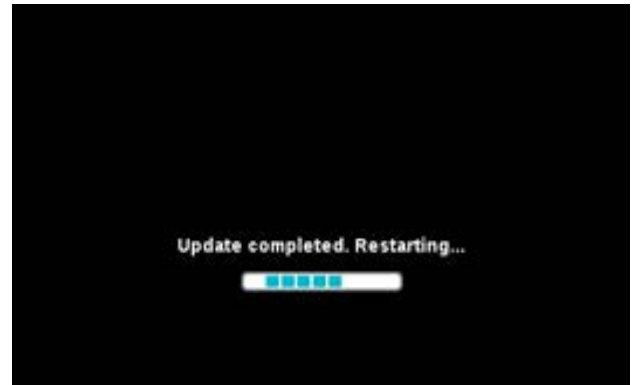
**FIGURE 63**  
Updating HMI Splash Screen



7. After the update has finished, the PGDx will restart (see Figure 64) and a progress bar will be displayed, indicating the PGDx software is restarting (see Figure 65).
8. Once the PGDx software has loaded, the Main Screen will come up. Verify that the correct runtime software version is installed. To do this, go to the Information Screen (see page 15) and press on the left arrow, which goes to the Display Information 9 of 9 Screen. Software Version is displayed at the top (see Figure 66). The software version should match the software version that is posted on Bard’s website under software download: [www.bardhvac.com/software-download/](http://www.bardhvac.com/software-download/).

9. This completes the software update process.

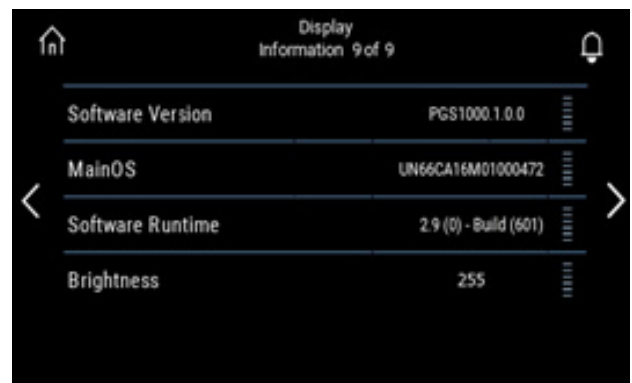
**FIGURE 64**  
Update Completed



**FIGURE 65**  
Update Progress Bar



**FIGURE 66**  
Verifying Software Version Installed

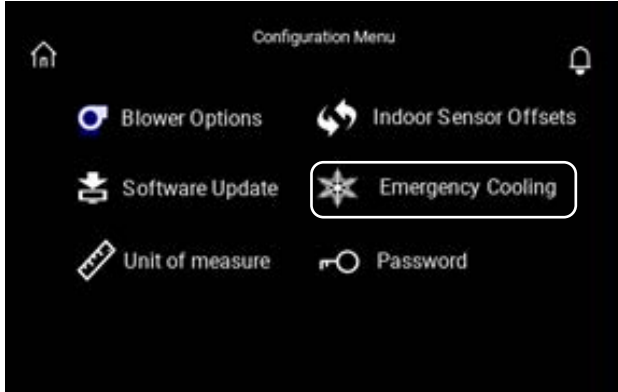


### Emergency Cool Screen

On the Configuration Menu Screen, press Emergency Cooling to go to the Emergency Cool Screen (see Figure 67).

**FIGURE 67**

#### Emergency Cooling on Configuration Menu Screen



To enable emergency cooling, toggle the Emergency Cool selector button to Enable (see Figure 68). To adjust the High Temp Alarm Setpoint, press on the temperature value which will open up a keyboard. Use the keyboard to input the desired temperature. The top left of the keyboard displays a Min and Max value.

Emergency cooling will be activated when the indoor temperature is above the high temperature alarm setpoint at the stand-alone display, the high space temperature (when unit is in stand-alone mode) or the high return temperature (when unit is in orphan mode). Emergency cooling will bring on all available options to cool the space, including full load compressor cooling.

See the latest revision of MEGA-TEC service instructions manual 2100-671 for more information on emergency cooling.

**FIGURE 68**  
Emergency Cool Screen



When the high indoor space temperature has risen above the alarm setpoint, the unit will enable emergency cooling. The unit will turn on all available

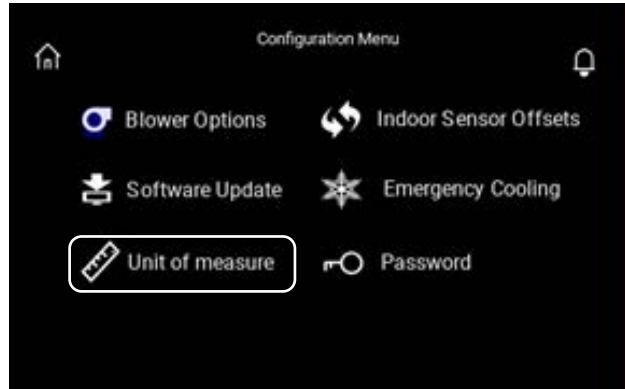
cooling and utilize the economizer if the outdoor air temperature is cooler than the indoor air temperature. The system will stay in emergency cooling until the indoor air temperature is below the cooling setpoint. This operation can be disabled by the end user.

### Unit of Measure Screen

On the Configuration Menu Screen, press Unit of Measure to go to the Unit of Measure Screen (see Figure 69).

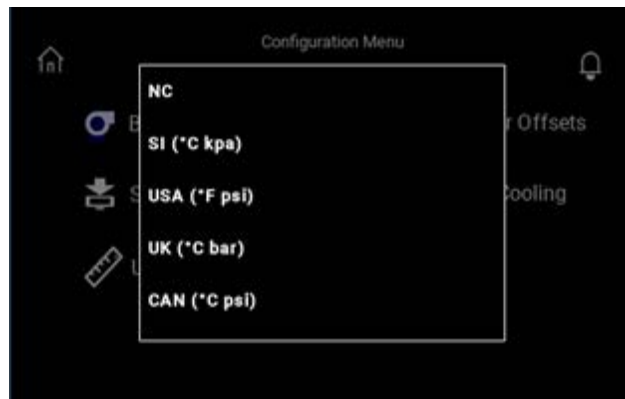
**FIGURE 69**

#### Unit of Measure on Configuration Menu Screen



A screen will pop up displaying a list of the unit of measure variations (see Figure 70). Press on the desired unit of measure to change it on the PGDx. When changing it on the PGDx, it will also change the unit of measure on the PGD/TEC-EYE.

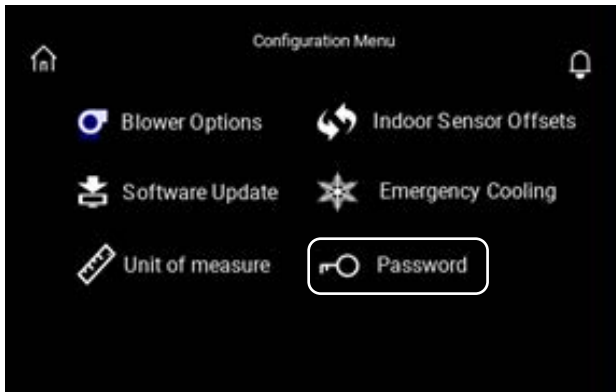
**FIGURE 70**  
Unit of Measure Popup Screen



## Password Screen

On the Configuration Menu Screen, press Password to go to the Password Screen (see Figure 71).

**FIGURE 71**  
**Password on Configuration Menu Screen**



The Password Screen displays the password used to log into the PGDx. When logging into the PGDx, this will carry over and log into the PGD as well. When logging in or out with the PGD, this will not log into or out of the PGDx.

The PGDx will automatically log the user out after 8 minutes of inactivity. After this timeout occurs, the user will need to log back in to be able to gain access to all the menus and features.

The password screen allows a default password to be changed. Press on the password to be changed and a keyboard will come up (see Figure 72). Type in the new password then hit enter and that password will now be the new password to use to log in.

**FIGURE 72**  
**Password Screen**

