

---

# SERVICE INSTRUCTIONS

---

## MEGA-TEC® Wall-Mount Air Conditioner

Models: W180B



*Climate Control Solutions*

Bard Manufacturing Company, Inc.  
Bryan, Ohio 43506  
[www.bardhvac.com](http://www.bardhvac.com)

Manual: 2100-749B  
Supersedes: 2100-749A  
Date: 7-20-22

# CONTENTS

<b>General Information</b> .....	<b>4</b>
Multi-Stage Cooling System .....	4
Wall-Mount Air Conditioner Units .....	4
General .....	4
Shipping Damage .....	4
Additional Publications .....	4
<b>Using the TEC-EYE™</b> .....	<b>6</b>
TEC-EYE Hand-Held Service Tool .....	6
TEC-EYE Acronyms .....	7
Main Status Screen .....	7
Quick Menu .....	7
Setpoints .....	7
Information .....	9
Air Path Information .....	9
A/C Circuit Information .....	9
24 Hour Run Time .....	10
Software Version .....	10
Software Versioning Guide .....	11
Alarm Log .....	11
Executing a Self Test .....	11
Self Test Parameter Descriptions .....	11
Reset to Factory Defaults .....	12
Configuration File .....	12
<b>Operation</b> .....	<b>13</b>
Unit On/Off .....	13
Alarm Adjustment .....	13
Acknowledging Alarms .....	13
Clearing Alarms .....	13
Clearing Alarm Logs and Counters .....	13
Exporting Alarm Logs .....	13
Exporting 7 Day Logs .....	14
Unit Address and Zone .....	14
Temperature Control .....	14
Temperature Control Components .....	14
Return Air Temperature Sensor .....	14
Return Air Temperature Sensor Alarm .....	14
Temperature Control Operation .....	15
Orphan Mode .....	15
LC6000 Control .....	15
Cooling .....	15
Heating .....	16
Electronic Expansion Valve (EEV) .....	17
EEV Components .....	17
Electronic Expansion Valve .....	17
EEV Instructions for Vacuum, Reclaim, Charge Unit .....	17
System Pressures .....	18
Suction Pressure Transducer .....	18
Troubleshooting the Suction Pressure Transducer .....	18
Suction Pressure Alarm .....	18
Suction Temperature Sensor .....	18
Suction Temperature Sensor Alarm .....	19
EEV Operation .....	19
EEV Superheat Control .....	19
Additional EEV Alarms .....	19
Low Superheat Alarm .....	19
Indoor Airflow .....	19
Indoor Airflow Components .....	19
Blower .....	19
Blower Status Switch .....	21
Blower Status Alarm .....	22
Filters .....	22
Dirty Filter Switch .....	22
Dirty Filter Alarm .....	22
Filter Indicator Light .....	23
Indoor Airflow Operation .....	24
Blower Speed Control .....	24
Freeze Condition Operation .....	24
High Sensible Operation .....	24
Balanced Climate™ Operation .....	24
Additional Indoor Airflow Alarms .....	25
Supply Air Temperature Sensor Alarm .....	25

Condenser Fan .....	25
Condenser Fan Components .....	25
Condenser Fan .....	25
Liquid Pressure Sensor .....	25
Troubleshooting the Discharge/Liquid Pressure Transducer .....	26
Discharge/Liquid Pressure Transducer Alarm .....	26
Liquid Temperature Sensor .....	26
Outdoor Temperature Sensor .....	26
Condenser Fan Operation .....	26
Condenser Fan Speed Control .....	26
Compressor .....	27
Compressor Components .....	27
Compressor .....	27
Compressor Control Module (CCM) .....	27
Delay-on-Make Timer .....	27
Short Cycle Protection/Delay-on-Break .....	27
High Pressure Detection .....	27
Test Mode .....	28
Brownout Protection w/Adjustment .....	28
High Pressure Safety Switch .....	29
Refrigerant High Pressure Alarm .....	29
Phase Monitor .....	29
Crankcase Heater .....	29
Compressor Operation .....	29
Additional Compressor Alarms .....	30
Refrigerant Low Pressure Alarm .....	30
Economizer .....	31
Economizer Components .....	31
Actuator .....	31
Dust Sensor .....	31
Dust Sample .....	32
Dust Sensor Failure Alarm .....	32
High Dust Limit Alarm .....	32
Damper Blade .....	33
Damper Switch .....	33
Damper Failed to Open Alarm .....	34
Damper Failed to Close Alarm .....	34
Outdoor Temperature and Humidity Combination Sensor .....	34
Outdoor Temperature Sensor Failure Alarm .....	35
Outdoor Humidity Sensor Failure Alarm .....	35
Mixed Air Temperature Sensor .....	35
High Mixed Air Temperature Alarm .....	35
Low Mixed Air Temperature Alarm .....	35
Economizer Operation .....	35
Economizer Operation – Minimum Position .....	37
Miscellaneous Components .....	38
Supply Temperature Sensor .....	38
Supply Temperature Sensor Failure Alarm .....	38
Emergency Cooling Mode .....	38
Emergency Cooling – Orphan Mode .....	38
Emergency Ventilation Mode .....	39
Electric Heat Option .....	39
Electric Heat Components .....	39
Electric Heating Element .....	39
Thermal Overload .....	40
Electric Heat Operation .....	40
Electric Reheat Dehumidification .....	40
Electric Reheat Dehumidification Operation .....	40
Unit Disable Option .....	41
Serial/Model Number Configuration .....	42
<b>Refrigerant Information</b> .....	<b>44</b>
General .....	44
Topping Off System Charge .....	44
Safety Practices .....	44
Important Installer Note .....	44
R410-A Refrigerant Charge .....	44
Pressure Service Ports .....	45
<b>Maintenance &amp; Troubleshooting</b> .....	<b>46</b>
Standard Maintenance Procedures .....	46

8301-089 Outdoor Temperature/Humidity Sensor .....	49
8301-089 Sensor Connections .....	49
8301-089 Outdoor Temperature Sensor Troubleshooting ..	50
8301-089 Humidity Sensor Test Value Outputs.....	52
8301-089 Outdoor Humidity Sensor Troubleshooting.....	52
8620-296 Supply Air Sensor/Return Air Sensor/Mixed Air Sensor/Suction Sensor/Liquid Sensor.....	54
8301-057 Blower Status Switch/Dirty Filter Switch.....	55
Compressor Solenoid .....	56
Compressor Solenoid Test Procedures.....	56
8612-064 Dust (Particulate) Sensor Control Board.....	57
8612-064 Control Board Output Signal Not Responsive...	57
8301-091 Dust (Particulate) Sensor .....	58
Variable Speed Blower/Condensate Fan.....	59
Maintenance.....	59
LED Warning/Status Codes .....	60
Modbus Troubleshooting .....	61
Alarm Index .....	64
I/O Layout.....	68

## FIGURES

Figure 1	TEC-EYE Display and Interface .....	6
Figure 2	TEC-EYE Connection to Unit Control.....	6
Figure 3	Quick Menu Icons.....	7
Figure 4	Cool and Heat Setpoints.....	9
Figure 5	MEGA-TEC Air Paths and Refrigeration Circuits .....	9
Figure 6	Unit Air Path Information .....	9
Figure 7	Last 24 Hour Tracking.....	10
Figure 8	A/C Circuit Measurements .....	10
Figure 9	Software Version .....	11
Figure 10	Executing Self Test.....	11
Figure 11	Restoring Factory Default Settings.....	12
Figure 12	Restoring Factory Default Settings – Remove USB Device .....	12
Figure 13	Clearing All Alarms .....	13
Figure 14	Clearing Alarm Logs and Counters .....	13
Figure 15	Changing Zone .....	14
Figure 16	Adjusting Return Air Temperature Sensor .....	14
Figure 17	Cooling (with Economizer) .....	15
Figure 18	Cooling (without Economizer).....	16
Figure 19	Heating .....	16
Figure 20	Adjusting Cooling Differentials.....	16
Figure 21	Adjusting Heating Differentials .....	17
Figure 22	Overriding EEV Output .....	17
Figure 23	Electronic Expansion Valve (EEV) and Service Tool .....	17
Figure 24	Adjusting Suction Sensor/Transducer Pressure Values .....	18
Figure 25	Voltage to Pressure: Suction Pressure Transducer.....	18
Figure 26	Adjusting Suction Temperature Sensor Values .....	19
Figure 27	Putting Blower Output into Override Mode .....	19
Figure 28	Verifying Blower Speeds State.....	20
Figure 29	Adjusting Emergency Vent and Freeze Speeds.....	20
Figure 30	Putting Blower into Custom Blower Mode .....	20
Figure 31	Custom Blower Screens.....	21
Figure 32	Dirty Filter Switch and Blower Status Switch.....	22
Figure 33	Verifying Differential Airflow Status .....	22
Figure 34	Dirty Filter Switch and Filter Indicator Light.....	23
Figure 35	Verifying Filter Light Status .....	23
Figure 36	Overriding Filter Light Output .....	24
Figure 37	Enabling/Disabling High Sensible or Balanced Climate Operation .....	25
Figure 38	Enabling Fan Override .....	25
Figure 39	Adjusting Discharge/Liquid Transducer Pressure Values .....	26
Figure 40	Voltage to Pressure: Discharge/Liquid Pressure Transducer.....	26
Figure 41	Adjusting Discharge/Liquid Temperature Input.....	26
Figure 42	Condenser Fan Discharge/Liquid Pressure Setpoint.....	27
Figure 43	8201-171 Compressor Control Module.....	28
Figure 44	Adjusting Compressor Delays .....	30
Figure 45	Verifying Compressor Output Status.....	30
Figure 46	Overriding Compressor Outputs.....	30

Figure 47	Damper Override.....	31
Figure 48	Dust Sensor .....	31
Figure 49	Verifying Dust Sample Output Status.....	32
Figure 50	Overriding Dust Sample Output.....	32
Figure 51	Adjusting Dust Sensor Alarm Setpoint .....	32
Figure 52	W180 Damper Blades.....	33
Figure 53	Damper Blade Position.....	33
Figure 54	Damper Switch.....	34
Figure 55	Outdoor Temperature Sensor.....	34
Figure 56	Outdoor Humidity Sensor .....	34
Figure 57	Mixed Air Temperature Sensors .....	35
Figure 58	Economizer Setup.....	36
Figure 59	Economizer Setup – Dry Bulb Control .....	37
Figure 60	Economizer Setup – TempHum Control .....	37
Figure 61	Economizer Setup – Enthalpy Control .....	37
Figure 62	Supply Air Temperature Sensor .....	38
Figure 63	Emergency Cool – Orphan Mode .....	38
Figure 64	Adjusting Return Air Alarm Settings .....	39
Figure 65	Verifying Electric Heat Output Status.....	39
Figure 66	Overriding Electric Heat Output .....	39
Figure 67	Electric Reheat Dehumidification .....	40
Figure 68	Dehumidification Control (°F).....	40
Figure 69	Unit Disable Option .....	41
Figure 70	Verifying Damper Power Output Status.....	41
Figure 71	Overriding Damper Output .....	42
Figure 72	Serial/Model Number Configuration .....	42
Figure 73	MEGA-TEC Model Nomenclature.....	43
Figure 74	Sensors and Peripheral Devices.....	47
Figure 75	Supply and Return Air Sensors.....	48
Figure 76	8301-089 Sensor Electrical Connections and DIP Switches .....	49
Figure 77	8301-089 Sensor Terminal Connections .....	49
Figure 78	8301-089 Sensor: Temperature Probe Troubleshooting.....	50
Figure 79	8301-089 DIP Switch/Output Configuration .....	52
Figure 80	8301-089 Sensor: Humidity Probe Troubleshooting.....	52
Figure 81	8301-057 Air Differential Switch.....	55
Figure 82	Compressor Solenoid Location .....	56
Figure 83	8612-064 Dust Sensor Alarm Board .....	57
Figure 84	Fan Terminals .....	59
Figure 85	PLC Communication Wires.....	61
Figure 86	Expansion Module Communication Wires.....	61
Figure 87	Blower/Condenser Fan Communication Wires.....	61
Figure 88	Communication Wires in Terminal Block .....	62
Figure 89	DIP Switch Location .....	62
Figure 90	Correct DIP Switch Settings.....	62
Figure 91	TEC-EYE Blower 1 Screen.....	62
Figure 92	TEC-EYE Condenser Fan 1 Screen.....	63
Figure 93	Ventilation Airflow Paths.....	67
Figure 94	I/O Layout.....	68
Figure 95	I/O Layout.....	69

## TABLES

Table 1	TEC-EYE Menu Structure .....	7
Table 2	LC6000/TEC-EYE Passwords (Defaults) .....	7
Table 3	Unit Status Messages.....	8
Table 4	Software Versioning Guide .....	11
Table 5	Unit Specific Superheat Setpoints.....	19
Table 6	Rated Airflow .....	21
Table 7	Indoor Blower Performance.....	21
Table 8	Maximum ESP of Operation: Electric Heat Only ..	21
Table 9	W180 Blower Speed Settings .....	24
Table 10	Condenser Fan Nominal Speed .....	27
Table 11	Economizer Default Settings.....	37
Table 12	W180 Cooling Pressures .....	45
Table 13	8301-089 Sensor: Temperature/Resistance .....	51
Table 14	8301-089 Sensor: Humidity/mA .....	53
Table 15	8620-296 Sensor: Temperature/Resistance Curve J.....	54
Table 16	Solenoid Coil Resistance .....	56
Table 17	8301-091 Sensor: Dust/Volts .....	58
Table 18	Blower/Condenser Fan Troubleshooting .....	60
Table 19	Blower/Condenser Fan Motor Flash Codes .....	60
Table 20	Modbus Device Communication Wires.....	61

# GENERAL INFORMATION

---

## Multi-Stage Cooling System

The Bard air conditioning system is composed of MEGA-TEC wall-mounted air conditioners matched with an LC6000 supervisory controller or Bard PGD/PGDx stand-alone display. If only one wall-mounted air conditioner is being used, it can be matched with either the LC6000 supervisory controller or a stand-alone display. If more than one wall-mount unit is installed, the LC6000 controller must be matched with the air conditioning units. The wall mounts are specifically engineered for telecom/motor control center rooms.

**NOTE:** *The LC6000 supervisory controller or stand-alone display and MEGA-TEC Series wall-mount units are designed specifically to work together. The controller or stand-alone display cannot run other brands of systems, nor can other controllers run the MEGA-TEC Series wall-mount units. They are a complete system, and must be used together. See manual 2100-669 for more information about the LC6000 controller, manual 2100-734 for the PGD and manual 2100-740 for the PGDx.*

## Wall-Mount Air Conditioner Units

The wall-mount units operate on VAC power. If equipped with an economizer, the units will supply full rated cooling airflow in free cooling mode with ability to exhaust the same amount through the unit itself without any additional relief openings in the shelter.

MEGA-TEC units are fully charged with refrigerant and are available with optional electric heat and/or electric reheat dehumidification.

**NOTE:** *575V models take incoming field power and step-down secondary to 460V which supplies most components **except** compressors and electric heat which remain 575V. Reference wiring diagrams for more information.*

## General

The equipment covered in this manual is to be installed by trained, experienced service and installation technicians.

The refrigerant system is completely assembled and charged. All internal wiring is complete.

The unit is designed for use without duct work. Flanges are provided for transition from unit to wall grilles.

These instructions and any instructions packaged with any separate equipment required to make up the entire air conditioning system should be carefully read before beginning the installation. Note particularly any tags and/or labels attached to the equipment.

While these instructions are intended as a general recommended guide, they do not supersede any national and/or local codes in any way. Authorities having

jurisdiction should be consulted before the installation is made. See **Additional Publications** for information on codes and standards.

Sizing of systems for proposed installation should be based on heat loss and heat gain calculations made according to methods of Air Conditioning Contractors of America (ACCA). The supply flange should be installed in accordance with the *Standards of the National Fire Protection Association for the Installation of Air Conditioning and Ventilating Systems of Other Than Residence Type, NFPA No. 90A*, and *Residence Type Warm Air Heating and Air Conditioning Systems, NFPA No. 90B*. Where local regulations are at a variance with instructions, installer should adhere to local codes.

## Shipping Damage

Upon receipt of equipment, the cartons should be checked for external signs of shipping damage. If damage is found, the receiving party must contact the last carrier immediately, preferably in writing, requesting inspection by the carrier's agent.

**These units must remain in upright position at all times; do not lay on side. Do not stack units.**

## Additional Publications

These publications can help when installing the air conditioner. They can usually be found at the local library or purchased directly from the publisher. Be sure to consult the current edition of each standard.

National Electrical Code.....ANSI/NFPA 70  
Standard for the Installation of Air Conditioning  
and Ventilating Systems .....ANSI/NFPA 90A  
Standard for Warm Air Heating  
and Air Conditioning Systems .....ANSI/NFPA 90B  
Load Calculation for Residential Winter  
and Summer Air Conditioning ..... ACCA Manual J

For more information, contact these publishers:

**Air Conditioning Contractors of America (ACCA)**  
1712 New Hampshire Ave. N.W.  
Washington, DC 20009  
Telephone: (202) 483-9370 Fax: (202) 234-4721

**American National Standards Institute (ANSI)**  
11 West Street, 13th Floor  
New York, NY 10036  
Telephone: (212) 642-4900 Fax: (212) 302-1286

**American Society of Heating, Refrigeration and Air  
Conditioning Engineers, Inc. (ASHRAE)**  
1791 Tullie Circle, N.E.  
Atlanta, GA 30329-2305  
Telephone: (404) 636-8400 Fax: (404) 321-5478

**National Fire Protection Association (NFPA)**  
Batterymarch Park  
P. O. Box 9101  
Quincy, MA 02269-9901  
Telephone: (800) 344-3555 Fax: (617) 984-7057

**ANSI Z535.5 Definitions:**

**DANGER:** Indicate[s] a hazardous situation which, if not avoided, will result in death or serious injury. The signal word “DANGER” is to be limited to the most extreme situations. DANGER [signs] should not be used for property damage hazards unless personal injury risk appropriate to these levels is also involved.

**WARNING:** Indicate[s] a hazardous situation which, if not avoided, could result in death or serious injury. WARNING [signs] should not be used for property damage hazards unless personal injury risk appropriate to this level is also involved.

**CAUTION:** Indicate[s] a hazardous situation which, if not avoided, could result in minor or moderate injury. CAUTION [signs] without a safety alert symbol may be used to alert against unsafe practices that can result in property damage only.

**NOTICE:** [this header is] preferred to address practices not related to personal injury. The safety alert symbol shall not be used with this signal word. As an alternative to “NOTICE” the word “CAUTION” without the safety alert symbol may be used to indicate a message not related to personal injury.



## WARNING

***Electrical shock hazard.***

***Have a properly trained individual perform these tasks.***

***Failure to do so could result in electric shock or death.***

## WARNING

***Fire hazard.***

***Maintain minimum 1/4" clearance between the supply flange and combustible materials.***

***Failure to do so could result in fire causing damage, injury or death.***

## WARNING

***Heavy item hazard.***

***Use more than one person to handle unit.***

***Failure to do so could result in unit damage or serious injury.***

## CAUTION

***Cut hazard.***

***Wear gloves to avoid contact with sharp edges.***

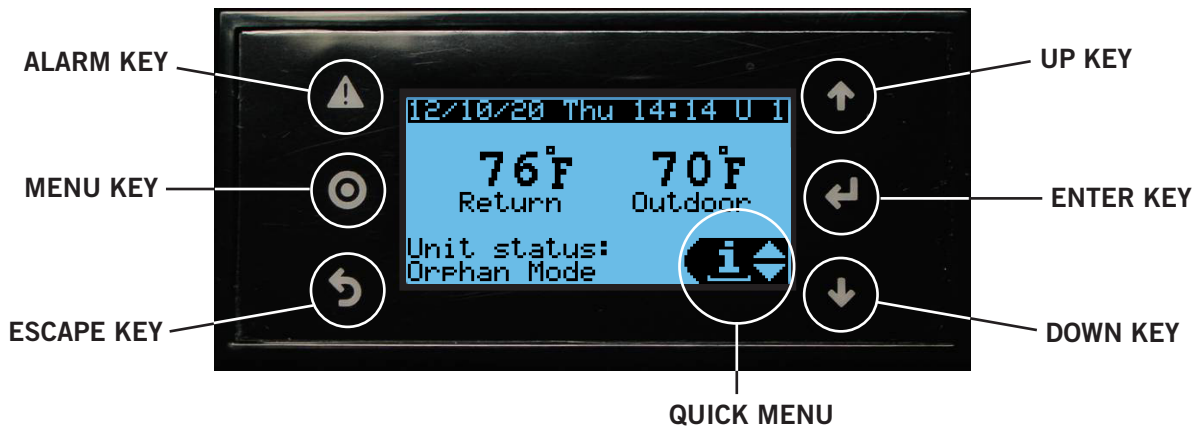
***Failure to do so could result in personal injury.***

### IMPORTANT

*When connecting this product from a remote location, ensure that the network connection is secure and reliable.*

# USING THE TEC-EYE™

FIGURE 1  
TEC-EYE (Bard P/N 8301-059) Display and Interface (Status Screen Shown)



- ALARM KEY**  
Allows viewing of active alarms  
Silences audible alarms  
Resets active alarms
- MENU KEY**  
Allows entry to Main Menu
- ESCAPE KEY**  
Returns to previous menu level  
Cancels a changed entry

- UP KEY**  
Steps to next screen in the display menu  
Changes (increases) the value of a modifiable field
- ENTER KEY**  
Accepts current value of a modifiable field  
Advances cursor
- DOWN KEY**  
Steps back to previous screen in the display menu  
Changes (decreases) the value of a modifiable field

## TEC-EYE Hand-Held Service Tool

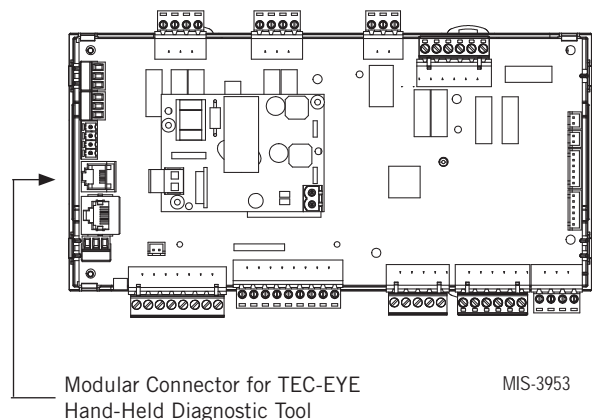
The TEC-EYE service tool is used to communicate with the MEGA-TEC unit logic board. By connecting directly to the logic board inside the unit control panel, it is possible to perform diagnostics on the unit, adjust certain settings and verify unit and economizer operation through a self test procedure. **The TEC-EYE service tool is required for unit setup and operation.** The TEC-EYE is supplied with the LC6000 controller but can also be ordered separately (Bard P/N 8301-059).

The menu driven interface provides users the ability to scroll through two menu levels: Quick Menu and Main Menu. The menus permit the user to easily view, control and configure the unit. See Figure 1 for TEC-EYE display and key functions.

The controller is completely programmed at the factory; the default setpoints and their ranges are easily viewed and adjusted from the TEC-EYE display. The program and operating parameters are permanently stored on FLASH-MEMORY in case of power failure.

The TEC-EYE connects to the wall-mount unit control board via an RJ11 modular phone connector as shown in Figure 2.

FIGURE 2  
TEC-EYE Connection to Unit Control



When not being used, the TEC-EYE hand-held diagnostic tool should be stored inside or near the LC6000 controller. Do not let the TEC-EYE leave the shelter.

**NOTE:** Screenshots shown in this manual reflect default settings (when applicable).

**TABLE 1  
TEC-EYE Menu Structure**

Menu/Screen Structure	Password Level Required
<i>Quick Menu</i>	
Setpoints (Orphan Mode Temperature Control)	None
Information	None
Alarm Log	None
<i>Main Menu</i>	
System Config	User
Adv. Sys. Config	Technician
I/O Config	Technician
Digital Inputs	Technician
Digital Outputs	Technician
Analog Inputs	Technician
Analog Outputs	Technician
Fan/Blowers	Technician
Manual EEV	Technician
On/Off	User
Alarm Logs	User
Settings	--
Date/Time	Technician
Initialization	Technician
Change Passwords	Varies
Logout	--

**TABLE 2  
LC6000/TEC-EYE Passwords (Defaults)**

User	2000
Technician	1313
Engineer	9254
Use UP or DOWN keys and ENTER key to enter password. The passwords listed above are the default passwords. End users can change these passwords if additional security is desired.	

**TEC-EYE Acronyms**

MAT – Mixed air temperature  
 RAT – Return air temperature  
 SAT – Supply air temperature

OAT – Outdoor air temperature  
 OAH – Outdoor air humidity  
 Blower – Indoor blower speed  
 Fan – Outdoor fan speed  
 Damper – Free cooling

**Main Status Screen**

The main Status screen is the default start-up screen and also the return screen after 5 minutes of no activity. The screen can be accessed at any time by pressing the ESCAPE key repeatedly.

The wall-mount unit address is displayed in the upper right corner on the main Status screen (see Figure 1). The main Status screen also shows the current date, return air temperature (RAT), outdoor air temperature (OAT) and unit status. See Table 3 on page 8 for wall-mount unit status messages.

The Quick Menu is accessible from the main Status screen. Setpoints, Information and Alarm Log are available through the Quick Menu. Pressing the UP or DOWN keys while on the main Status screen will change the Quick Menu icon displayed (see Figure 3). Press the ENTER key when the desired icon is displayed.

**FIGURE 3  
Quick Menu Icons**



**Quick Menu**

**Setpoints**

From this screen, the local unit heating and cooling setpoints can be changed.

Once the supervisory controller is connected, cooling and heating setpoints will be communicated and local cooling and heating setpoints will be replaced with the communicated cooling and heating setpoints.

If at any time the wall-mount unit(s) loses communication with the LC6000 controller, the wall-mount unit(s) will go into orphan mode and operate using the last communicated setpoints.

To verify or change the wall-mount unit cooling and heating setpoints in orphan mode:

1. Connect the TEC-EYE diagnostic tool to the control board located in the unit.
2. From the Status screen, press UP or DOWN key until Quick Menu displays Setpoints icon. Press ENTER key.
3. Press ENTER key to scroll to the selected choice (see Figure 4 on page 9).
4. Press UP or DOWN key on desired value until value displays correctly.

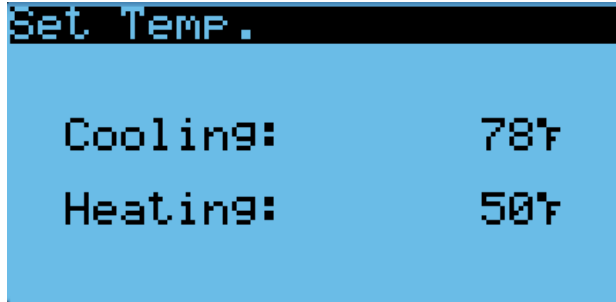
**TABLE 3**  
**Unit Status Messages**

Message	Description
Orphan Mode	This message will be shown when unit is not connected to the LC or stand-alone display. The unit is not operating when this message is shown but is ready to heat or cool based on the return air temperature. Blower will run continuously in this mode.
Standalone Mode	This message will be shown when the unit is communicating with stand-alone display. The unit is not operating when this message is shown but is ready to heat or cool based on the display temperature sensor.
LC Online	This message will be shown when the unit is communicating with the LC6000. The unit is not operating when this message is shown but is ready to respond to any call or event from the LC.
Cont. Blower	The message will be shown when the unit has been commanded to run the blower continuously by the LC6000 or the stand-alone display.
Comfort Mode	This message will be shown when the unit has been put into comfort mode by the stand-alone display.
Freecooling	This message will be shown when the unit is utilizing the economizer to cool the space.
Passive Dehum	This message will be shown when the unit is connected to the LC6000 or stand-alone display and the economizer is disabled and blower speeds have been lowered to optimize moisture removal.
Cooling	This message will be shown when the unit is operating the air conditioning system to cool the space.
Heating	This message will be shown when the unit is operating the electric heaters to warm the space.
Optimized	This message will be shown when the unit is operating both the economizer and the air conditioning simultaneously to cool the space.
Active Dehum	This message will be shown when the unit is connected to the LC6000 or stand-alone display, no heating or cooling calls are required and the air conditioner and electric heat are being used together to remove moisture from the space.
Self Test	This message will be shown when the self test has been activated and component operations are being verified.
Off by Alarm	This message will be shown when the blower, fan or expansion module are no longer communicating with the main controller. Also, when unit disable, emergency off or no return sensor is detected in orphan mode.
Emergency Vent	This message will be shown when connected to a LC6000 and the emergency vent input is activated.
Emergency Cool	This message will be shown when the space temperature is above the high temperature setpoint. This can be active in orphan mode, stand-alone mode or when connected to the LC6000.
Emergency Off	This message will be shown when unit disable input is active, or when connected to LC6000 and emergency off input is active.
Off by LC	This message will be shown when connected to the LC6000 and the system is turned off.
Off by PGDx	This message will be shown when connected to the stand-alone display and the unit is turned off.
Off by Keyboard	This message will be shown when unit has been turned off at unit.
Model Invalid	This message will be shown when a valid model number is not entered into the controller.



5. Press ENTER key to save and scroll to next parameter.
6. Press ESCAPE key until Main Menu screen is displayed.

**FIGURE 4**  
**Cool and Heat Setpoints**



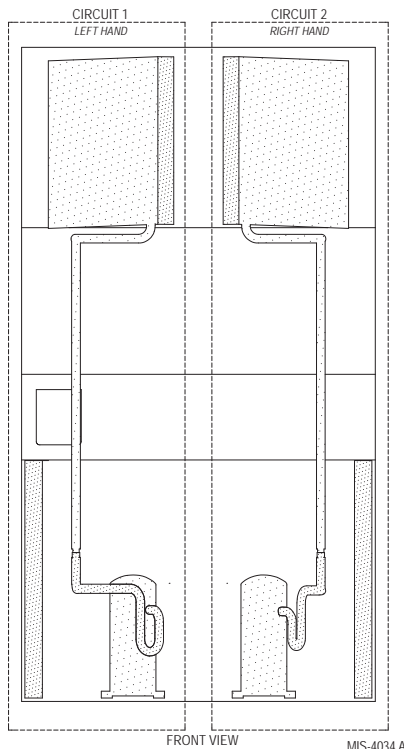
**Information**

The information screens are used as a quick reference to show unit A/C circuit measurements and program version.

*Air Path Information*

MEGA-TEC Series wall-mounted 15 ton air conditioners use two separate air paths: Air path 1 is tied to A/C circuit 1 and is located on the left side of the unit when viewed from the outdoor side and air path 2 is tied to A/C circuit 2 and is located on the right side of the unit when viewed from the outdoor side (see Figure 5).

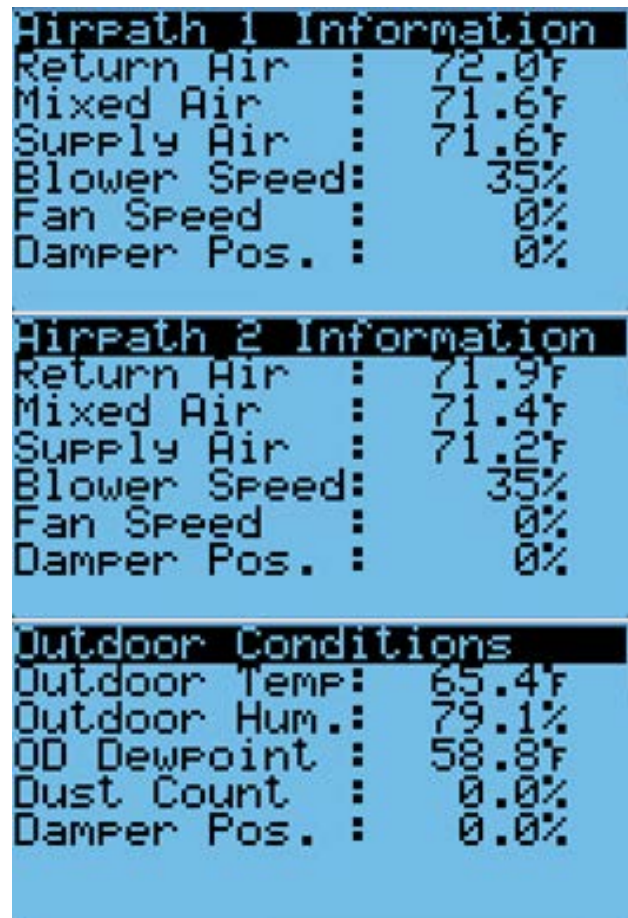
**FIGURE 5**  
**MEGA-TEC Air Paths and Refrigeration Circuits**



Both air paths share a single return air temperature sensor located in the return duct opening, but each air path has its own mixed air temperature sensor and supply air temperature sensor.

Unit air path and outdoor conditions can be found on three screens within the information menu (see Figure 6). The information and measurements provided are return air temperature, air path specific mixed air temperature (economizer-equipped units only), air path specific supply air temperature, air path specific blower speed, affiliated A/C circuit condenser fan speed and damper position (economizer-equipped only). Outdoor conditions provided include outdoor temperature, outdoor humidity, calculated outdoor dew point, dust concentration (economizer-equipped units only with dust sensor enabled) and damper position (economizer-equipped units only).

**FIGURE 6**  
**Unit Air Path Information**



*A/C Circuit Information*

MEGA-TEC Series wall-mounted air conditioners have two separate refrigeration circuits: Circuit 1 is located on the left side of the unit and circuit 2 is on the right side (see Figure 5).

Circuit 1 utilizes a 2 stage scroll compressor while circuit 2 uses a single stage compressor. Both circuits are equipped with an electronic expansion valve that is used to control superheat of each circuit. Liquid temperature and pressure are measured to provide a calculated subcooling for each circuit. Suction temperature and pressure are also measured to provide a calculated superheat for each circuit.

Using both circuit 1 and circuit 2, the MEGA-TEC unit can provide 35%, 80% and 100% cooling capacity. Separate refrigeration circuits also allow for operation of the unit at partial capacity if service is required on one circuit.

A/C Circuit Information can be found in four screens within the information menu (see Figure 8). The information and measurements provided are liquid line temperature, liquid line pressure, condensing saturated temperature, suction line temperature, suction line pressures, suction saturated temperature, super heat, subcooling and electronic expansion valve position.

#### 24 Hour Run Time

The Last 24 Hour Tracking screens display unit run times over the last 24 hour period (see Figure 7). The **Run** column displays the active times the component(s) were in ON state, while the **St** (Start) column shows the number of starts or times the component changed from an OFF to an ON state.

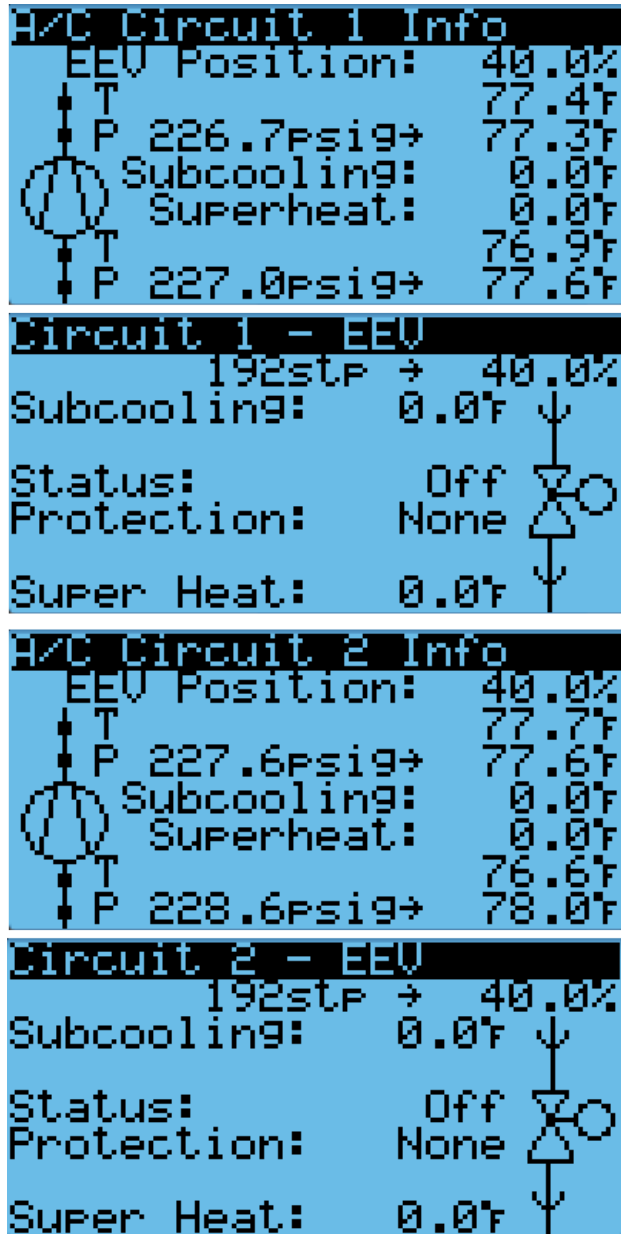
**FIGURE 7**  
Last 24 Hour Tracking

Last 24 Hour Tracking		
	Run	St
Unit	1281m	11
Freecool	1m	2
Cooling 1	1m	2
Cooling 2	1m	2
Cooling 3	0m	1
Heating 1	1m	3

Last 24 Hour Tracking		
	Run	St
Heating 2	0m	3
Blower 1	1280m	14
Blower 2	1282m	8
Fan 1	0m	0
Fan 2	0m	0

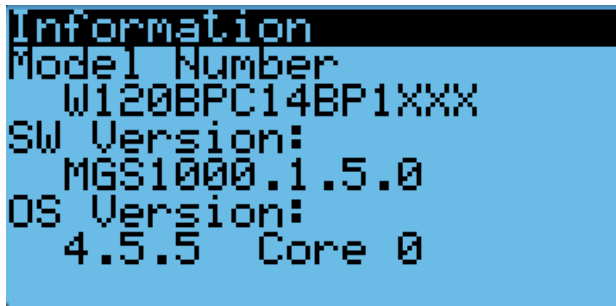
**FIGURE 8**  
A/C Circuit Measurements



#### Software Version

The Software Version screen displays all program version information for the PLC (see Figure 9). This information can be used to determine whether a software update may be required.

**FIGURE 9**  
Software Version



*Software Versioning Guide*

MGS1000.X.Y.Z

Software Name: The name of the software is the base part number used to identify which product the software is used in.

**TABLE 4**  
Software Versioning Guide

Product	Software Name
MULTI-TEC	MTS1000
FUSION-TEC (WR)	WTS1000
MEGA-TEC	MGS1000
LC6000	LCS6000

X: The letter X represents a major change to the software effecting product compatibility or function of the equipment.

Y: The letter Y represents a minor change to the software that either adds, removes or alters a feature of the equipment.

Z: The letter Z represents a change to the software that fixes existing features or user interface.

# NOTICE

*It is important to check the software version during installation to ensure that the latest version has been installed. Current software versions and installation instructions are available on the Bard website at <http://www.bardhvac.com/software-download/>*

## Alarm Log

The alarm log screens show a log of each alarm. There will be a log for when alarm occurred and if the alarm auto clears, it will show when the alarm cleared. See page 13 for information on clearing alarms.

## Executing a Self Test

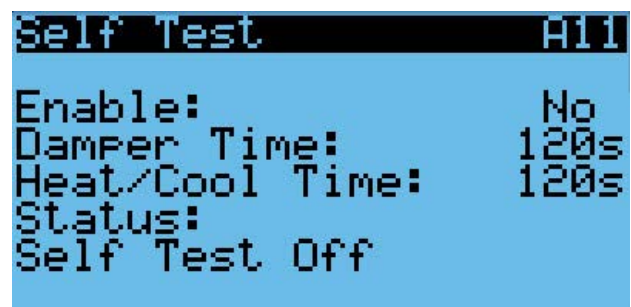
This unit has the ability to perform a self test that will operate all available unit functions in order to quickly determine unit operation. With the exception of step times, self test parameters are not adjustable.

The self test will automatically skip sections of the test based on the model number entered into the controller. If position 10 of the model number is B (to indicate "no vent" option), the economizer open and close steps will be skipped. If positions 8 and 9 of the model number indicate a OZ (0 kW) option, steps G,H and I will be skipped. If position 8 and 9 indicate a 09 (9 kW) option, step H will be skipped.

To execute a self test:

1. Press MENU key to access the Main Menu screen.
2. Press UP or DOWN keys and ENTER key to enter TECHNICIAN password 1313.
3. Press UP or DOWN keys to scroll to **Sys Config**; press ENTER key.
4. Press UP or DOWN keys to scroll to **Self Test A11** screen.
5. Press ENTER key to scroll to **Enable** parameter (see Figure 10).
6. Press UP or DOWN key to change value to **Yes**. The self test will begin.

**FIGURE 10**  
Executing Self Test



## Self Test Parameter Descriptions

Damper Time: This is the time (in seconds) allowed for both the opening sequence and closing sequence.

Heat/Cool Time: This is the time (in seconds) allowed for cooling sequence and heating sequence.

Status: This will display what the unit is doing as the self test progresses. The following messages may appear:

Self Test Off  
 Initializing...  
 Opening Dampers  
 Closing Dampers  
 Compressor 1 On  
 Compressor 1 & 2 On  
 C1 Full Load + C2 On  
 Turning Comp. Off...  
 Electric Heat 1 On  
 Electric Heat 1 & 2 On  
 Turning Heat Off...

End

The unit will determine which items to test based on the unit model number.

**Reset to Factory Defaults**

To reset to factory default settings:

1. Press MENU key to go to the Main Menu screen.
2. Use UP or DOWN keys and ENTER key to enter ENGINEER password 9254.
3. Press UP or DOWN keys to scroll to **Settings**; press ENTER key.
4. Press UP or DOWN keys to scroll to **Initialization**; press ENTER key.
5. Press UP or DOWN keys to scroll to the **DEFAULT INSTALLATION** screen.
6. Press ENTER key to scroll to **Reset to Factory Defaults**: (see Figure 11).

**FIGURE 11**  
 Restoring Factory Default Settings



7. Press UP or DOWN key to change value to **YES**; press ENTER key.
8. System will restart with default values.

The controller can only be factory reset when the USB port is not in use. When the USB port is in use, a message will appear and the option to reset factory defaults will not be available (see Figure 12).

**FIGURE 12**  
 Restoring Factory Default Settings –  
 Remove USB Device



**Configuration File**

The controller will automatically save all of the configured parameters to a file that can be accessed by connecting a laptop to the controller with a micro USB cable. This file can be used to copy the setting of one board to another board.

The file is located in the main directory of the controller and is labeled "MG\_Config". Copy this file to a location on the laptop and then disconnect from the first board. Connect to the second board and copy the file to the second board. Disconnect the laptop from the second board and power cycle the controller. The second board will now have the same settings as the first board.

## Unit On/Off

The wall-mount unit can be turned on and off from the TEC-EYE. Turning the unit off with the following instructions will disable all unit operation.

To turn the unit on or off:

1. Press MENU key to go to the Main Menu screen.
2. Press UP or DOWN keys and ENTER key to enter USER password 2000.
3. Press UP or DOWN keys to scroll to **On/Off**; press ENTER key.
4. Press UP or DOWN keys to change value from **On** to **Off** or from **Off** to **On**.
5. Press ESCAPE key several times to return to Main Menu screen.

The wall-mount unit may also be turned off by certain events such as the unit disable input (if enabled), blower offline/loss of communication, fan offline/loss of communication, panel removed or the return air temperature sensor failure when not connected to the LC6000.

The unit can also be manually turned off by the PGDx and the LC6000.

## Alarm Adjustment

### Acknowledging Alarms

On the standard TEC-EYE included with the LC6000 controller (Bard P/N 8301-059), alarm conditions are enunciated by an audible alarm signal. On the larger TEC-EYE (Bard P/N 8301-053), alarm conditions activate a red LED indicator that backlights the ALARM function key. An alarm is acknowledged by pressing the ALARM key. This calls up alarm display screen(s) that provide a text message detailing the alarm condition(s).

### Clearing Alarms

Alarms can only be cleared after the alarm condition has been corrected. To clear a single alarm, press and hold the ALARM key for 3 seconds while viewing a specific alarm screen. To clear all alarms, navigate to the screen at the end of the alarm list (shown in Figure 13) and press and hold the ALARM key for 3 seconds.

FIGURE 13  
Clearing All Alarms

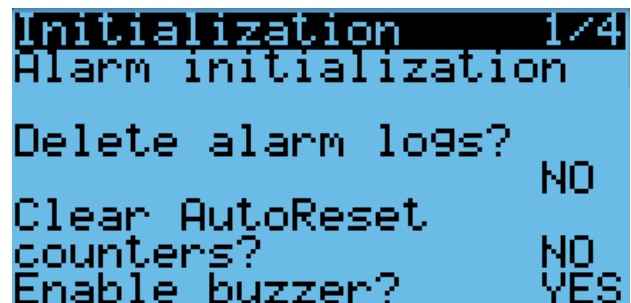


### Clearing Alarm Logs and Counters

To clear the alarm log and alarm counters:

1. Press MENU key to go to the Main Menu screen.
2. Use UP or DOWN keys and ENTER key to enter USER password 2000.
3. Press UP or DOWN keys to scroll to **Settings**; press ENTER key.
4. Press UP or DOWN keys to scroll to **Initialization**; press ENTER key. (**Alarm initialization** screen will be displayed.)
5. Press ENTER key to scroll to **Delete alarm logs?** (see Figure 14).
6. Press UP or DOWN key to change value to **YES**; press ENTER key.
7. Press ENTER key to scroll to **Clear AutoReset counters?**
8. Press UP or DOWN key to value to **YES**; press ENTER key.

FIGURE 14  
Clearing Alarm Logs and Counters



### Exporting Alarm Logs

See latest version of Supplemental Instructions manual 7960-825 for information on exporting alarm logs.

## Exporting 7 Day Logs

See latest version of Supplemental Instructions manual 7960-826 for information on exporting 7 day I/O logs.

## Unit Address and Zone

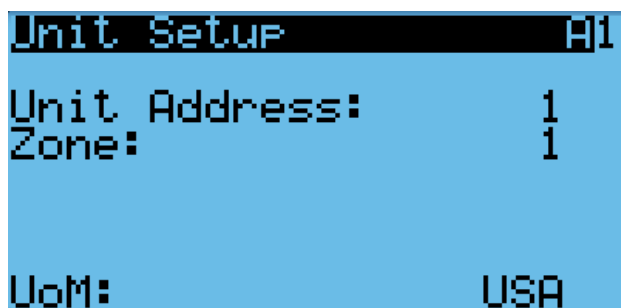
Each unit must have a unique address for the system to operate correctly with the LC supervisory controller (Ex: 1, 2, 3, ...14 depending on the number of units). The unit only needs the address to be changed for the communication to work properly.

When paired with a supervisory controller that uses zones to control groups of wall units, each unit uses the zone setting to relay to the supervisory controller what zone it is set to operate in. Up to three zones can be established with up to 14 units in a single zone. (The LC6000 supervisory controller can control up to a total of 14 units.)

To change the unit address and/or zone:

1. Press MENU key to access the Main Menu screen.
2. Press UP or DOWN keys and ENTER key to enter TECHNICIAN password 1313.
3. Press UP or DOWN keys to scroll to **Sys Config**; press ENTER key.
4. Press UP or DOWN keys to scroll to **Unit Setup A1** screen.
5. Press ENTER key to scroll to **Unit Address** (see Figure 15).
6. Press UP or DOWN keys to change the address to a value between 1 and 14.
7. Press ENTER key to scroll to **Zone**.
8. Press UP or DOWN keys to change to the desired value (1, 2 or 3).
9. Press ENTER key to save value.

**FIGURE 15**  
Changing Unit Address or Zone



**NOTE:** Each unit must have a unique address for the communication to work properly. Unit addresses can only be used once per LC6000 regardless of number of zones. Bard also recommends physically labeling each unit for ease in identification.

## Temperature Control

### Temperature Control Components

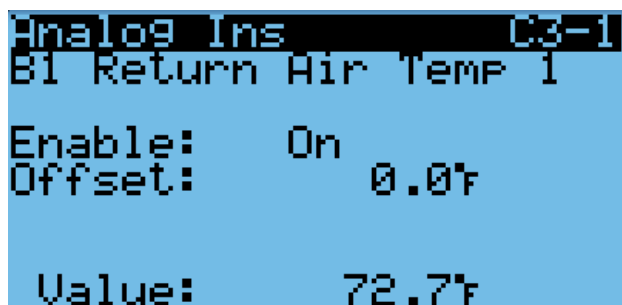
#### Return Air Temperature Sensor

The unit is equipped with a return air temperature sensor to monitor the space temperature when the unit is in orphan mode. The return air sensor is located in the return opening for air path/circuit 1 in such a way that it is exposed to the entering airstream. An alarm signal will be sent to the LC controller if the return air temperature sensor is disconnected. The temperature is measured with a 10k ohm NTC thermistor.

This sensor can be verified and adjusted by:

1. Press MENU key to go to the Main Menu screen.
2. Press UP or DOWN keys and ENTER key to enter TECHNICIAN password 1313.
3. Press UP or DOWN keys to scroll to **I/O Config**; press ENTER key.
4. Press UP or DOWN keys to scroll to **Analog Inputs**; press ENTER key.
5. Press UP or DOWN keys to scroll to **Analog Ins C3-1**.
6. Verify the measurement displayed on screen is accurate (see Figure 16).
7. If the measurement needs to be adjusted, apply an offset value by pressing ENTER to scroll to **Offset**.
8. Press UP or DOWN keys to adjust the offset.
9. The update will not take effect until the cursor is moved out of the **Offset** parameter.
10. Once adjusted, press the ESCAPE key several times to return to Main Menu screen.

**FIGURE 16**  
Adjusting Return Air Temperature Sensor



#### Return Air Temperature Sensor Alarm


When the return air temperature sensor value is out of range (-41.0 to 303.0°F), the controller will generate a sensor failure alarm to indicate the sensor is not working properly.

This alarm is fixed and cannot be adjusted.

## Temperature Control Operation

The unit utilizes differentials while in orphan mode to control the space temperature. The differential values all reference the setpoint therefore allowing the control band to be easily changed using the setpoint. To change specific staging characteristics, each differential can be modified individually. There are separate setpoints and differentials for cooling and heating. Specific to the cooling differentials, the economizer will always be utilized first on a cooling call unless outdoor conditions are not acceptable for free cooling. In this case, the compressor will be activated at stage 1 in place of the economizer. All remaining stages will be shifted until the economizer becomes available again.

To change or view the unit setpoint:

1. From the Status screen, press UP or DOWN key until Quick Menu displays Setpoints icon (  ). Press ENTER key.
2. Press ENTER key to scroll to **Cool Setpoint** or **Heat Setpoint** (see Figure 4 on page 9).
3. Press UP or DOWN keys to change the value to desired heating and/or cooling setpoint.

### Orphan Mode

MEGA-TEC Series wall-mount units have the capability to run without the LC6000 controller attached—this feature is called orphan mode. This keeps the shelter between 60°F and 77°F (factory default settings) by the use of the factory-installed return air sensor in each wall-mount unit. In orphan mode, no auxiliary temperature measurement devices are required for operation. The wall-mount unit automatically uses a continuous blower setting to circulate room air into the return air inlet and uses the return air temperature sensor to control room temperature.

If at any time the wall-mount unit(s) loses communication with the LC6000 controller, the wall-

mount unit(s) will go into orphan mode and operate using the last communicated setpoints.

To change default setpoints, refer to **Setpoints** on page 7.

During installation, the ability to run in orphan mode allows deactivation of one of the existing, older wall-mount units, while keeping the shelter cool with the other unit still operating. Once the first of the Bard wall-mount units is installed and powered on, it will operate in orphan mode—keeping the climate inside the shelter stable and the installers comfortable while the remainder of the older equipment is removed and the remaining Bard wall-mount units and LC6000 controller are installed.

Additionally, should any or all of the MEGA-TEC Series wall-mount units lose communication with the LC6000 controller (such as during maintenance), they will continue to serve the shelter’s needs until a repair can be made.

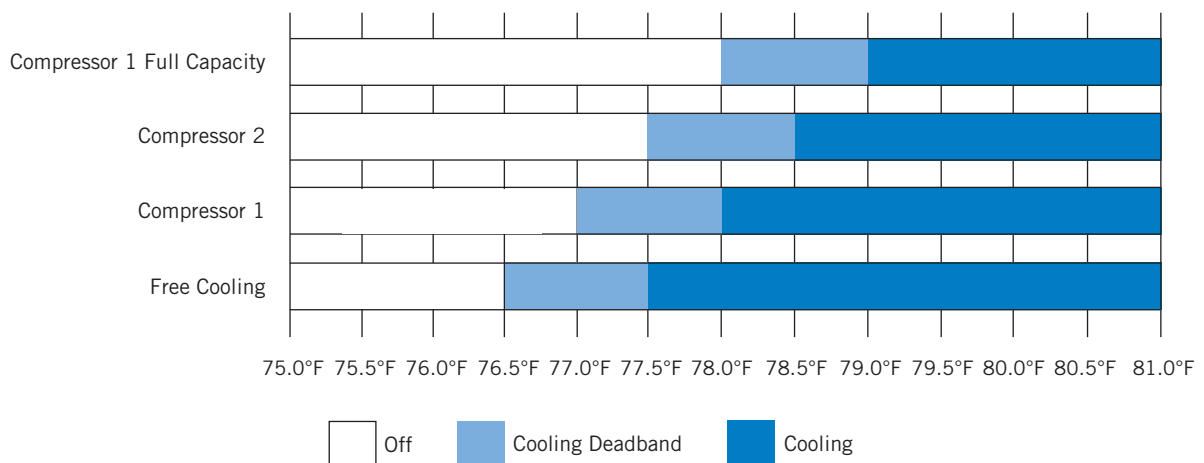
### LC6000 Control

When the unit is connected to a LC6000 supervisory controller, the cooling and heating stages will be controlled by the LC6000. For more information on LC6000 staging, see latest version of LC6000 Service Instructions 2100-669.

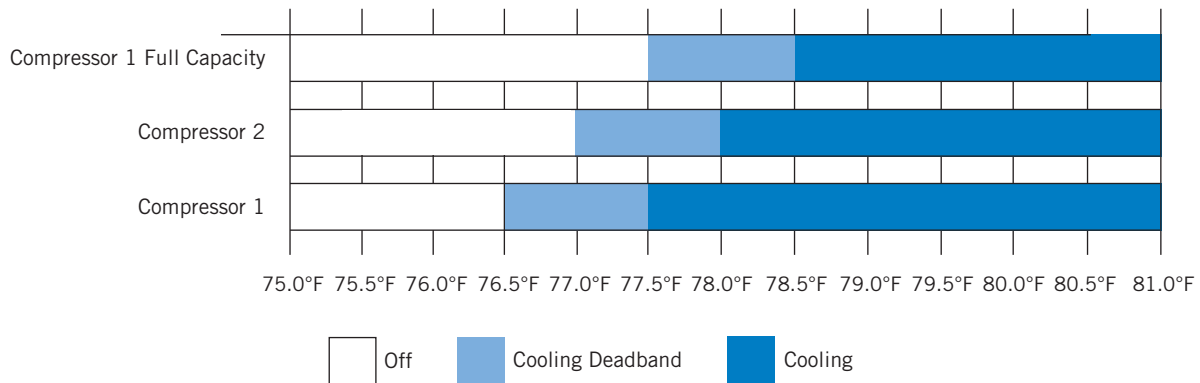
### Cooling

Units equipped with an economizer will use one stage of freecooling and up to three stages of mechanical cooling to cool the space. The economizer will always be prioritized first. When an economizer is not installed or the conditions outside are not desirable for cooling, the unit will use up to three stages of mechanical cooling to cool the space. All 400V units use a single capacity compressor for circuit 1, reducing the mechanical cooling stages to two. The units will use the staging differentials in Figure 17 and Figure 18 (page 16) by default. These differentials can be configured on screen **Cool Staging B3**.

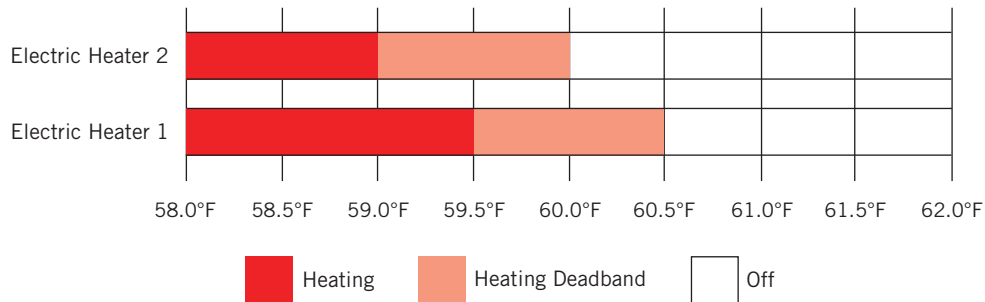
**FIGURE 17**  
**Cooling (with Economizer)**



**FIGURE 18**  
Cooling (without Economizer)



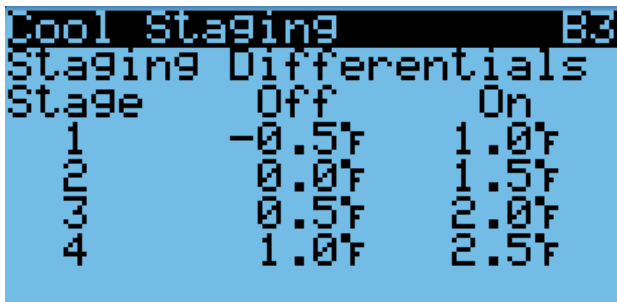
**FIGURE 19**  
Heating



To view or adjust the cooling differentials:

1. Press MENU key to go to the Main Menu screen.
2. Press UP or DOWN keys and ENTER key to enter ENGINEER password 9254.
3. Press UP or DOWN keys to scroll to **Adv. Sys. Config**; press ENTER key.
4. Press UP or DOWN keys to scroll to **Cool Staging B3** (see Figure 20).
5. Press ENTER key to advance the cursor to the desired value.
6. Press UP or DOWN keys to change values.

**FIGURE 20**  
Adjusting Cooling Differentials



**Heating**

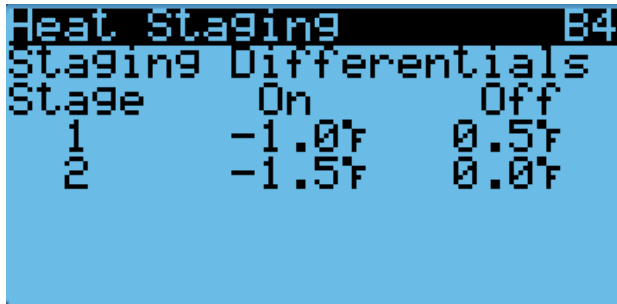
The unit will use up to 2 stages of electric heat to heat the space (see Figure 19). Electric heat is available as an option and the heating capacity will determine the number of stages (see **Electric Heat Option** on page 39).

To view or adjust the heating differentials:

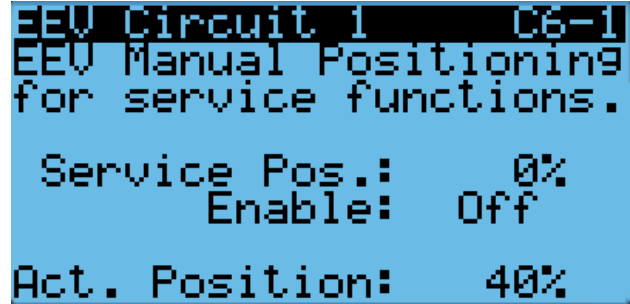
1. Press MENU key to go to the Main Menu screen.
2. Press UP or DOWN keys and ENTER key to enter ENGINEER password 9254.
3. Press UP or DOWN keys to scroll to **Adv. Sys. Config**; press ENTER key.
4. Press UP or DOWN keys to scroll to **Heat Staging B4** (see Figure 21).
5. Press ENTER key to advance the cursor to the desired value.
6. Press UP or DOWN keys to change values.



**FIGURE 21**  
Adjusting Heating Differentials



**FIGURE 22**  
Overriding EEV Output



## Electronic Expansion Valve (EEV)

### EEV Components

#### Electronic Expansion Valve

The electronic expansion valve is a stepper motor that is controlled with a step output from the controller. The valve is capable of 480 steps represented by a 0-100% signal on the controller. The motor drives a needle valve that regulates the flow of refrigerant.

#### EEV Instructions for Vacuum, Reclaim, Charge Unit

The electronic expansion valve moves to the 40% open position when the unit is not actively cooling. The valve may need to be manually positioned for service or troubleshooting. The valve can be positioned by using a menu override. Once the valve is placed into override, the EEV will remain in the Service Position Override for 5 minutes.

To manually override the valve:

1. Turn the unit off using the TEC-EYE. See **Unit On/Off** on page 13 for instructions on how to turn unit off using the TEC-EYE.
2. Press MENU key to go to the Main Menu screen.
3. Press UP or DOWN keys and ENTER key to enter TECHNICIAN password 1313.
4. Press UP or DOWN keys to scroll to **I/O Config**; press ENTER key.
5. Press UP or DOWN keys to scroll to **Manual EEV**; press ENTER key.
6. Press UP or DOWN keys to scroll to **EEV Circuit 1 C6-1** or **EEV Circuit 2 C6-2**.
7. Press ENTER key to scroll to **Service Pos** (see Figure 22).
8. Press UP or DOWN keys to adjust to the desired value.
9. Press ENTER key to scroll to **Enable**.
10. Press UP or DOWN key to change **Off** to **On**.
11. Press ENTER key to save.

After the service or troubleshooting is completed, use TEC-EYE to disable the EEV manual positioning override

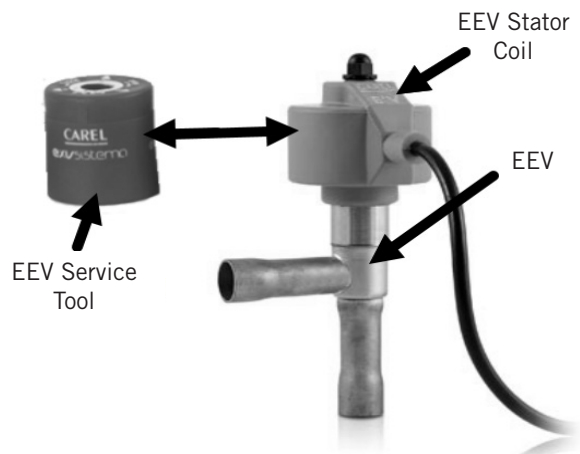
and turn unit back on. If EEV manual position override is not turned off, once 5 minutes has elapsed from the time the valve was placed into override, the override will expire and the valve will return to normal operation.

The valve can also be opened or closed using the EEV service tool (Bard Part # 2151-021). This magnetic EEV service tool (shown in Figure 23) is used to manually open the EEV. To do this, remove the EEV stator coil (red color with retaining nut on top), slide the magnetic tool over the shaft where the stator was removed and turn in a clockwise direction to open the valve to the full open position (directional arrows are provided on the tool). Opening the valve to the full open position will aid in the refrigerant reclamation and evacuation processes.

With the stator removed, the resistance should be 40 ohms +/- 10%. There are two sets of three wires that will have this resistance.


After removing the EEV service tool, reapply the EEV stator coil and retaining nut. Upon powering the unit back up, the control board will automatically drive the EEV back to the fully shut position, and then back to the 40% open position prior to starting the compressor back up. Once the compressor starts, the control board will again modulate the EEV position to control the system superheat.

**FIGURE 23**  
Electronic Expansion Valve (EEV) and Service Tool



## System Pressures

To view system pressure and temperatures during this process:

1. From the Status screen, press UP or DOWN key until Quick Menu displays Unit Information icon (  ). Press ENTER key.
2. Press UP or DOWN keys to scroll to **A/C Circuit 1 Info** and **A/C Circuit 2 Info** screens (see Figure 8 on page 10).

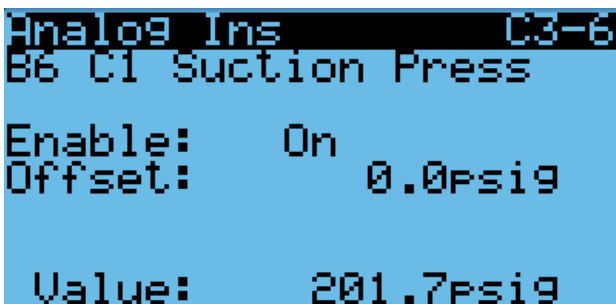
## Suction Pressure Transducer

The unit has pressure transducers installed on the suction line between the evaporator coil and compressor (one on refrigerant circuit 1 and one on refrigerant circuit 2). The transducer is used for system monitoring of suction system pressures. The transducer is used with the suction temperature sensor to provide a real time superheat calculation that determines the EEV position.

This transducer reading can be verified and adjusted by:

1. Press MENU key to go to the Main Menu screen.
2. Press UP or DOWN keys and ENTER key to enter TECHNICIAN password 1313.
3. Press UP or DOWN keys to scroll to **I/O Config**; press ENTER key.
4. Press UP or DOWN keys to scroll to **Analog Inputs**; press ENTER key.
5. Press UP or DOWN keys to scroll to **Analog Ins C3-6** (for circuit 1) or **Analog Ins C3-8** (for circuit 2).
6. Verify the measurement displayed on screen is accurate (see Figure 24).
7. If the measurement needs to be adjusted, apply an offset value by pressing ENTER to scroll to **Offset**.
8. Press UP or DOWN keys to adjust the offset.
9. The update will not take effect until the cursor is moved out of the **Offset** parameter.
10. Once adjusted, press the ESCAPE key several times to return to Main Menu screen.

**FIGURE 24**  
Adjusting Suction Sensor/Transducer  
Pressure Values



## Troubleshooting the Suction Pressure Transducer

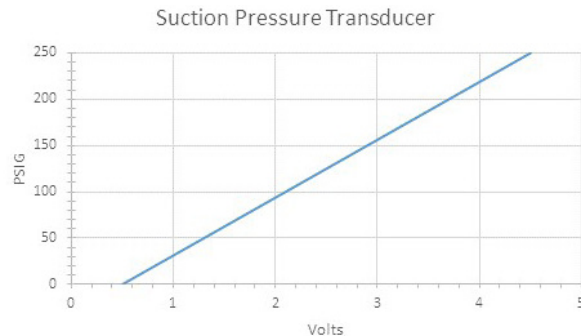
0-250 psig  
-5v Nominal, .5 – 4.5v Actual  
4v/250 psig = .016 volts per 1 psig

*Example:* 125 psig x .016 + .5 volts = 2.5 volts

Formula for Tech:

Measured Pressure x .016 + Voltage Offset = Expected Transducer Signal Voltage (see Figure 25).

**FIGURE 25**  
Voltage to Pressure: Suction Pressure Transducer



## Suction Pressure Alarm

When the suction pressure transducer value is measured out of range (0-250 PSIG) and the compressor has been operating for longer than 1 minute (verified by discharge pressure transducer), the controller will generate a sensor failure alarm to indicate the sensor is not working properly.

This alarm cannot be adjusted.

## Suction Temperature Sensor

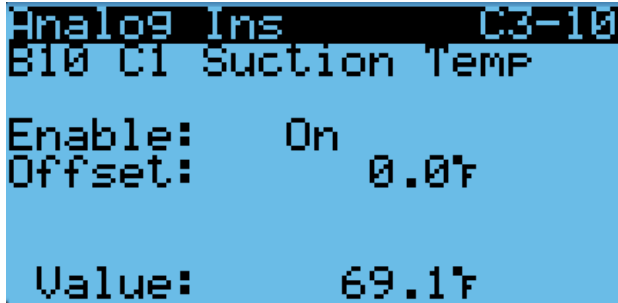
The suction temperature sensor is used to calculate superheat. The EEV uses this value to control the EEV. The temperature is measured with a 10k ohm NTC thermistor.

The suction temperature sensor measurement can be verified and adjusted by:

1. Press MENU key to go to the Main Menu screen.
2. Press UP or DOWN keys and ENTER key to enter TECHNICIAN password 1313.
3. Press UP or DOWN keys to scroll to **I/O Config**; press ENTER key.
4. Press UP or DOWN keys to scroll to **Analog Inputs**; press ENTER key.
5. Press UP or DOWN keys to scroll to **Analog Ins C3-10** (for circuit 1) or **Analog Ins C3-11** (for circuit 2).
6. Verify the measurement displayed on screen is accurate (see Figure 26).
7. If the measurement needs to be adjusted, apply an offset value by pressing ENTER to scroll to **Offset**.

8. Press UP or DOWN keys to adjust the offset.
9. The update will not take effect until the cursor is moved out of the **Offset** parameter.

**FIGURE 26**  
Adjusting Suction Temperature Sensor Values



#### Suction Temperature Sensor Alarm

When the suction temperature sensor value is out of range (-41.0 to 303.0°F), the controller will generate a sensor failure alarm to indicate the sensor is not working properly.

This alarm cannot be adjusted.

#### EEV Operation

##### EEV Superheat Control

The electronic expansion valve (EEV) will open or close to maintain the superheat setpoint while the compressor is running (see Table 5). When the compressor is not running, the valve will close to the 40% open default position.

**TABLE 5**  
Unit Specific Superheat Setpoints

Unit	Superheat
W180B	12°F

Low superheat protection will be active once the superheat value is at or below 5°F. At this point, the control will aggressively close the valve so that superheat is maintained.

#### Additional EEV Alarms

##### Low Superheat Alarm

This alarm will become active when the calculated superheat goes below 5°F. This alarm will clear itself when the condition is no longer present.

This alarm cannot be adjusted.

## Indoor Airflow

### Indoor Airflow Components

#### Blower

The unit is equipped with a blower that is driven by an electronically commutated motor (ECM). The blower is controlled by a 0-100% signal through Modbus communication. The motor controller converts this signal to a PWM signal. The blower uses a 17.7" (450 mm) diameter wheel and operates up to 2300 rpm.

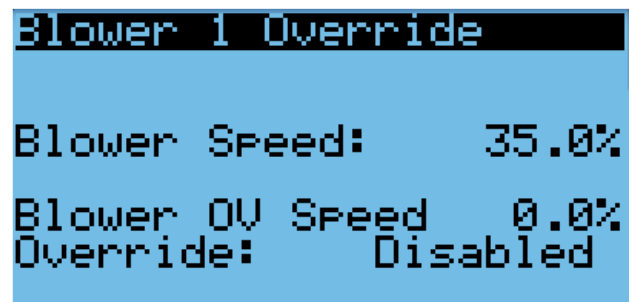
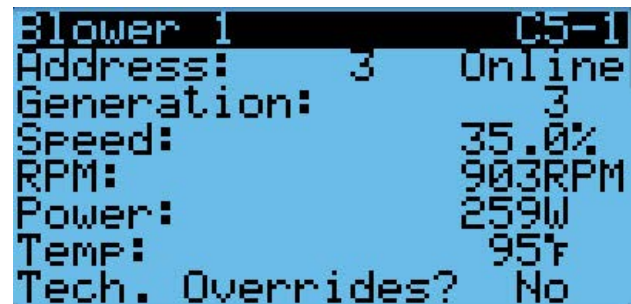
The blower output can be put into an override mode for verification or troubleshooting.

To put the blower into override:

1. Press MENU key to go to the Main Menu screen.
2. Press UP or DOWN keys and ENTER key to enter TECHNICIAN password 1313.
3. Press UP or DOWN keys to scroll to **I/O Config**; press ENTER key.
4. Press UP or DOWN keys to scroll to **Fans / Blowers**; press ENTER key.
5. Press UP or DOWN keys to scroll to **Blower 1 C5-1** or **Blower 2 C5-2**.
6. Press ENTER key to scroll to Blower **Overrides?** (see Figure 27).
7. Press UP or DOWN key to change **No** to **Go**. The override will begin and the screen will change to the override screen (see Figure 27).

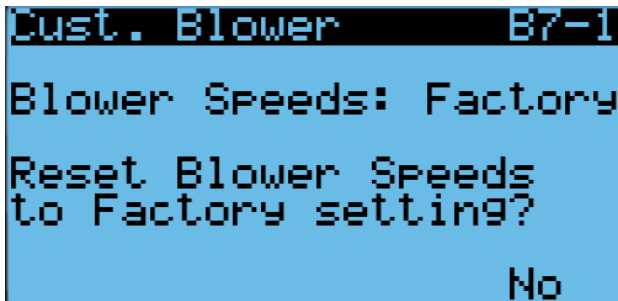
The override will last for 5 minutes or until the **Blower Overrides** parameter is set to **No** again.

**FIGURE 27**  
Putting Blower Output into Override Mode



The blower output can essentially be placed into a permanent override that can only be turned off and/or reset to factory blower speeds by the user. This override will only allow for the blower speed to be increased above the rated airflow for a given mode of operation. This allows the airflow to be tailored to special situations or airflow needs. Modifying the blower speeds and enabling this override will affect system performance, but by limiting the adjustment to only allow for an increase of the rated airflow speeds, the built-in safeties will not be compromised. The **Cust. Blower B7-1** screen (see Figure 28) will display **Factory** if the blower speeds have not been modified and are in the Factory programmed state. Once any speed has been modified, **Custom** will be displayed indicating that the factory programmed speeds are not being used. A reset is available to revert all changes back to the Factory speeds, if desired. Any changes made to the blower output will then be reflected in the Info menu accessed from the Main Menu screen when the blower is active or from the **Fans / Blowers** info screens.

**FIGURE 28**  
Verifying Blower Speeds State



**Alarm Speeds B7-6** screen (see Figure 29) will allow for Emergency Vent (emergency vent operation only available if connected to an LC6000) and Freeze speeds to be adjusted down to Cool 2 Nominal airflow speed. If the system were to operate in either of these modes with a ducted system, there could be extremely high static pressure put on the duct system as a result. See Table 9 on page 24 for blower speeds.

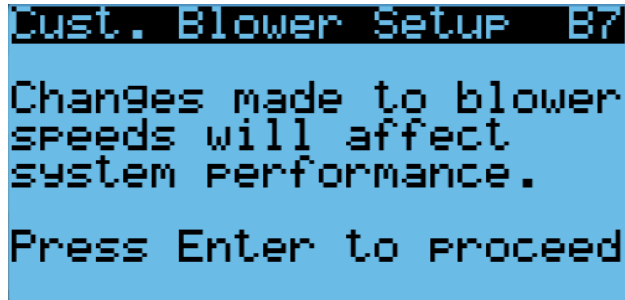
**FIGURE 29**  
Adjusting Emergency Vent and Freeze Speeds



To put the blower into Custom Blower mode:

1. Press Menu key to go to the Main Menu screen.
2. Press UP or DOWN keys and ENTER key to enter TECHNICIAN password 1313.
3. Press UP or DOWN keys to scroll to **Advanced System Config**; press ENTER key.
4. Press UP or DOWN keys to scroll to **Cust. Blower Setup B7**; press ENTER (see Figure 30).

**FIGURE 30**  
Putting Blower into Custom Blower Mode



5. Press UP or DOWN keys to toggle through to the next screens from **B7-1** (see Figure 31). If a Factory reset of the blower speeds is desired, press the ENTER key then press UP or DOWN keys to toggle **No** to **Yes** at the bottom of the screen; press ENTER.
6. Once screens **Cust. Blower B7-2** to **Alarm Speeds B7-6** are displayed, any one or all of the speeds listed can be changed from the Factory blower output displayed on the screens. Once any one of the speeds is manipulated, screen **Cust. Blower B7-1** will display **Custom** instead of **Factory** to indicate a change has been made.

**FIGURE 31**  
Custom Blower Screens

Cust. Blower		B7-2
Blower Only:	35.0%	
Free Cooling:	48.0%	
Cool 1 BC:	20.2%	
Cool 1 Nominal:	30.0%	
Cool 1 HS:	37.0%	
Cool 2 BC:	34.6%	
Cool 2 Nominal:	48.0%	

Cust. Blower		B7-3
Cool 2 HS:	53.0%	
Cool 2 BC:	34.6%	
Cool 2 Nominal:	48.0%	
Cool 2 HS:	53.0%	
Heat Stage 1:	48.0%	
Heat Stage 2:	48.0%	
Dehum:	34.6%	

Cust. Blower 2		B7-4
Blower Only:	35.0%	
Free Cooling:	48.0%	
Cool 1 BC:	20.2%	
Cool 1 Nominal:	30.0%	
Cool 1 HS:	37.0%	
Cool 2 BC:	34.6%	
Cool 2 Nom:	48.0%	

Cust. Blower 2		B7-5
Cool 2 HS:	53.0%	
Cool 2 BC:	34.6%	
Cool 2 Nominal:	48.0%	
Cool 2 HS:	53.0%	
Heat Stage 1:	48.0%	
Heat Stage 2:	48.0%	
Dehum:	34.6%	

**TABLE 6**  
Rated Airflow

	Nominal Rated CFM		Nominal Rated ESP
	High	Low	
W180B	5400	3280	0.35

**TABLE 7**  
Indoor Blower Performance

	ESP (Inch H <sub>2</sub> O)	Dry Coil	Wet Coil
W180B	0.35	8190	N/A

**TABLE 8**  
Maximum ESP of Operation  
Electric Heat Only

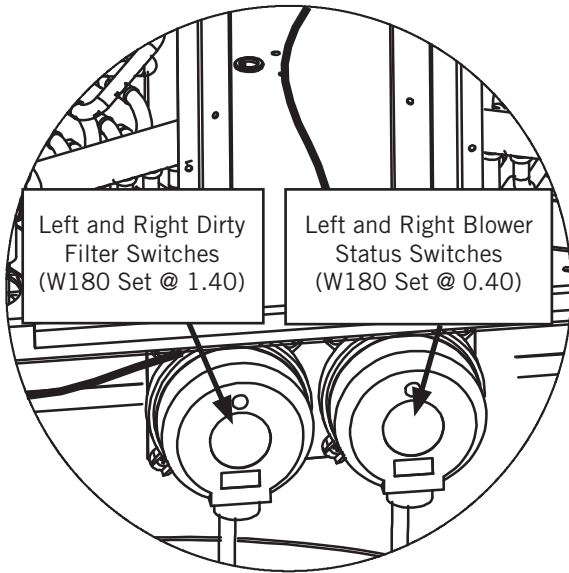
Model	Static Pressure ("WC)*
-N0Z	1.00"
-N09	1.00"
-N18	1.00"
-N36	1.00"
-Q0Z	1.00"
-Q09	1.00"
-Q18	1.00"
-Q36	1.00"
-S0Z	1.00"
-S09	1.00"
-S18	1.00"
-S36	1.00"
-T0Z	1.00"
-T09	1.00"
-T18	1.00"
-T36	1.00"

\* Unit is rated for free blow non-ducted operation with SG-15W Supply Grille and RG-15W Return Grille.

**Blower Status Switch**

The unit is equipped with a differential pressure airflow switch to monitor the blower (see Figure 32 on page 22). If the blower is turned on and the switch doesn't open to indicate there is differential pressure between the inlet and outlet of the blower, an alarm will be generated. For switch settings, see Figure 32.

**FIGURE 32**  
**Dirty Filter Switch and Blower Status Switch**



Differential airflow status can be viewed by:

1. Press MENU key to go to the Main Menu screen.
2. Press UP or DOWN keys and ENTER key to enter TECHNICIAN password 1313.
3. Press UP or DOWN keys to scroll to **I/O Config**; press ENTER key.
4. Press UP or DOWN keys to scroll to **Digital Inputs C1-1**; press ENTER key.
5. Reference **Airflw 1** row and **Val** column (see Figure 33).

**FIGURE 33**  
**Verifying Differential Airflow Status**

Digital Ins C1-1			
Channel	En	Dir	Val
Disable	No	N/C	Off
CCM1	Yes	N/O	Off
CCM2	Yes	N/O	Off
Airflw 1	Yes	N/C	On
Airflw 2	Yes	N/C	On
Filter 1	Yes	N/C	Off

Digital Ins C1-2			
Channel	En	Dir	Val
Filter 2	Yes	N/C	Off
Panel Sw	Yes	N/C	Off
Damper 1	Yes	N/O	On
Damper 2	Yes	N/O	On
Damper 3	Yes	N/O	On
Damper 4	Yes	N/O	On

### Blower Status Alarm

When the blower is on for 45 seconds and no airflow is detected by the airflow switch, the compressor and heating operations will be disabled. The system will wait 5 minutes before trying again. After three consecutive no airflow events, the system will generate an alarm and lockout requiring a user reset.

### Filters

The filters can be serviced by opening the "hinged" front access panel and locking it into position. They sit upon a removal tray by pushing or pulling them in place. This also improves access to back filters without having to reach inside the unit. There are six (6) MERV 8 filters (three per coil), each measuring 16" x 25" x 2".

### Dirty Filter Switch

These units are equipped with a differential pressure switch to indicate when the filter(s) needs to be replaced (see Figure 32). The dirty filter switch measures the pressure difference across the filter through silicone tubing routed to the blower and evaporator areas of the unit.

The switch circuit consists of a *normally closed* filter pressure switch. The switch will open when the pressure differential goes above the setting indicated on the dial. When the pressure difference returns below the setting on the dial, the switch will close.

Adjustment of dirty filter switch may be necessary to ensure proper operation. See Figure 34 to aid in setting the filter switch to operate at different percentages of filter blockage.

Filter switch status can be viewed by:

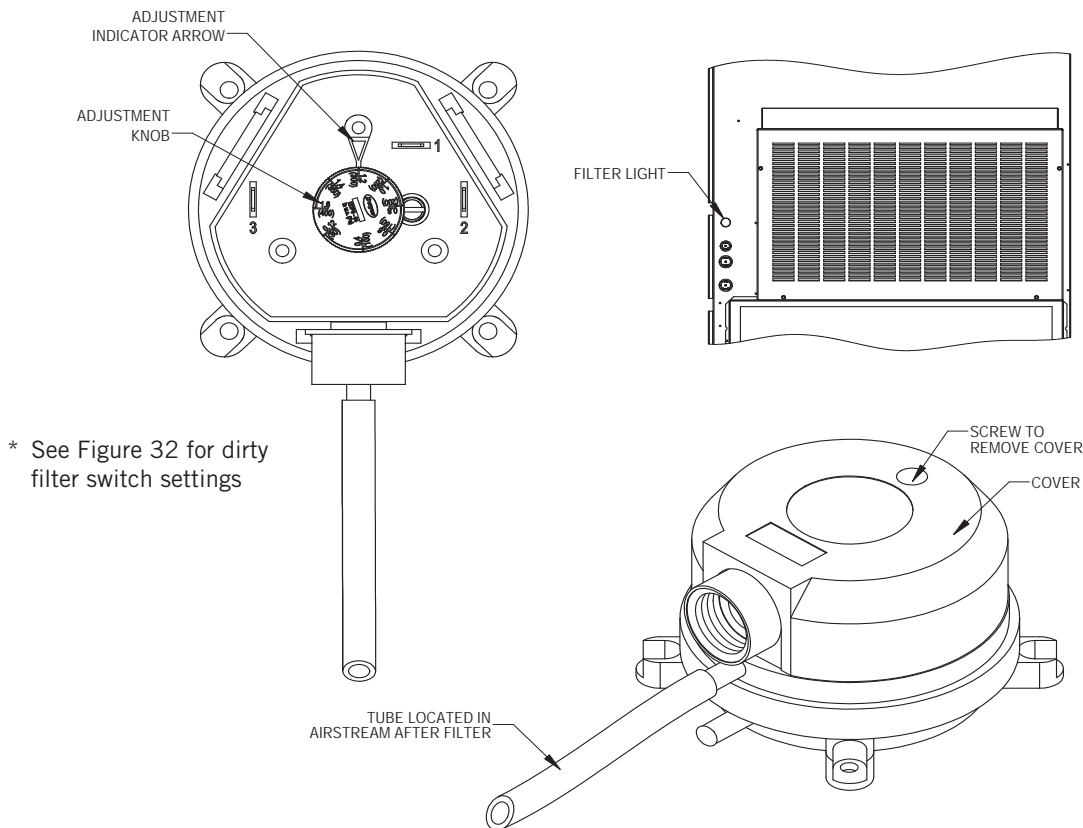
1. Press MENU key to go to the Main Menu screen.
2. Press UP or DOWN keys and ENTER key to enter TECHNICIAN password 1313.
3. Press UP or DOWN keys to scroll to **I/O Config**; press ENTER key.
4. Press UP or DOWN keys to scroll to **Digital Inputs C1-1** (Filter 1) or **Digital Inputs C1-2** (Filter 2); press ENTER key.
5. Reference **Filter 1** or **Filter 2** row and **Val** column (see Figure 33).

### Dirty Filter Alarm

The wall-mount unit is equipped with a differential pressure switch input to the controller. When the switch indicates a dirty filter, the controller will generate an alarm. The alarm will latch once triggered requiring a technician to acknowledge the alarm after replacing filters. Additionally, an indicator light will be turned on with the alarm and turned off when the alarm clears.

The threshold of this alarm is adjusted by changing the settings on the switch (see Figure 34).

**FIGURE 34**  
**Dirty Filter Switch and Filter Indicator Light**



\* See Figure 32 for dirty filter switch settings

### Filter Indicator Light

The wall-mount unit is equipped with a 24V indicator light mounted on side of unit that displays the current status of the filter (see Figure 34). When the light is on, the filter needs to be replaced. Once the filter(s) has been changed and the alarm has been cleared, the indicator light will turn off.

To view the status of the output:

1. Press MENU key to go to the Main Menu screen.
2. Press UP or DOWN keys and ENTER key to enter TECHNICIAN password 1313.
3. Press UP or DOWN keys to scroll to **I/O Config**; press ENTER key.
4. Press UP or DOWN keys to scroll to **Digital Outputs**; press ENTER key.
5. Press UP or DOWN keys to scroll to **Digital Outputs C2-1**.
6. The status is displayed next to **Filter Light** (see Figure 35).

**FIGURE 35**  
**Verifying Filter Light Status**

Digital Outputs C2-1	
Output Status	
Compressor 1:	Off
Comp 1 Full:	Off
Compressor 2:	Off
Elect. Heat 1:	Off
Elect. Heat 2:	Off
Filter Light:	Off

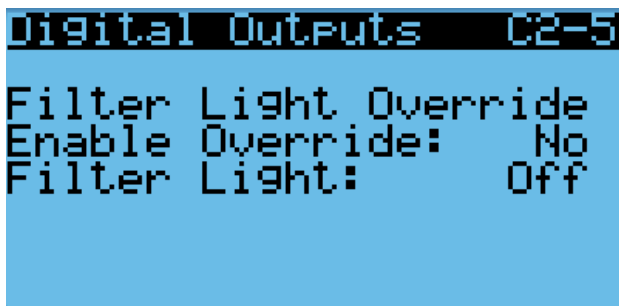
The filter light output can be put into override to aid in troubleshooting. The override will only stay active for 5 minutes.

To override the filter light output:

1. Press MENU key to go to the Main Menu screen.
2. Press UP or DOWN keys and ENTER key to enter TECHNICIAN password 1313.
3. Press UP or DOWN keys to scroll to **I/O Config**; press ENTER key.
4. Press UP or DOWN keys to scroll to **Digital Outputs**; press ENTER key.

5. Press UP or DOWN keys to scroll to **Digital Outputs C2-5**.
6. Press ENTER key to scroll to **Enable Override** (see Figure 36).
7. Press UP or DOWN key to change value to **Yes**.
8. Press ENTER key to scroll to **Filter Light**.
9. Press UP or DOWN key to change value to **On** or **Off**.

**FIGURE 36**  
**Overriding Filter Light Output**



### **Indoor Airflow Operation**

#### **Blower Speed Control**

The blower is capable of changing speeds to best match the requirements of the system depending on which mode the system is in.

The unit will automatically adjust its blower speed based on the mode and number of stages active. In addition to the nominal speeds for each cooling stage, the controller has the option to enable high sensible operation or Balanced Climate™ operation (see Table 9).

#### **Freeze Condition Operation**

A freeze condition will occur when the Saturated Evap temp falls below 28°, triggering an Active Freeze alarm and will then run the blower at the listed Freeze Condition speed for 5 minutes once the alarm has been triggered.

#### **High Sensible Operation**

In high sensible operation, the blower speed will be raised for each stage of cooling to increase the sensible cooling of the equipment. With this option enabled, the higher speeds will be used during compressor operation unless passive or active dehumidification modes are operating.

#### **Balanced Climate Operation**

In Balanced Climate operation, the blower speed will be lowered for each stage of cooling to improve the moisture removal capabilities of the equipment. With this option enabled, the lower speeds will be used during compressor operation when the indoor humidity is above the passive dehumidification setpoint.

**NOTE:** Blower speeds may revert back to nominal speeds during active dehumidification if electric reheat is used.

**TABLE 9**  
**W180 Blower Speed Settings\***

Mode		Blower %	
		230V	460V
Blower Only		35.0	35.0
Free Cooling		48.0	43.0
Cooling Stage 1	Balanced Climate	20.2	19.3
	Nominal	30.0	26.2
	High Sensible	37.0	29.0
Cooling Stages 2 and 3	Balanced Climate	34.6	30.5
	Nominal	48.0	43.0
	High Sensible	53.0	46.0
Heating Stage 1		48.0	43.0
Heating Stage 2		48.0	43.0
Dehumidification		34.6	30.5
Emergency Ventilation		100.0	100.0
Freeze Condition		80.0	80.0

\* Blower position percentages are communicated through Modbus and cannot be verified with meter.

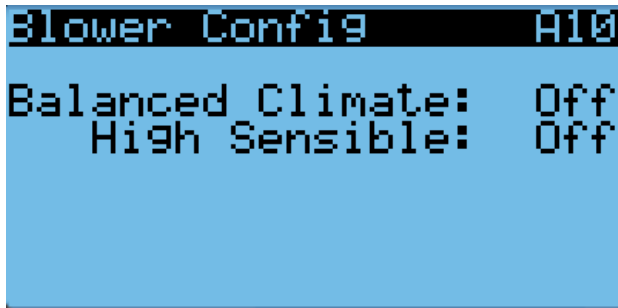
To enable or disable either high sensible operation or Balanced Climate operation:

1. Press MENU key to access the Main Menu screen.
2. Press UP or DOWN keys and ENTER key to enter USER password 2000.
3. Press UP or DOWN keys to scroll to **Sys Config**; press ENTER key.
4. Press UP or DOWN keys to scroll to **Blower Config A10** screen.
5. Press ENTER key to scroll to **Balanced Climate** or **High Sensible** parameter (see Figure 37).
6. Press UP or DOWN key to change value from **Off** to **On** or **On** to **Off**.

The unit will automatically switch to the required speed for each mode. For more information on the high sensible command from LC, please see LC6000 Service Instructions 2100-669.



**FIGURE 37**  
Enabling/Disabling High Sensible Operation or  
Balanced Climate Operation



### Additional Indoor Airflow Alarms

#### Supply Air Temperature Alarm

When the supply air temperature sensor value is out of range (-41.0 to 303.0°F), the controller will generate a sensor failure alarm to indicate the sensor is not working properly.

This alarm is fixed and cannot be adjusted.

### Condenser Fan

#### Condenser Fan Components

##### Condenser Fan

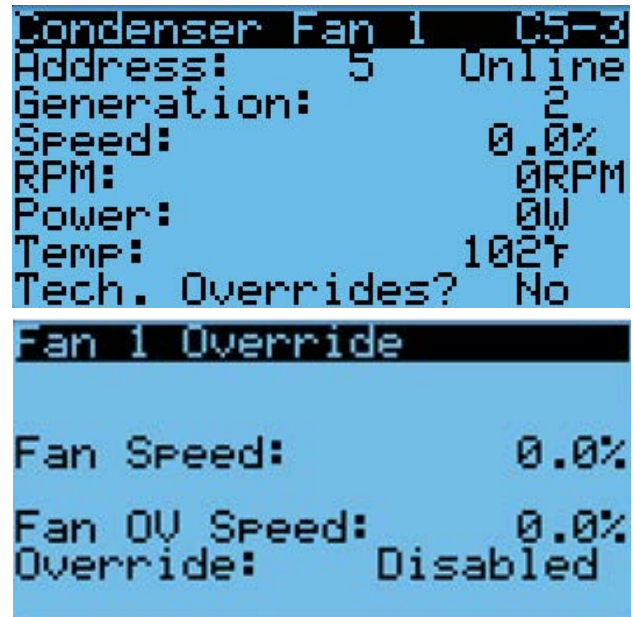
The unit is equipped with a condenser fan that is driven by an electronically commutated motor (ECM). This fan is controlled by a 0-100% command using Modbus serial communication. The fan operates between 100-1200 rpm.

To enable fan override:

1. Press MENU key to go to the Main Menu screen.
2. Press UP or DOWN keys and ENTER key to enter TECHNICIAN password 1313.
3. Press UP or DOWN keys to scroll to **I/O Config**; press ENTER key.
4. Press UP or DOWN keys to scroll to **Fans / Blowers**; press ENTER key.
5. Press UP or DOWN keys to scroll to **Condenser Fan 1 C5-3** or **Condenser Fan 2 C5-4** (see Figure 38).
6. Press ENTER key to scroll to the **Fan Overrides?**
7. Press UP or DOWN keys to change the value from **No** to **Go**. The override will begin and the screen will change to the override screen (see Figure 38).

The override will last for 5 minutes or until the **Fan Overrides** parameter is set to **No** again.

**FIGURE 38**  
Enabling Fan Override



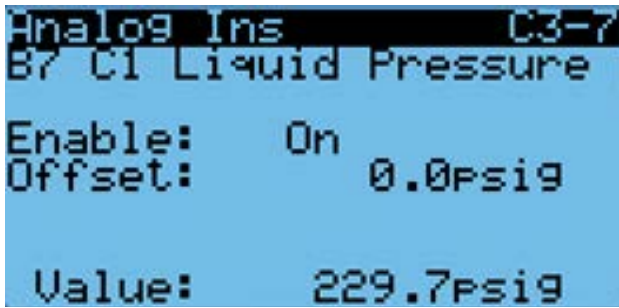
#### Liquid Pressure Sensor

The unit has a pressure transducer installed on the liquid line between the condenser and electronic expansion valve (EEV). The transducer is used for condenser fan speed control and for monitoring of system operation. The liquid line transducer is also referred to as the discharge or liquid pressure sensor.

The discharge/liquid pressure sensor input can be verified and adjusted by:

1. Press MENU key to go to the Main Menu screen.
2. Press UP or DOWN keys and ENTER key to enter TECHNICIAN password 1313.
3. Press UP or DOWN keys to scroll to **I/O Config**; press ENTER key.
4. Press UP or DOWN keys to scroll to **Analog Inputs**; press ENTER key.
5. Press UP or DOWN keys to scroll to **Analog Ins C3-7** (for circuit 1) or **Analog Ins C3-9** (for circuit 2).
6. Verify the measurement displayed on screen is accurate (see Figure 39 on page 26).
7. If the measurement needs to be adjusted, apply an offset value by pressing the ENTER key to scroll to **Offset**.
8. Press UP or DOWN keys to adjust the offset. The update will not take effect until the cursor is moved out of the offset parameter.
9. Once adjusted, the ESCAPE key several times to return to Main Menu screen.

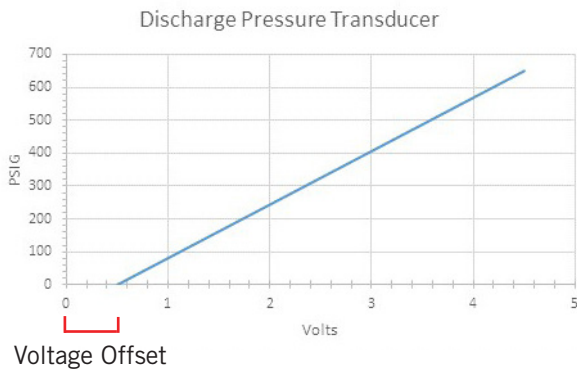
**FIGURE 39**  
**Adjusting Discharge/Liquid Transducer**  
**Pressure Values**



**Troubleshooting the Discharge/Liquid Pressure Transducer**

0-650 psig  
 .5 to 4.5v  
 $4.5 - .5 + 4 \text{ volt range} / 650 \text{ psig} = .00615 \text{ volts per 1 psig}$   
*Example:*  $325 \text{ psig} \times .00615 + .5 \text{ v} = 2.5 \text{ volts}$   
 Formula for Tech:  
 Measured Pressure x .00615 + Voltage Offset =  
 Expected Transducer Signal Voltage (see Figure 40).

**FIGURE 40**  
**Voltage to Pressure:**  
**Discharge/Liquid Pressure Transducer**



**Discharge/Liquid Pressure Transducer Alarm**

When the discharge pressure sensor value is out of range (0-650 PSIG), the controller will generate a sensor failure alarm to indicate the sensor is not working properly.

This alarm is fixed and cannot be adjusted.

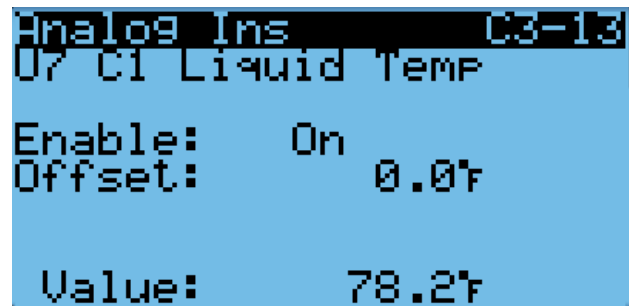
**Liquid Temperature Sensor**

The unit is equipped with a liquid line temperature sensor to monitor the temperature of the liquid refrigerant leaving the condenser and entering the EEV. The temperature is measured with a 10k ohm NTC thermistor.

The liquid temperature sensor can be verified and adjusted by:

1. Press MENU key to go to the Main Menu screen.
2. Press UP or DOWN keys and ENTER key to enter TECHNICIAN password 1313.
3. Press UP or DOWN keys to scroll to **I/O Config**; press ENTER key.
4. Press UP or DOWN keys to scroll to **Analog Inputs**; press ENTER key.
5. Press UP or DOWN keys to scroll to **Analog Ins C3-13** (for circuit 1) or **Analog Ins C3-15** (for circuit 2).
6. Reference the **Value** to verify the temperature (see Figure 41).
7. If an offset needs to be applied, press ENTER key to scroll to **Offset**.
8. Press UP or DOWN keys to change the offset to desired value.
9. Press ENTER key to save.
10. Press ESCAPE key several times to return to Main Menu screen.

**FIGURE 41**  
**Adjusting Discharge/Liquid Temperature Input**



**Outdoor Temperature Sensor**

The unit is equipped with a combination outdoor temperature and humidity sensor. The temperature is measured with a 10k ohm NTC thermistor. See page 34 for more information.

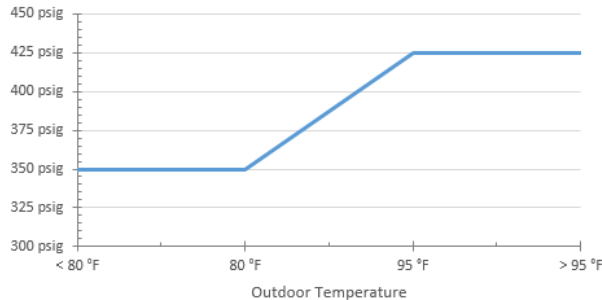
**Condenser Fan Operation**

**Condenser Fan Speed Control**

The fan will speed up or slow down to attempt to maintain a discharge/liquid pressure setpoint. The discharge/liquid pressure setpoint will vary based on the outdoor ambient conditions (see Figure 42). If the outdoor temperature sensor fails, or is disabled, the discharge/liquid pressure setpoint will be set to a nominal value of 415 psig. Because the control is dependent on the discharge pressure sensor, the controller will alter its operation if the sensor is not

enabled or failed. When the liquid pressure transducer is not enabled or considered failed by the controller, a nominal speed will be used during a compressor call (see Table 10).

**FIGURE 42**  
**Condenser Fan Discharge/Liquid Pressure Setpoint**



**TABLE 10**  
**Condenser Fan Nominal Speed**

Unit	Outdoor Temperature	Discharge Pressure Setpoint	Nominal Discharge/Liquid Pressure Setpoint	Nominal Condenser Fan Speed
W180	< 80°F	350 psig	425 psig	58%
	80°F – 95°F	350 – 425 psig		
	> 95°F	425 psig		

## Compressor

### Compressor Components

#### Compressor

##### *Three Phase Scroll Compressor Start Up Information*

Scroll compressors, like several other types of compressors, will only compress in one rotational direction. Direction of rotation is not an issue with single phase compressors since they will always start and run in the proper direction.

However, three phase compressors will rotate in either direction depending upon phasing of the power. Since there is a 50-50 chance of connecting power in such a way as to cause rotation in the reverse direction, verification of proper rotation must be made. Verification of proper rotation direction is made by observing that suction pressure drops and discharge pressure rises when the compressor is energized. Reverse rotation also results in an elevated sound level over that with correct rotation, as well as substantially reduced current draw compared to tabulated values.

Verification of **proper rotation** must be made at the time the equipment is put into service. If improper rotation is corrected at this time, there will be no negative impact on the durability of the compressor. However, reverse operation for over 1 hour may have a negative impact on the bearing due to oil pump out.

**NOTE:** *If compressor is allowed to run in reverse rotation for an extended period of time, the compressor's internal protector will trip.*

All three phase compressors are wired identically internally. As a result, once the correct phasing is determined for a specific system or installation, connecting properly phased power leads to the same Fusite terminal should maintain proper rotation direction.

The direction of rotation of the compressor may be changed by reversing any two line connections to the wall-mount unit.

#### Compressor Control Module (CCM)

Delay-on-Make Timer

Short Cycle Protection/Delay-on-Break

Test Mode

High Pressure Detection

Brownout Protection with Adjustment

The LPC terminals are jumpered in this application. Instead, the low pressure transducer is used for low pressure monitoring.

Each compressor uses an independent CCM.

##### **Delay-on-Make Timer**

In the event of power loss, a delay-on-make timer is included to be able to delay startup of the compressor. This is desired when more than one unit is on a structure so that all of the units do not start at the same time which could happen after a power loss or building shutdown. The delay-on-make time period is 2 minutes plus 10% of the delay-on-break time period. To ensure that all of the units do not start at the same time, adjust the delay-on-break timer on each unit to a slightly different delay time.

##### **Short Cycle Protection/Delay-on-Break**

An anti-short cycle timer is included to prevent short cycling the compressor. This is adjustable from 30 seconds to 5 minutes via the adjustment knob (see Figure 43 on page 28). Once a compressor call is lost, the time period must expire before a new call will be initiated.

10% of this time is also considered on the delay-on-make timer (see **Delay-on-Make Timer**).

##### **High Pressure Detection**

High pressure switch monitoring allows for a lockout condition in a situation where the switch is open. If the high pressure switch opens, the CCM will de-energize the compressor. If the switch closes, it will then restart the compressor after the delay-on-break setting has expired on the device. If the switch trips again during

the same Y call, the compressor will be de-energized. The ALR terminal will be energized, signaling the unit control board that a high pressure event has occurred (see **Refrigerant High Pressure Alarm**).

**Test Mode**

By rapidly rotating the potentiometer (POT) clockwise (see Figure 43), all timing functions will be removed for testing.

The conditions needed for the unit to enter test mode are as follows: POT must start at a time less than or equal to the 40 second mark. The POT must then be rapidly rotated to a position greater than or equal to the 280 second mark in less than ¼ second. Normal operation will resume after power is reset or after the unit has been in test mode for at least 5 minutes.

**Brownout Protection with Adjustment**

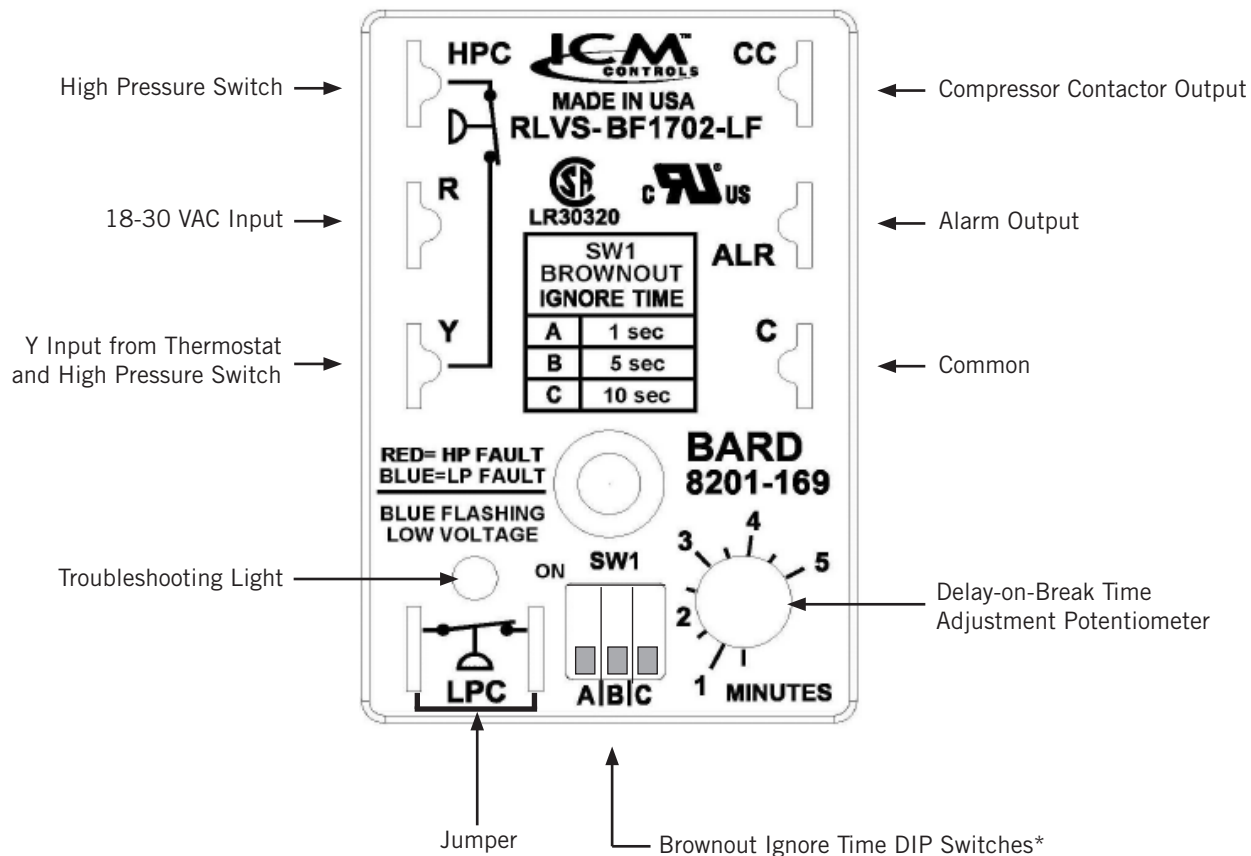
Brownout protection may be necessary if the utility power or generator power has inadequate power to prevent the voltage from dropping when the compressor starts. This is rare but can happen if the generator is undersized at the site or if the site is in a remote

location far from the main power grid. Under normal circumstances, allowing the brownout to be ignored for a time period should not be needed. The 8201-171 is shipped with all the DIP switches in the 'off' or 'do not ignore' position (see Figure 43).

If ignoring the brownout is needed because of the above conditions, three preset timers can be set by DIP switches in order to delay signaling a power brownout for a specific length of time after compressor contactor is energized. This allows the compressor a time period to start even if the voltage has dropped and allows the voltage to recover. This delay only happens when the CC terminal energizes. The delay can be set to 1 second (A DIP switch), 5 seconds (B DIP switch) or 10 seconds (C DIP switch); time is not cumulative—only the longest setting will apply. If the voltage recovers during the brownout delay period, the compressor will continue running.

If a brownout condition is detected by the 8201-171 at any point while there is a cooling call or power is on at Y, the troubleshooting light will flash blue. The light will continue to flash until the cooling call is

**FIGURE 43**  
**8201-171 Compressor Control Module**



\* Turn on only one switch for that specific ignore time setting. 10 seconds is the maximum brownout ignore time. If all switches are "off", the control is in "do not ignore".

satisfied or power is removed from the Y terminal. This condition does not prevent operation, it only indicates that a brownout condition was present at some point during the call. If a brownout condition is detected while CC has an output, CC will be de-energized and will retry after the delay-on-break timer is satisfied, honoring any DIP switch timer chosen when the CC output is re-energized; this process will continue until call is satisfied.

If inadequate utility or generator power continues after the Delay-on-Make or Delay-on-Break timer is fulfilled, the CC output will not energize. This could lead to the compressor never starting. The control will see the brownout immediately and not start.

A common scenario and one that has been seen in the field is when a unit or units switches from utility power to generator power. With slower transfer switches, the time delay between the utility power and generator power didn't cause a problem. The units lost power, shut off and came back on line normally. With the introduction of almost instantaneous transfer switches, the power glitch may be enough that the compressor will start to run backwards.

### High Pressure Safety Switch

All units have a high pressure switch as a safety device. This device will open when pressure in the system reaches 650 PSIG. The switch is directly connected to the dedicated compressor control module (see **High Pressure Detection** on page 27).

### Refrigerant High Pressure Alarm

When the wall-mount unit receives a signal from the compressor control module (CCM) indicating a high pressure event, the wall-mount unit will generate an alarm. Upon receiving the alarm, the wall-mount unit will remove the "Y" call from the CCM, resetting the status of the CCM. The alarm will stay present on the wall-mount unit until manually cleared with TEC-EYE hand-held diagnostic tool.

In addition to the CCM, the discharge pressure transducer is used to prevent a high pressure event. When the discharge pressure is above the discharge pressure alarm setpoint (set 30 pounds below high pressure switch, which is 650), the system will disable stage 2 of mechanical cooling.

### Phase Monitor

Used only on three phase equipment, the phase monitor is a compressor protection device that will prohibit operation of the compressor if the device senses a possible reverse-rotation situation due to incorrect phasing. On a call for compressor (and only compressor), the device will check incoming phase, check for severe voltage imbalance and check for proper frequency. Under nominal conditions, a green LED light will show on the face of the monitor. If there is improper phasing, voltage imbalance or frequency deviation, the device will

show a red LED light and prohibit compressor operation.

If a fault condition occurs, reverse two of the supply leads to the unit. **Do not reverse any of the unit factory wires as damage may occur.**

### Crankcase Heater

All units covered in this manual are provided with compressor crankcase heat.

This crankcase heater is a band-type heater located around the bottom of the compressor. This heater is controlled by the crankcase heater relay. The heater is only energized when the compressor is not running.

Crankcase heat is essential to prevent liquid refrigerant from migrating to the compressor, preventing oil pump out on compressor start-up and possible bearing or scroll vane failure due to compressing a liquid.

**IMPORTANT:** *The following procedure must be followed at initial start-up and at any time power has been removed for 12 hours or longer.*

To prevent compressor damage which may result from the presence of liquid refrigerant in the compressor crankcase:

1. Make certain the room thermostat is in the "off" position (the compressor is not to operate).
2. Apply power by closing the system disconnect switch. This energizes the compressor heater which evaporates the liquid refrigerant in the crankcase.
3. Allow 4 hours or 60 minutes per pound of refrigerant in the system as noted on the unit rating plate, whichever is greater.
4. After properly elapsed time, the thermostat may be set to operate the compressor.
5. **Do not open system disconnect switch except as required for safety while servicing.**

### Compressor Operation

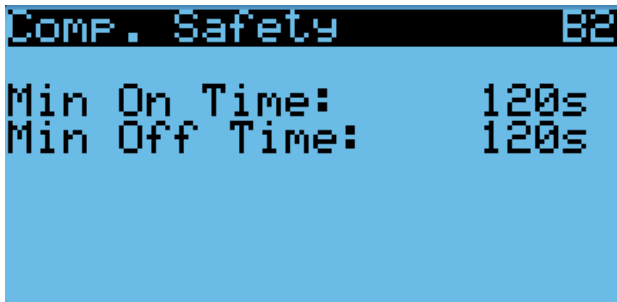
The compressor will be enabled when the unit (in orphan mode) or LC provide a cooling call. The compressor call from the controller has several delays that may affect the start or stop time of the compressor in regards to the cooling demand. The compressor has a minimum on time of 180 seconds to prevent short cycling the compressor. The compressor also has a minimum off time of 120 seconds to prevent start ups before the pressure in the refrigeration system equalizes. When the second stage is engaged, it also has a minimum run time of 120 seconds to allow the system to stabilize before returning to single stage or shutting down.

These delays can be changed by:

1. Press MENU key to go to the Main Menu screen.
2. Press UP or DOWN keys and ENTER key to enter TECHNICIAN password 1313.
3. Press UP or DOWN keys to scroll to **Adv System Config**; press ENTER key.

4. Press UP or DOWN keys to scroll to **Comp. Safety B2**; press ENTER key.
5. Press ENTER key to scroll to **Min On Time** or **Min Off Time** (see Figure 44).
6. Press UP or DOWN keys to change the value.
7. Press ENTER key to save value and move the cursor to next parameter or top of screen.
8. Press ESCAPE key several times to return to Main Menu screen.

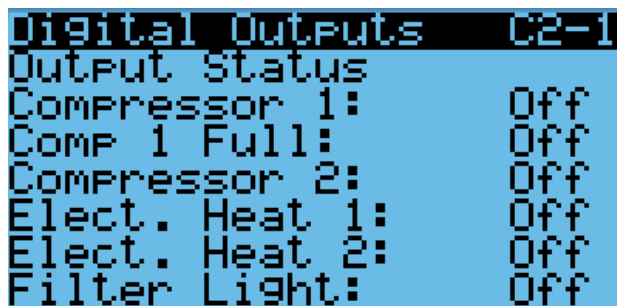
**FIGURE 44**  
Adjusting Compressor Delays



To view the status of the compressor outputs:

1. Press MENU key to go to the Main Menu screen.
2. Press UP or DOWN keys and ENTER key to enter TECHNICIAN password 1313.
3. Press UP or DOWN keys to scroll to **I/O Config**; press ENTER key.
4. Press UP or DOWN keys to scroll to **Digital Outputs**; press ENTER key.
5. Press UP or DOWN keys to scroll to **Digital Outputs C2-1**.
6. The status is displayed next to **Compressor 1**, **Comp 1 Full** and **Compressor 2** (see Figure 45).

**FIGURE 45**  
Verifying Compressor Output Status

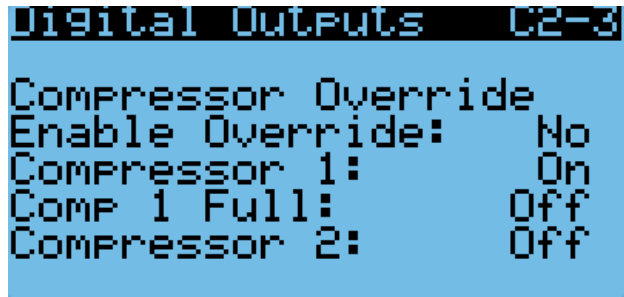


The compressor outputs can be put into override to aid in troubleshooting. The override will only stay active for 5 minutes.

To override the compressor outputs:

1. Press MENU key to go to the Main Menu screen.
2. Press UP or DOWN keys and ENTER key to enter TECHNICIAN password 1313.
3. Press UP or DOWN keys to scroll to **I/O Config**; press ENTER key.
4. Press UP or DOWN keys to scroll to **Digital Outputs**; press ENTER key.
5. Press UP or DOWN keys to scroll to **Digital Outputs C2-3**.
6. Press ENTER key to scroll to **Enable Override** (see Figure 46).
7. Press UP or DOWN key to change value to **Yes**.
8. Press ENTER key to scroll to selected compressor output.
9. Press UP or DOWN key to change value to **On** or **Off**.

**FIGURE 46**  
Overriding Compressor Outputs



### Additional Compressor Alarms

#### **Refrigerant Low Pressure Alarm**

When the suction pressure transducer indicates a pressure value less than the low pressure alarm setpoint of 40 PSIG and there is an active call for cooling, the controller will disable the compressor (after a 120-second delay). **NOTE:** *The second call will be delayed based on the delay off value mentioned in the compressor section.* The controller will try to run the refrigeration system two (2) times within 900 seconds before the alarm will lock the compressor out. This alarm needs to be manually cleared before compressor operation will resume.

## Economizer

### Economizer Components

#### Actuator

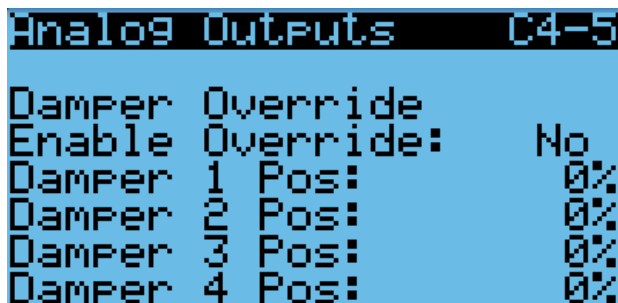
The actuator rotates up to 90° based on a 2-10V signal sent to it by the controller. This component is what opens and closes the damper blade. The unit is equipped with four dampers powered by four separate actuators. The left intake damper (damper 1) and the right intake damper (damper 3) are each powered by a 44 in-lb actuator. The left exhaust damper (damper 2) and right exhaust damper (damper 4) are powered by a 90 in-lb actuator. All dampers are spring return and will close the damper if power is lost.

To verify the output from the controller to the actuator:

1. Press MENU key to go to the Main Menu screen.
2. Press UP or DOWN keys and ENTER key to enter TECHNICIAN password 1313.
3. Press UP or DOWN keys to scroll to **Analog Outputs**; press ENTER key.
4. Press UP or DOWN keys to scroll to **Analog Outputs C4-5**.
5. To override the current position, press ENTER key to scroll to **Enable Override** (see Figure 47).
6. Press UP or DOWN keys to change the value to the desired output.
7. Press ENTER key to save the value and move cursor to **Damper 1 Pos**, **Damper 2 Pos**, **Damper 3 Pos**, or **Damper 4 Pos**.
8. Press UP or DOWN keys to change the value to the desired position.
9. The damper position will update with the new override value and the damper will travel to that position.

**NOTE:** This override will last for 5 minutes or until the **Enable Override** is changed back to **No**.

FIGURE 47  
Damper Override



#### Dust Sensor

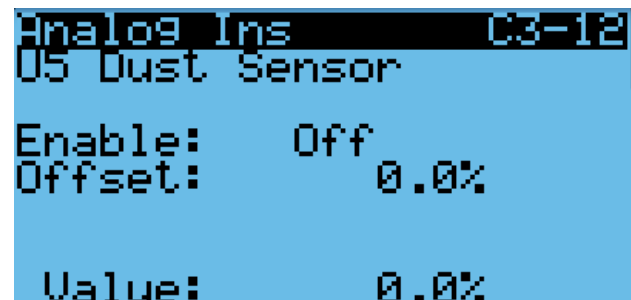
The unit has a dust sensor installed near the outdoor air inlet. The dust sensor checks for excessive particulates in the outdoor air, and will close the economizer if the dust is excessive. The sensor uses a PWM signal converted to 0-5V output to the controller.

To ensure proper performance, cleaning may be required. Vacuuming or blowing the dust off the sensor with forced air is recommended. **Avoid inserting any objects into the sensor.**

The dust sensor can be verified by:

1. Press MENU key to go to the Main Menu screen.
  2. Press UP or DOWN keys and ENTER key to enter TECHNICIAN password 1313.
  3. Press UP or DOWN keys to scroll to **I/O Config**; press ENTER key.
  4. Press UP or DOWN keys to scroll to **Analog Inputs**; press ENTER key.
  5. Press UP or DOWN keys to scroll to **Analog Ins C3-12**.
  6. Reference the **Value** for the current sensor reading (see Figure 48).
  7. To apply an offset to the current reading, press ENTER key to scroll to **Offset**.
  8. Press UP or DOWN keys to adjust the value to the desired value.
  9. Press ENTER key to save the value and move cursor to next parameter.
- NOTE:** The sensor can be disabled if required for troubleshooting.
10. With the cursor on the **Enable** parameter, press UP or DOWN keys to change the value from **On** to **Off**.
  11. Press ENTER key to save.

FIGURE 48  
Dust Sensor



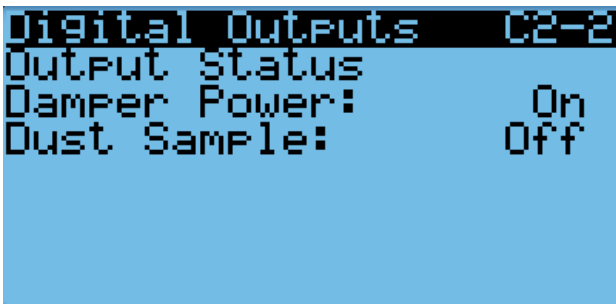
### Dust Sample

With the update to the 8301-091 dust sensor and new control board 8612-064, a dust sample is used to engage a small fan in the sensor. This command is automatically engaged by the controller when the economizer is being used.

To view the status of the dust sample output:

1. Press MENU key to go to the Main Menu screen.
2. Press UP or DOWN keys and ENTER key to enter TECHNICIAN password 1313.
3. Press UP or DOWN keys to scroll to **I/O Config**; press ENTER key.
4. Press UP or DOWN keys to scroll to **Digital Outputs**; press ENTER key.
5. Press UP or DOWN keys to scroll to **Digital Outputs C2-2**.
6. The status is displayed next to **Dust Sample** (see Figure 49).

**FIGURE 49**  
Verifying Dust Sample Output Status

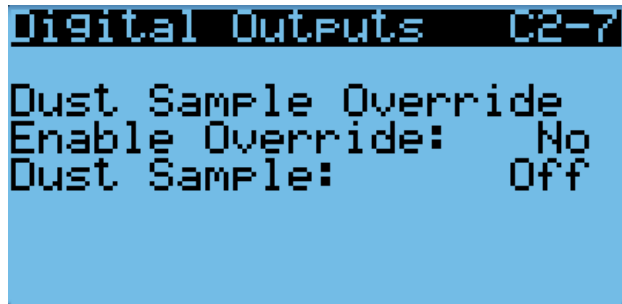


The dust sample output can be put into override to aid in troubleshooting. The override will only stay active for 5 minutes.

To override the dust sample output:

1. Press MENU key to go to the Main Menu screen.
2. Press UP or DOWN keys and ENTER key to enter TECHNICIAN password 1313.
3. Press UP or DOWN keys to scroll to **I/O Config**; press ENTER key.
4. Press UP or DOWN keys to scroll to **Digital Outputs**; press ENTER key.
5. Press UP or DOWN keys to scroll to **Digital Outputs C2-7**.
6. Press ENTER key to scroll to **Enable Override** (see Figure 50).
7. Press UP or DOWN key to change value to **Yes**.
8. Press ENTER key to scroll to **Dust Sample** output.
9. Press UP or DOWN key to change value to **On** or **Off**.

**FIGURE 50**  
Overriding Dust Sample Output



### Dust Sensor Failure Alarm

When the sensor reads a value that is outside of the acceptable 0 to 100% range, an alarm will be generated indicating the sensor has failed. This alarm is just a notification and will not disable any other features on the controller.

This alarm is fixed and cannot be adjusted.

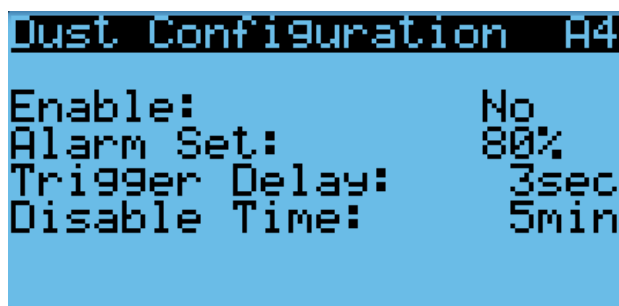
### High Dust Limit Alarm

When dust content in the air is high and is a risk to prematurely reducing airflow through the filters, the unit will restrict the use of the economizer. The controller has adjustable software setpoints to indicate dust levels are too high and to disable the economizer operation for 5 minutes. Once the conditions are no longer present, the alarm will automatically clear.

To adjust the dust sensor alarm setpoint:

1. Press MENU key to go to the Main Menu screen.
2. Press UP or DOWN keys and ENTER key to enter USER password 2000.
3. Press UP or DOWN keys to scroll to **System Config**; press ENTER key.
4. Press UP or DOWN keys to scroll to **Dust Configuration A4**.
5. Press ENTER key to scroll to **Alarm Set** (see Figure 51).

**FIGURE 51**  
Adjusting Dust Sensor Alarm Setpoint





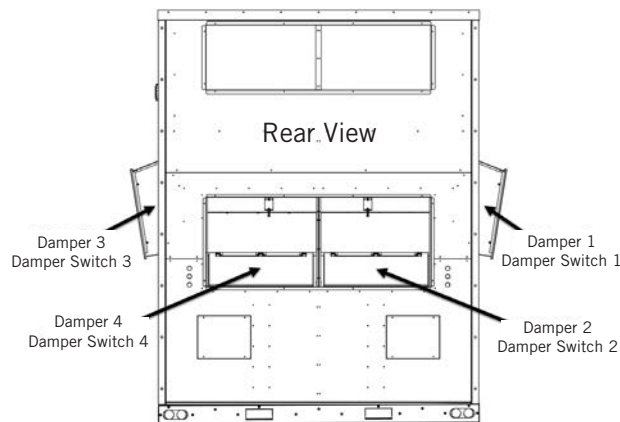
6. Press UP or DOWN keys to change to the desired value.
7. Press ENTER key to save the value.

**NOTE:** When the temperature outside is measured at or below 0°F, the dust sensor alarm will be disabled to allow economizer operation.

### Damper Blade

The system utilizes four damper blades to bring in outdoor air and exhaust space air for economizer operation. Damper 1 is left intake, damper 2 is left exhaust, damper 3 is right intake and damper 4 is right exhaust (see Figure 52). Damper blades are made of sheet metal and are integrated into the equipment.

**FIGURE 52**  
W180 Damper Blades



To view damper blade position:

1. Press MENU key to go to the Main Menu screen.
2. Press UP or DOWN keys and ENTER key to enter TECHNICIAN password 1313.
3. Press UP or DOWN keys to scroll to **I/O Config**; press ENTER key.
4. Press UP or DOWN keys to scroll to **Analog Outputs**; press ENTER key.
5. Press UP or DOWN keys to scroll to **Analog Outputs C4-1** (damper 1), **Analog Outputs C4-2** (damper 2), **Analog Outputs C4-3** (damper 3) or **Analog Outputs C4-4** (damper 4). See Figure 53.

**FIGURE 53**  
Damper Blade Position

```
Analog Outputs C4-1
      Damper 1
      Left Intake Damper
Position:                0%
```

```
Analog Outputs C4-2
      Damper 2
      Left Exhaust Damper
Position                0%
```

```
Analog Outputs C4-3
      Damper 3
      Right Intake Damper
Position                0%
```

```
Analog Outputs C4-4
      Damper 4
      Right Exhaust Damper
Position                0%
```

### Damper Switch

The economizer utilizes three magnetic switches (one on each damper blade) to determine if the damper is operating correctly. This switch will be closed when the damper is closed and open when the damper is open.

To verify the status of the switch:

1. Press MENU key to go to the Main Menu screen.
2. Press UP or DOWN keys and ENTER key to enter TECHNICIAN password 1313.
3. Press UP or DOWN keys to scroll to **I/O Config**; press ENTER key.

- Press UP or DOWN keys to scroll to **Digital Inputs**; press ENTER key.
- Press UP or DOWN keys to scroll to **Digital Ins C1-2**.
- Reference the values for **Damper 1**, **Damper 2**, **Damper 3** and **Damper 4** (see Figure 54).
- The input will display **ON** when the damper is closed (reflecting closed circuit on damper switch) and will display **OFF** when the damper is open (reflecting open circuit on damper switch).

**FIGURE 54**  
**Damper Switch**

Digital Ins			C1-2
Channel	En	Dir	Val
Filter 2	Yes	N/C	Off
Panel Sw	Yes	N/C	Off
Damper 1	Yes	N/O	On
Damper 2	Yes	N/O	On
Damper 3	Yes	N/O	On
Damper 4	Yes	N/O	On

#### **Damper Failed to Open Alarm**

When the controller commands the economizer damper actuator to a position other than 0% and the damper switch indicates the damper is not open, after a delay of 20 seconds the controller will generate a damper failed to open alarm. This alarm is just a notification and will not disable any features on the controller.

The alarm must be cleared by a user reset.

#### **Damper Failed to Close Alarm**

When the controller commands the economizer damper actuator to the 0% position and the damper switch indicates the damper is not closed, after a delay of 300 seconds the controller will generate a damper failed to close alarm. This alarm is just a notification and will not disable any features on the controller.

The alarm must be cleared by a user reset.

#### **Outdoor Temperature and Humidity Combination Sensor**

The unit is equipped with a combination outdoor temperature and humidity sensor to monitor outdoor conditions for the economizer operation. The temperature is measured with a 10k ohm NTC thermistor. The humidity is measured with a humidity sensor that outputs a 4-20mA signal to the controller.

The outdoor temperature can be verified by:

- Press MENU key to go to the Main Menu screen.
- Press UP or DOWN keys and ENTER key to enter TECHNICIAN password 1313.

- Press UP or DOWN keys to scroll to **I/O Config**; press ENTER key.
- Press UP or DOWN keys to scroll to **Analog Inputs**; press ENTER key.
- Press UP or DOWN keys to scroll to **Analog Ins C3-4**.
- Reference the **Value** to see the input of the sensor (see Figure 55).
- To apply an offset, press ENTER key to scroll to **Offset**.
- Press UP or DOWN keys to change to the desired value.
- Press ENTER key to save the value.

**FIGURE 55**  
**Outdoor Temperature Sensor**

Analog Ins		C3-4
B4 Outdoor Air Temp		
Enable:	On	
Offset:		0.0°F
Value:		72.7°F

The outdoor humidity can be verified by:

- Press MENU key to go to the Main Menu screen.
- Press UP or DOWN keys and ENTER key to enter TECHNICIAN password 1313.
- Press UP or DOWN keys to scroll to **I/O Config**; press ENTER key.
- Press UP or DOWN keys to scroll to **Analog Inputs**; press ENTER key.
- Press UP or DOWN keys to scroll to **Analog Ins C3-5**.
- Reference the **Value** to see the input of the sensor (see Figure 56).

**FIGURE 56**  
**Outdoor Humidity Sensor**

Analog Ins		C3-5
B5 Outdoor Humidity		
Enable:	On	
Offset:		0.0%rH
Value:		51.6%rH

7. To apply an offset, press ENTER key to scroll to **Offset**.
8. Press UP or DOWN keys to change to the desired value.
9. Press ENTER key to save the value.

#### **Outdoor Temperature Sensor Failure Alarm**

When the sensor reads a value that is outside of the acceptable -41 to 303.0° range, an alarm will be generated indicating the sensor has failed. This alarm condition will disable the economizer.

This alarm is fixed and cannot be adjusted.

#### **Outdoor Humidity Sensor Failure Alarm**

When the sensor reads a value that is outside of the acceptable 0 to 100% RH range, an alarm will be generated indicating the sensor has failed. This alarm condition will disable the economizer when the mode is set to temperature and humidity or enthalpy.

This alarm is fixed and cannot be adjusted.

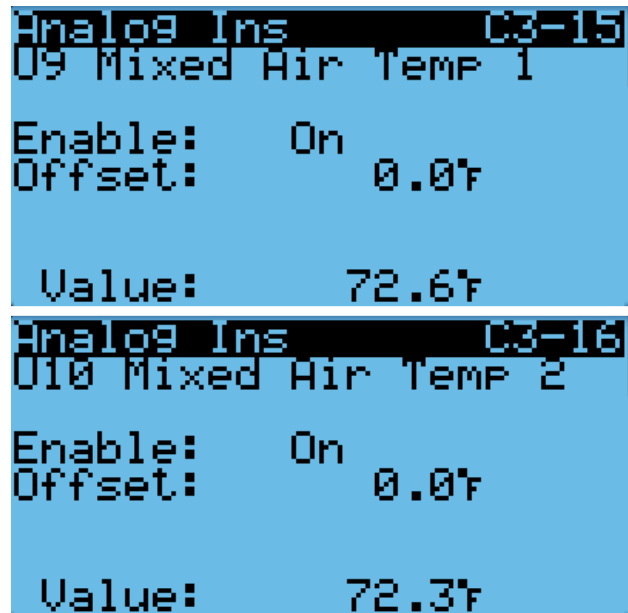
#### **Mixed Air Temperature Sensor**

The unit is equipped with two mixed air temperature sensors to monitor the mixed air temperature of each air path separately. The mixed air is measured where the economizers mix return air and outdoor air. This measurement is used to determine if the economizer is controlling correctly. These sensors are 10k ohm NTC thermistors, located in the blower section.

The mixed air temperature can be verified by:

1. Press MENU key to go to the Main Menu screen.
2. Press UP or DOWN keys and ENTER key to enter TECHNICIAN password 1313.
3. Press UP or DOWN keys to scroll to **I/O Config**; press ENTER key.
4. Press UP or DOWN keys to scroll to **Analog Inputs**; press ENTER key.
5. Press UP or DOWN keys to scroll to **Analog Ins C3-15 (Mixed Air Temp 1)** or **C3-16 (Mixed Air Temp 2)**.
6. Reference the **Value** to see the input of the sensor (see Figure 57).
7. To apply an offset, press ENTER key to scroll to **Offset**.
8. Press UP or DOWN keys to change to the desired value.
9. Press ENTER key to save the value.

**FIGURE 57**  
**Mixed Air Temperature Sensors**



#### **High Mixed Air Temperature Alarm**

To keep the economizer from bringing in air that is too warm, an alarm will be generated when the mixed air is 2° above the return air temperature for 300 seconds. This alarm will not be generated if the mixed air temperature sensor has failed. The alarm can only be activated during a free cooling call. The alarm is a user reset and must be cleared by the end user.

#### **Low Mixed Air Temperature Alarm**

To keep the economizer from bringing in air that is too cold, an alarm will be generated when the mixed air temperature is 5°F below the mixed air temperature control setpoint for 300 seconds. If this alarm is active, the economizer will be disabled for the current cooling call. This alarm will reference the mixed air temperature control setpoint to ensure that when the mixed air setpoint changes, the alarm dynamically changes with it. This alarm will not be generated if the mixed air temperature sensor has failed. The alarm can only be activated during a free cooling call and requires a user reset.

#### **Economizer Operation**

See Figure 93 on page 67 for ventilation airflow paths.

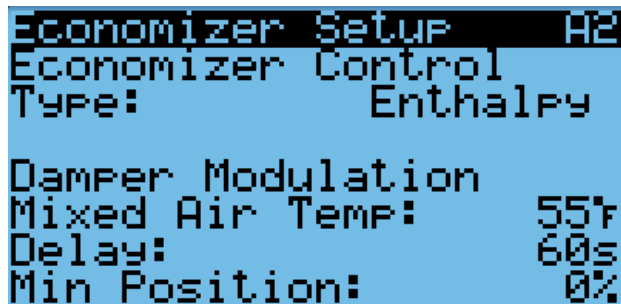
The vent option in the model number determines if the equipment has an economizer. If the value is set to "B", the controller will not use the economizer and the type on **Economizer Setup A2** will automatically change to **None**. The only exception to this is emergency ventilation will always attempt to open the dampers. This would only apply if a unit has an economizer but the controller is configured for no vent (B).

The economizer has four types of operation. The first mode is "None" where the economizer is never utilized, except for emergency purposes. The second mode is "Dry Bulb" where the outdoor temperature is the only consideration for economizer use on a free cooling call. The third mode is "TempHum" where the outdoor temperature and humidity are considered for economizer use on a free cooling call. The fourth mode is "Enthalpy" where the outdoor temperature, humidity and calculated dew point are considered for economizer operation on a free cooling call.

To change the economizer type:

1. Press MENU key to go to the Main Menu screen.
2. Press UP or DOWN keys and ENTER key to enter USER password 2000.
3. Press UP or DOWN keys to scroll to **System Config**; press ENTER key.
4. Press UP or DOWN keys to scroll to **Economizer Setup A2**; press ENTER key.
5. Press ENTER key to scroll to **Type** (see Figure 58).
6. Press UP or DOWN keys to change the **Type** desired value to **None**, **Dry Bulb**, **TempHum** or **Enthalpy**.
7. Press ENTER key to save the value and scroll to the next parameter.

**FIGURE 58**  
**Economizer Setup**



**NOTE:** The following parameters are for the temperature consideration for economizer use. Applies to **Dry Bulb**, **TempHum** and **Enthalpy** type.

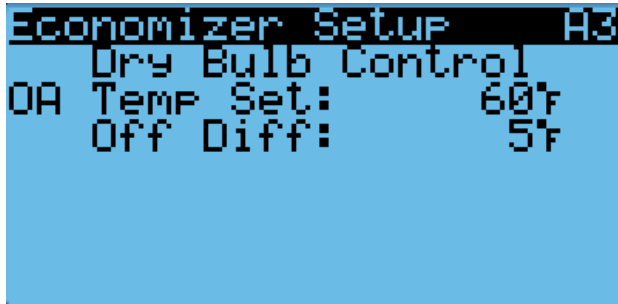
8. The cursor should now be on the **Mixed Air Temp** parameter.
9. Press UP or DOWN keys to change the parameter to the desired value.
10. Press ENTER key to save the value and scroll to the next parameter.
11. The cursor should now be on **Delay** parameter.
12. Press UP or DOWN keys to change the parameter to the desired value.

13. Press ENTER key to save the value and move to the next parameter.
14. The cursor is now on the **Min Position** parameter.
15. Press UP or DOWN keys to change the parameter to the desired value (see **Economizer Operation – Minimum Position** for more information).
16. Press ENTER key to save the value.
17. Press the DOWN key to navigate to the **Economizer Setup A3** screen.

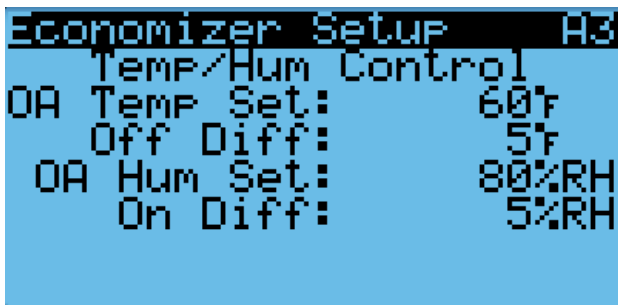
**NOTE:** The **Economizer Setup A3** screen will not display if economizer mode is set to **None**. Also, the contents of the screen will change depending on which type is chosen: **Dry Bulb** (Figure 59), **TempHum** (Figure 60) or **Enthalpy** (Figure 61). The following menu shows the **Enthalpy** content which also contains parameters that would be shown on **Dry Bulb** (temperature only) and **TempHum** (temperature and humidity only).

18. Press ENTER key to scroll to **OA Temp Set** (on **Drybulb Control** and **Temp/Hum Control A3** screens, this parameter will be titled **Outdoor Set**).
19. Press UP or DOWN keys to change the temperature setpoint to desired value.
20. Press ENTER key to save the value and scroll to **Off Diff**.
21. Press UP or DOWN keys to adjust the outdoor temperature differential for which the economizer is re-enabled.
22. Press ENTER key to save the value and scroll to **OA Hum Set**.
23. Press UP or DOWN keys to adjust the humidity setpoint to desired value.
24. Press ENTER key to save the value and scroll to **On Diff**.
25. Press UP or DOWN keys to adjust the outdoor humidity differential for which the economizer is re-enabled.
26. Press ENTER key to save the value and scroll to **Dew Pt. Set**.
27. Press UP or DOWN keys to adjust the outdoor dew point setpoint for economizer operation to the desired value.
28. Press ENTER key to save the value and scroll to **On Diff**.
29. Press UP or DOWN keys to adjust the dew point differential for which the economizer is re-enabled.
30. Press ENTER key to save the value.
31. Press ESCAPE key several times to return to Main Menu screen.

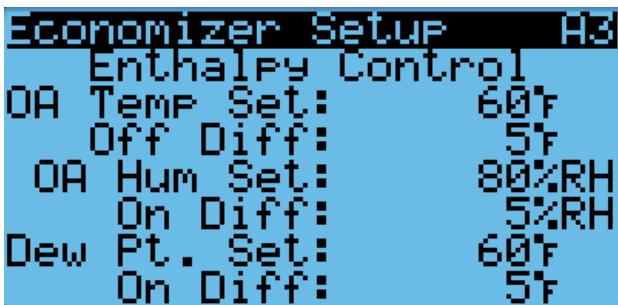
**FIGURE 59**  
Economizer Setup – Dry Bulb Control



**FIGURE 60**  
Economizer Setup – Temp/Hum Control



**FIGURE 61**  
Economizer Setup – Enthalpy Control



See Table 11 for default settings for economizer operation.

When the economizer is activated during a free cooling call only, using any of the previously mentioned modes, a 0-10V analog signal will be sent to the economizer actuator. The actuator will then open and close the damper blades to maintain a mixed air temperature of 55°F. When the mixed air temperature increases, the damper will open and when the mixed air temperature decreases, the damper will close.

The economizer may be disabled by the LC if the system determines it needs to enter dehumidification mode. More information about the dehumidification sequence can be found in the latest revision of LC6000 Service Instructions 2100-669. In addition to dehumidification mode, the economizer may be disabled for 5 minutes (adjustable) if the dust sensor indicates the outdoor air may cause particulate buildup in the air filters. After the time has expired and on a call for cooling, the economizer will open again to sample the air. The wall-mount unit will either return to normal operation or remain locked out for another 5 minutes.

**Economizer Operation – Minimum Position**

The economizer has an option to set minimum position for the economizer. The minimum position will only be active while the blower is operating. To enable minimum position all the time, continuous blower must be activated for the wall unit in the LC6000. See latest version of LC6000 Service Instructions 2100-669 for continuous blower configuration.

To set the minimum position value:

1. Press MENU key to go to the Main Menu screen.
2. Press UP or DOWN keys and ENTER key to enter USER password 2000.
3. Press UP or DOWN keys to scroll to **System Config**; press ENTER key.
4. Press UP or DOWN keys to scroll to **Economizer Setup A2**.
5. Press ENTER key to scroll to **Min Position** (see Figure 58).
6. Press UP or DOWN keys to change to the desired value.

**TABLE 11**  
Economizer Default Settings

Mode		Consideration	Economizer Available for Cooling	Economizer Not Available for Cooling	
Temp Only	Temp & Humidity	Enthalpy*	Temperature	When the outdoor air temperature is below 70°F	When the outdoor air temperature is above 75°F
			Humidity	When the outdoor humidity is below 80%	When the outdoor humidity is above 80%
			Dew Point	When the outdoor dew point is below 55°F	When the outdoor dew point is above 60°F

\* In Enthalpy mode, outdoor temperature, humidity and calculated dew point are all considered for economizer operation.

## Miscellaneous Components

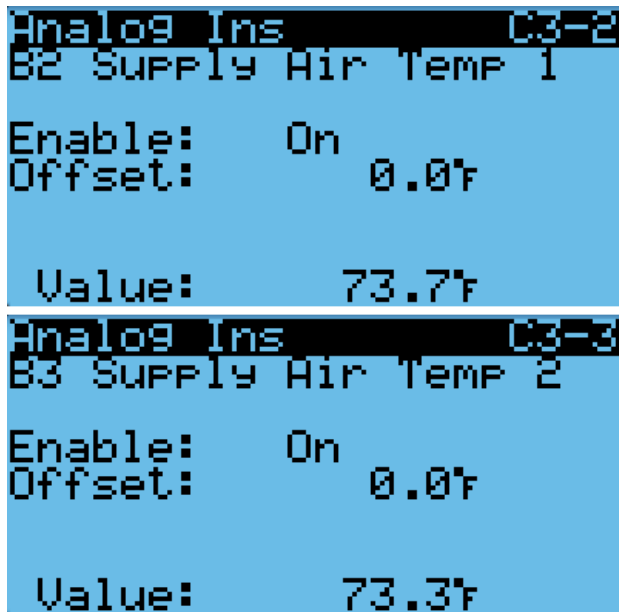
### Supply Temperature Sensor

The unit is equipped with two supply air temperature sensors, located in the supply opening of each air path, to monitor the leaving air temperature of the unit. The temperature is measured with a 10k ohm NTC thermistor.

The supply air temperature can be verified by:

1. Press MENU key to go to the Main Menu screen.
2. Press UP or DOWN keys and ENTER key to enter TECHNICIAN password 1313.
3. Press UP or DOWN keys to scroll to **I/O Config**; press ENTER key.
4. Press UP or DOWN keys to scroll to **Analog Inputs**; press ENTER key.
5. Press UP or DOWN keys to scroll to **Analog Ins C3-2 (Supply Air Temp 1)** or **C3-3 (Supply Air Temp 2)**.
6. Reference the **Value** to see the input of the sensor (see Figure 62).
7. To apply an offset, press ENTER key to scroll to **Offset**.
8. Press UP or DOWN keys to change to the desired value.
9. Press ENTER key to save the value.

**FIGURE 62**  
Supply Air Temperature Sensor



### Supply Temperature Sensor Failure Alarm

When the sensor reads a value that is outside of the acceptable -41.0 to 303.0° range, an alarm will be generated indicating the sensor has failed.

This alarm is fixed and cannot be adjusted.

### Emergency Cooling Mode

If the shelter temperature is above the high temperature alarm setpoint on the LC, the unit will be commanded into emergency cooling mode. In this mode, the unit will operate the economizer regardless of the economizer setup, as long as the outdoor temperature is below the indoor temperature. This will stay active until the LC returns the unit to normal operation.

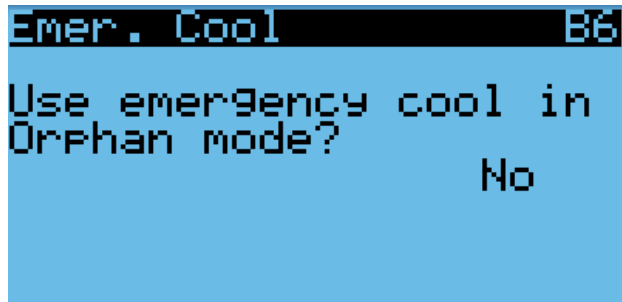
#### Emergency Cooling – Orphan Mode

When the unit is not connected to the LC6000 and operating in orphan mode, the unit still has the capability to operate in emergency cooling mode. By default this feature is not enabled.

To enable emergency cooling in orphan mode:

1. Press MENU key to go to the Main Menu screen.
2. Press UP or DOWN keys and ENTER key to enter TECHNICIAN password 1313.
3. Press UP or DOWN keys to scroll to **Adv System Config**; press ENTER key.
4. Press UP or DOWN keys to scroll to **Emer. Cool B6**.
5. Press ENTER key to scroll to **Use emergency cool in Orphan mode?** (see Figure 63).
6. Press UP or DOWN keys to change the value.

**FIGURE 63**  
Emergency Cool – Orphan Mode



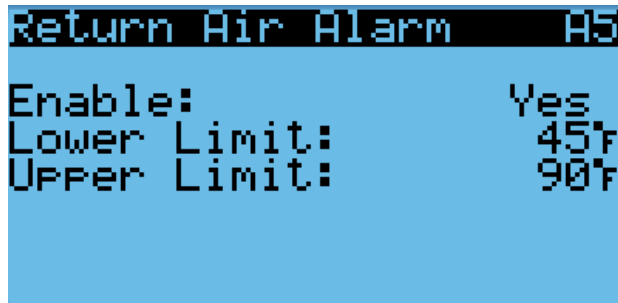
When this feature is used instead of using the zone sensor, an alarm will be triggered by the high return air temperature alarm.

To adjust the return air temperature settings:

1. Press MENU key to go to the Main Menu screen.
2. Press UP or DOWN keys and ENTER key to enter USER password 2000.
3. Press UP or DOWN keys to scroll to **System Config**; press ENTER key.

4. Press UP or DOWN keys to scroll to **Return Air Alarm A5**.
5. Press ENTER key to scroll to **Enable, Lower Limit** or **Upper Limit** (see Figure 64).
6. Press UP or DOWN keys to disable the alarm or change the limit values.

**FIGURE 64**  
Adjusting Return Air Alarm Settings



## Emergency Ventilation Mode

If the emergency ventilation input at the LC is active, the system will go into emergency ventilation mode. In emergency ventilation mode, the economizers on the wall units will be commanded to 100%. This mode is only available when connected to the LC.

**NOTE:** All units will receive the emergency ventilation command. Wall units not equipped with economizers will still engage the blower.

## Electric Heat Option

### Electric Heat Components

#### Electric Heating Element

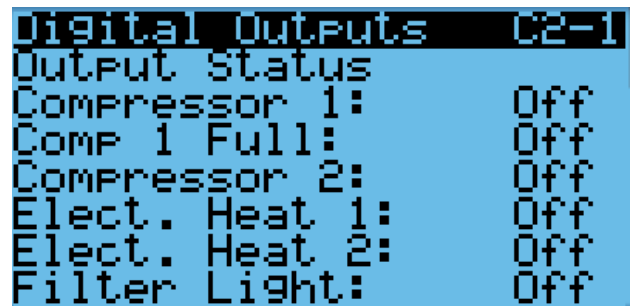
The unit can be optionally equipped with 9kw, 18kw or 36kw of heat: The 9kw option is a single stage heating element, the 18kw option comes equipped with two 9kw heating elements that operate in two stages and the 36kw option comes equipped with two 18kw heating elements that operate in two stages. The heating elements are located downstream of the evaporator coils and can be accessed through the upper control panel door.

To view the status of the electric heat outputs:

1. Press MENU key to go to the Main Menu screen.
2. Press UP or DOWN keys and ENTER key to enter TECHNICIAN password 1313.
3. Press UP or DOWN keys to scroll to **I/O Config**; press ENTER key.
4. Press UP or DOWN keys to scroll to **Digital Outputs**; press ENTER key.
5. Press UP or DOWN keys to scroll to **Digital Outputs C2-1**.

6. The status is displayed next to **Elect. Heat 1** and **Elect. Heat 2** (see Figure 65).

**FIGURE 65**  
Verifying Electric Heat Output Status

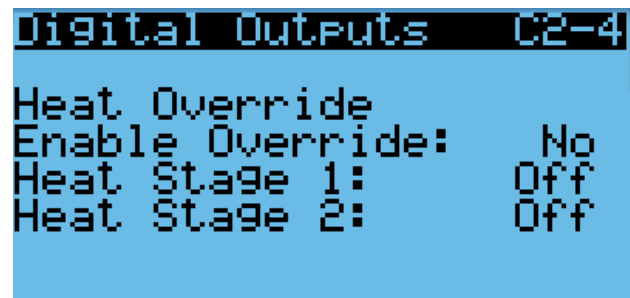


The electric heat outputs can be put into override to aid in troubleshooting. The override will only stay active for 5 minutes.

To override the electric heat outputs:

1. Press MENU key to go to the Main Menu screen.
2. Press UP or DOWN keys and ENTER key to enter TECHNICIAN password 1313.
3. Press UP or DOWN keys to scroll to **I/O Config**; press ENTER key.
4. Press UP or DOWN keys to scroll to **Digital Outputs**; press ENTER key.
5. Press UP or DOWN keys to scroll to **Digital Outputs C2-4**.
6. Press ENTER key to scroll to **Enable Override** (see Figure 66).
7. Press UP or DOWN key to change value to **Yes**.
8. Press ENTER key to scroll to selected electric heat output.
9. Press UP or DOWN key to change value to **On** or **Off**.

**FIGURE 66**  
Overriding Electric Heat Output



## Thermal Overload

The heater assembly has a thermal overload wired in series with the heating element. This device has a cycling limit. For S voltage models, the limit opens at 190°F and resets at 140°F. For N, Q and T voltage models, the limit opens at 180°F and resets at 130°F. The limit is also equipped with a redundant thermal fuse that will open at 240°F.

## Electric Heat Operation

The heat strip will be activated on a call for heat. This call can be generated by the LC or the wall-mount unit operating in orphan mode or stand-alone mode.

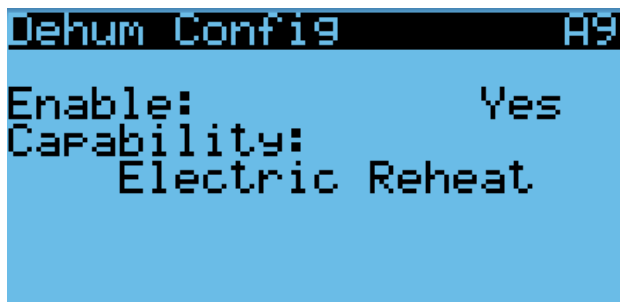
## Electric Reheat Dehumidification

The MEGA-TEC wall-mount unit can be ordered with optional electric reheat dehumidification. This feature is indicated by the letter “E” in the 6th character of the model number. Electric reheat dehumidification is only available as a factory-installed option that must be ordered with the unit. It cannot be installed in the field on an existing unit.

To verify the dehumidification capability of a unit and/or disable the dehumidification operation:

1. Press MENU key to go to the Main Menu screen.
2. Press UP or DOWN keys and ENTER key to enter USER password 2000.
3. Press UP or DOWN keys to scroll to **System Config**; press ENTER key.
4. Press UP or DOWN keys to scroll to **Dehum Config A9** (see Figure 67).

**FIGURE 67**  
Electric Reheat Dehumidification



**NOTE:** Capability on this menu will show the unit's dehumidification capability based on the model number entered into the wall-mount unit's controller. This parameter will show either **Not Available** or **Electric Reheat**.

5. Press ENTER key to scroll to **Enable**.
6. Press UP or DOWN keys to change the value from **Yes** to **No**.

An electric reheat capable unit will allow for concurrent operation of compressor and electric heat. This allows the compressor to operate which will remove moisture from the indoor air while the electric heat keeps the space temperature from dropping during this operation.

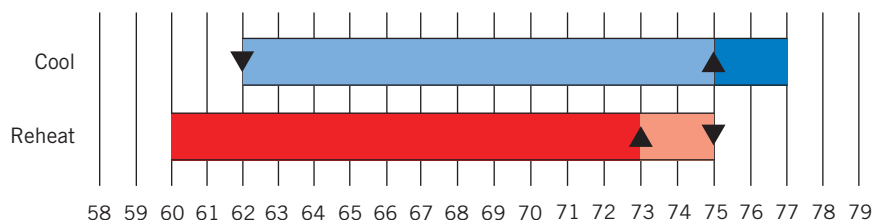
## Electric Reheat Dehumidification Operation

The unit will utilize electric reheat dehumidification when it receives an active dehumidification call from the LC6000 supervisory controller. During the active dehumidification call, the unit status message will show “Active Dehum”. An LC6000 equipped with an indoor humidity sensor is required to utilize dehumidification.

On a call for electric reheat dehumidification, the unit return air sensor will control the compressor and heating element operation based on the supervisory control setpoints. If the space temperature, based on the sensor attached to the supervisory control, reaches the cooling or heating setpoint, the dehumidification call is overridden until the cooling or heating call is satisfied. If communication is lost with the supervisory controller during a dehumidification call, the electric reheat function at the unit is lost and the unit will operate in orphan mode.

During a call for electric reheat, the wall unit will energize the compressor and the electric reheat coil. It will be energized to extend the run time of the cooling cycle, mitigating the cooling done by the compressor. If/when the temperature falls to 2° above heating setpoint, the compressor will be disabled until the temperature is increased 2° below the cooling setpoint and then the compressor will be re-energized (see Figure 68). If/when the temperature reaches 4° below the cooling setpoint, the electric heating elements will be energized. The electric heating elements will be disabled 2° below the cooling setpoint. The system will continue the dehumidification process until either the

**FIGURE 68**  
Dehumidification Control (°F)





heating or cooling setpoint are reached again or the requirement for dehumidification is no longer present.

A call for electric dehumidification is ignored if there is a call for emergency vent, emergency cool or emergency off.

For more information on dehumidification staging, see latest version of LC6000 Service Instructions manual 2100-669.

## Unit Disable Option

The wall-mount unit can be disabled by opening a dry set of contacts connected to Input DI1 on the PLC board. This feature can be used in addition to the emergency off feature provided by the LC6000 to ensure that the unit does not operate even when in orphan mode. This feature is disabled by default and must be enabled before the input will affect unit operation. When the input detects open contacts, all unit operation will stop and the dampers will close. This is an automatic reset feature that will resume operation as soon as the unit detects the contacts are closed again.

For applications that require the dampers to close rapidly, the 24VAC power supplied to each actuator should be removed so the actuator spring returns. In normal operation, the dampers can take up to 2 minutes to close from fully open. When the 24VAC power is removed from the actuator, the dampers will close in under 30 seconds using the spring return on the actuator.

Beginning with software version MGS1000.1.3.0, output NO9 can be wired in series with the actuators to utilize the spring return when unit disable or emergency off are active on the controller.

**NOTE:** Alarm logging and trend logging will not be available if power is removed from the controller and unit offline alarms will be recorded on the LC6000.

The unit disable input can be verified and adjusted by:

1. Press MENU key to go to the Main Menu screen.
2. Press UP or DOWN keys and ENTER key to enter TECHNICIAN password 1313.
3. Press UP or DOWN keys to scroll to **I/O Config**; press ENTER key.
4. Press UP or DOWN keys to scroll to **Digital Inputs**; press ENTER key.
5. Press UP or DOWN keys to scroll to **Digital Ins C1-1**.
6. Reference **Disable** row and **En** column (see Figure 69).
7. Press ENTER key to scroll to **Disable En** value.
8. Press UP or DOWN key to change value.
9. Press ENTER key to scroll to **Dir**.

10. Press UP or DOWN key to change direction (**N/O** or **N/C**), if applicable.
11. Press ESCAPE key several times to return to Main Menu screen.

**FIGURE 69**  
Unit Disable Option

Digital Ins		C1-1	
Channel	En	Dir	Val
Disable	No	N/C	Off
CCM1	Yes	N/O	Off
CCM2	Yes	N/O	Off
Airflw 1	Yes	N/C	Off
Airflw 2	Yes	N/C	Off
Filter 1	Yes	N/C	Off

To verify the status of the damper power output:

1. Press MENU key to go to the Main Menu screen.
2. Press UP or DOWN keys and ENTER key to enter TECHNICIAN password 1313.
3. Press UP or DOWN keys to scroll to **I/O Config**; press ENTER key.
4. Press UP or DOWN keys to scroll to **Digital Outputs**; press ENTER key.
5. Press UP or DOWN keys to scroll to **Digital Outputs C-2-2** (see Figure 70).

**FIGURE 70**  
Verifying Damper Power Output Status

Digital Outputs		C2-2
Output Status		
Damper Power:		On
Dust Sample:		Off

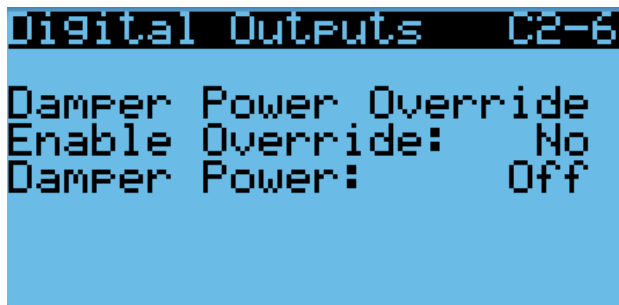
If the function of the output needs to be verified, the output can be put into override. To override the output:

1. Press MENU key to go to the Main Menu screen.
2. Press UP or DOWN keys and ENTER key to enter TECHNICIAN password 1313.
3. Press UP or DOWN keys to scroll to **I/O Config**; press ENTER key.
4. Press UP or DOWN keys to scroll to **Digital Outputs**; press ENTER key.

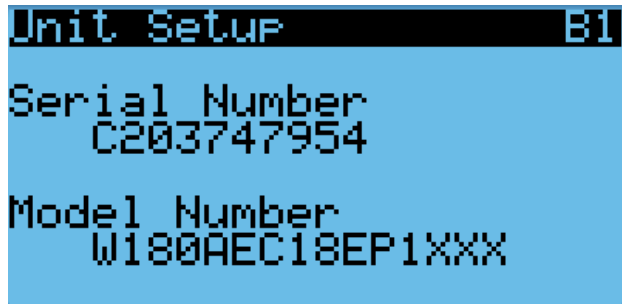
5. Press UP or DOWN keys to scroll to **Digital Outputs C2-6** (see Figure 71).
6. Press ENTER key to scroll to **Enable Override**.
7. Press UP or DOWN key to change from **No** to **Yes**.
8. Press ENTER key to scroll to **Damper Power**.
9. Press UP or DOWN key to set to **On** to power the actuator or **Off** to spring return the actuator.

**NOTE:** This override will only last for 5 minutes and then return to normal operation.

**FIGURE 71**  
Overriding Damper Output



**FIGURE 72**  
Serial/Model Number Configuration



### Serial/Model Number Configuration

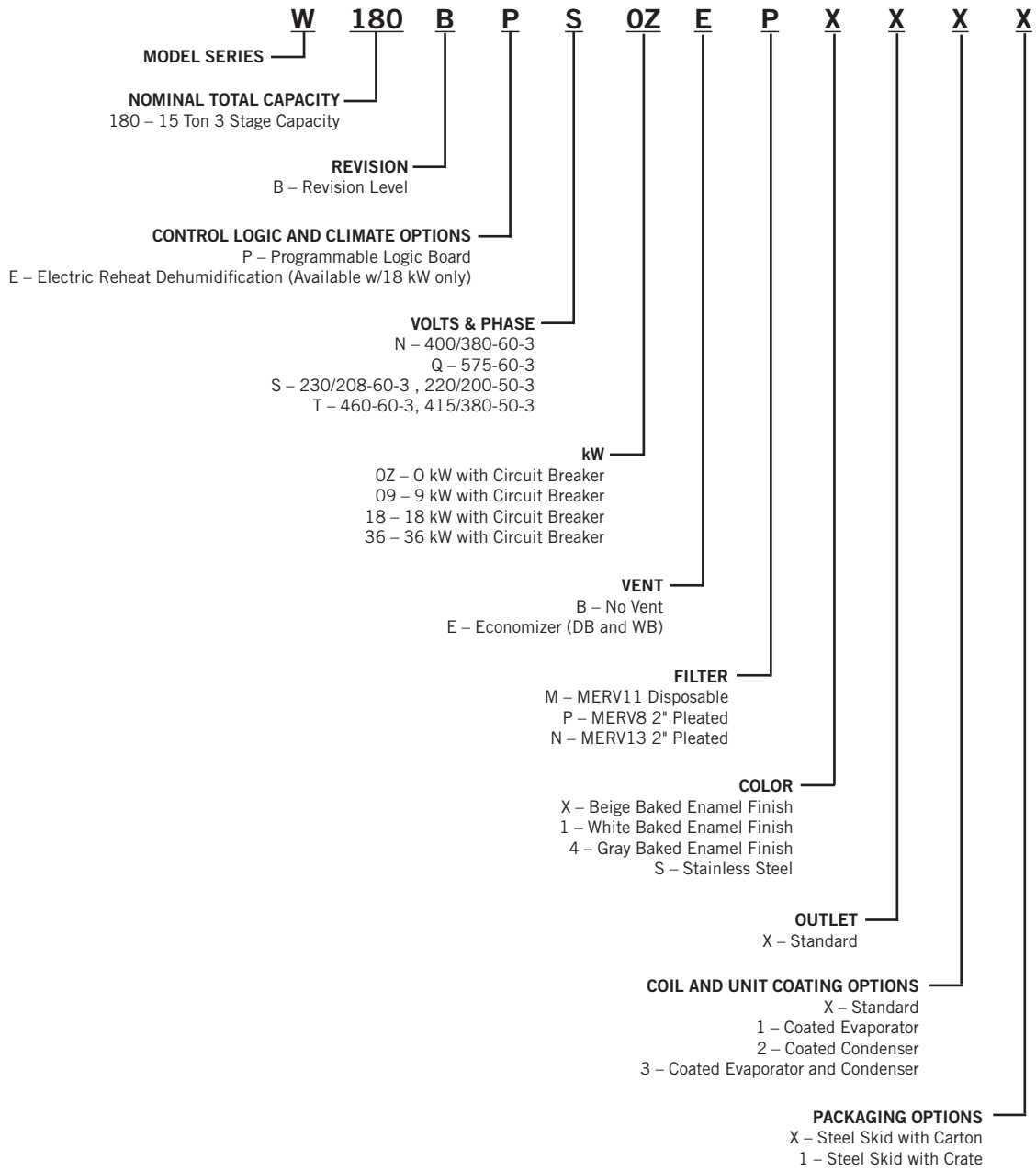
MEGA-TEC wall-mount units configure some settings based on the model number that is input into the unit. The model and serial number are entered at the factory, and should be retained during a software update. However, after a software update, it is best practice to verify that the model number and serial number are still present and accurate. If the model number and/or serial number is missing or incorrect, they will need to be re-entered.

To update serial/model numbers:

1. Press MENU key to go to the Main Menu screen.
2. Press UP or DOWN keys and ENTER key to enter ENGINEER password 9254.
3. Press UP or DOWN keys to scroll to **Adv. Sys. Config**; press ENTER key.
4. Press UP or DOWN keys to scroll to **Unit Setup B1** (see Figure 72).
5. Press ENTER key to advance the cursor to the digit that needs changed in the serial/model number.
6. Press UP or DOWN keys to change value of the digit.
7. Continue Steps 5 and 6 until the serial/model number(s) are correct and reflect the number on the product label.

For more information on the options and settings available for specific model numbers, see the model number breakdown in Figure 73.

**FIGURE 73**  
**MEGA-TEC Wall-Mount Unit Model Nomenclature**



# REFRIGERANT INFORMATION

## NOTICE

These units require R-410A refrigerant and polyol ester oil.

### General

1. Use separate service equipment to avoid cross contamination of oil and refrigerants.
2. Use recovery equipment rated for R-410A refrigerant. Recover from both high and low side of system.
3. Use manifold gauges rated for R-410A (800 PSI/250 PSI low).
4. R-410A is a binary blend of HFC-32 and HFC-125.
5. R-410A is nearly azeotropic—similar to R-22 and R-12. Although nearly azeotropic, charge with liquid refrigerant.
6. R-410A operates at 40-70% higher pressure than R-22, and systems designed for R-22 cannot withstand this higher pressure.
7. R-410A has an ozone depletion potential of zero, but must be reclaimed due to its global warming potential.
8. R-410A compressors use polyol ester oil.
9. Polyol ester oil is hygroscopic; it will rapidly absorb moisture and strongly hold this moisture in the oil.
10. A liquid line dryer must be used—even a deep vacuum will not separate moisture from the oil.
11. Limit atmospheric exposure to 15 minutes.
12. If compressor removal is necessary, always plug compressor immediately after removal. Purge with small amount of nitrogen when inserting plugs.

### Topping Off System Charge

If a leak has occurred in the system, Bard Manufacturing recommends reclaiming, evacuating (see criteria above) and charging to the nameplate charge. If done correctly, topping off the system charge can be done without problems.

With R-410A, there are no significant changes in the refrigerant composition during multiple leaks and recharges. R-410A refrigerant is close to being an azeotropic blend (it behaves like a pure compound or single component refrigerant). The remaining refrigerant charge in the system may be used after leaks have occurred. “Top-off” the charge by utilizing the pressure charts on the inner control panel cover as a guideline.

**REMEMBER:** When adding R-410A refrigerant, it must come out of the charging cylinder/tank as a liquid to avoid any fractionation and to insure optimal system performance. Refer to instructions for the cylinder that is being utilized for proper method of liquid extraction.

### Safety Practices

1. Never mix R-410A with other refrigerants.
2. Use gloves and safety glasses. Polyol ester oils can be irritating to the skin, and liquid refrigerant will freeze the skin.
3. Never use air and R-410A to leak check; the mixture may become flammable.
4. Do not inhale R-410A—the vapor attacks the nervous system, creating dizziness, loss of coordination and slurred speech. Cardiac irregularities, unconsciousness and ultimately death can result from breathing this concentration.
5. Do not burn R-410A. This decomposition produces hazardous vapors. Evacuate the area if exposed.
6. Use only cylinders rated DOT4BA/4BW 400.
7. Never fill cylinders over 80% of total capacity.
8. Store cylinders in a cool area, out of direct sunlight.
9. Never heat cylinders above 125°F.
10. Never trap liquid R-410A in manifold sets, gauge lines or cylinders. R-410A expands significantly at warmer temperatures. Once a cylinder or line is full of liquid, any further rise in temperature will cause it to burst.

### Important Installer Note

For improved start-up performance, wash the indoor coil with a dishwashing detergent.

### R410-A Refrigerant Charge

This wall-mount unit was charged at the factory with the quantity of refrigerant listed on the serial plate. AHRI capacity and efficiency ratings were determined by testing with this refrigerant charge quantity.

Table 12 shows nominal pressures for the units. The use of pressure gauges should not be necessary as the measurements are available through the TEC-EYE hand-held diagnostic too. Since many installation specific situations can affect the pressure readings, this information should only be used by certified technicians as a guide for evaluating proper system performance. They shall not be used to adjust charge. If charge is in doubt, reclaim, evacuate and recharge the wall-mount unit to the serial plate charge.

## Pressure Service Ports

High and low pressure service ports are installed on all wall-mount units so that the system operating pressures can be observed. Pressures are shown in Table 12.

This unit employs high-flow Coremax valves instead of the typical Schrader type valves.

**WARNING! Do NOT use a Schrader valve core removal tool with these valves. Use of such a tool could result in eye injuries or refrigerant burns!**

To change a Coremax valve without first removing the refrigerant, a special tool is required which can be obtained at [www.fastestinc.com/en/SCCA07H](http://www.fastestinc.com/en/SCCA07H). See the replacement parts manual for replacement core part numbers.

**TABLE 12**  
**W180 Cooling Pressures (S, T, Q and N Voltage Models)**

Cooling Air Temperature Entering Outdoor Coil °F														
Model	Return Air Temp (DB/WB)	Pressure	75	80	85	90	95	100	105	110	115	120	125	131
W180 Stage 3 <sup>1</sup>	75°/62°	Low Side	126	127	128	129	130	131	132	133	134	135	136	138
		High Side	315	340	364	388	412	435	459	481	504	526	548	573
	80°/67°	Low Side	135	136	137	138	139	140	141	142	143	145	146	147
		High Side	323	348	374	398	423	447	470	494	517	539	562	588
	85°/72°	Low Side	140	141	142	143	144	145	146	147	148	150	151	152
		High Side	334	361	387	412	437	462	487	511	535	558	581	609
W180 Stage 2 <sup>2</sup>	75°/62°	Low Side	138	140	141	142	143	143	143	142	141	140	138	136
		High Side	318	342	365	389	412	435	458	480	502	524	545	570
	80°/67°	Low Side	148	150	151	152	153	153	153	152	151	150	148	145
		High Side	326	350	375	399	423	446	469	492	515	537	559	585
	85°/72°	Low Side	153	155	156	157	158	158	158	157	156	155	153	150
		High Side	337	363	388	413	438	462	486	509	533	556	579	605
W180 Stage 1 <sup>3</sup>	75°/62°	Low Side	129	130	130	131	132	133	135	136	137	138	139	141
		High Side	312	341	367	392	415	435	454	470	485	497	508	518
	80°/67°	Low Side	138	139	140	141	142	143	144	145	146	148	149	151
		High Side	320	350	377	402	425	446	465	482	497	510	521	531
	85°/72°	Low Side	142	143	144	145	147	148	149	150	152	153	154	156
		High Side	332	362	390	416	440	462	482	499	515	528	539	550

Low side pressure ± 4 PSIG

High side pressure ± 10 PSIG

<sup>1</sup> Stage 3 is circuit 1 *fully loaded* and circuit 2 *on*.

<sup>2</sup> Stage 2 is circuit 1 *unloaded* and circuit 2 *on*.

<sup>3</sup> Stage 1 is circuit 1 *unloaded* and circuit 2 *off*.

Tables are based upon **rated CFM** (airflow) across the evaporator coil. If there is any doubt as to correct operating charge being in the system, the charge should be removed and system evacuated and recharged to serial plate charge weight.

**NOTE:** Pressure table based on high speed condenser fan operation. If condensing pressures appear elevated, check condenser fan wiring. See **Condenser Fan Operation** on page 26.

# MAINTENANCE & TROUBLESHOOTING

## Standard Maintenance Procedures

### WARNING

**Electrical shock hazard.**

**Disconnect all power supplies before servicing.**

**Failure to do so could result in electric shock or death.**

### CAUTION

**Cut hazard.**

**Wear gloves to avoid contact with sharp edges.**

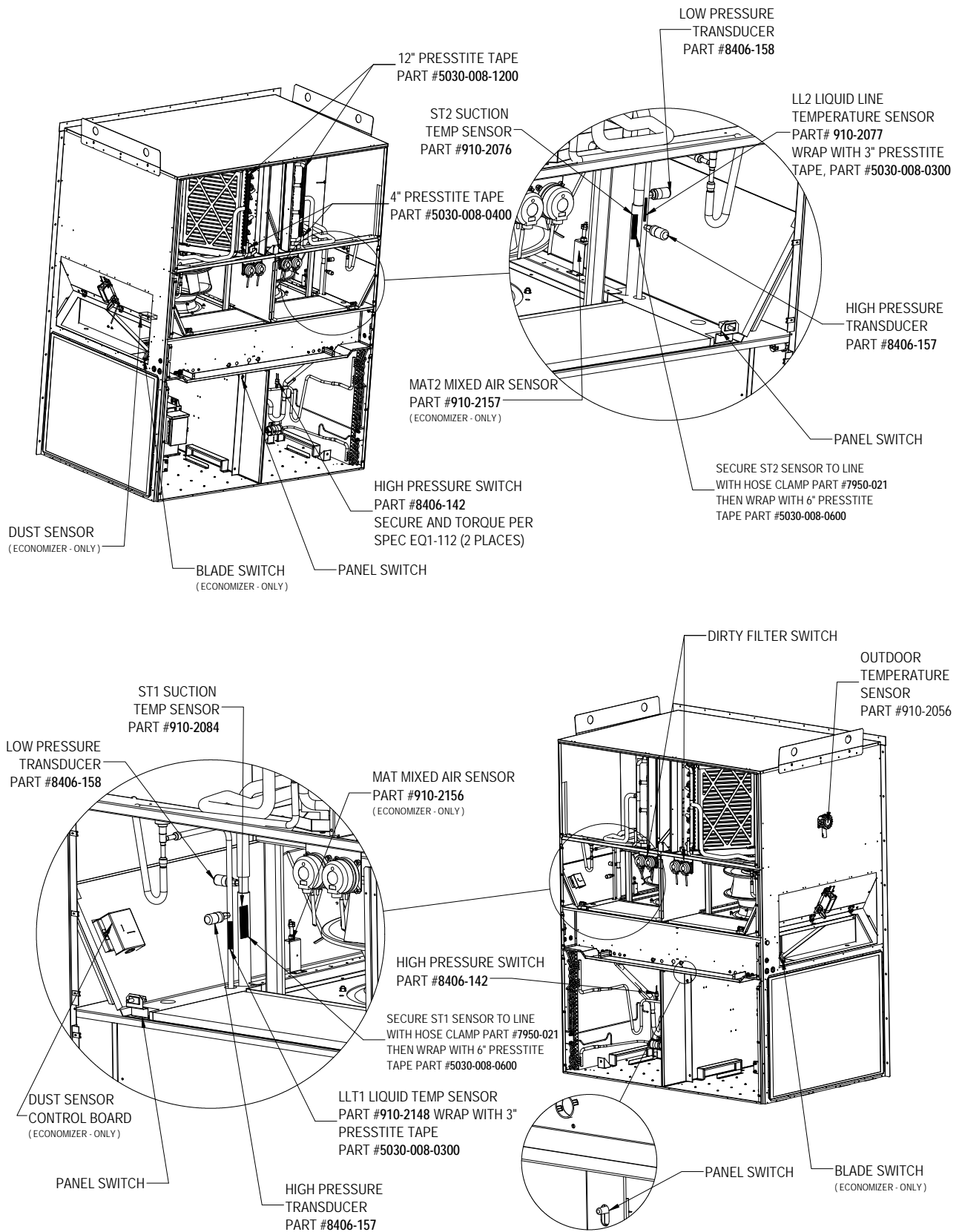
**Failure to do so could result in personal injury.**

1. Disable system from LC6000 controller (see latest revision of LC6000 Service Instructions 2100-669).
2. Turn off AC breakers at wall-mount units.
3. Check inlet sides of condenser and evaporator coils for obstructions/debris—clean if necessary using a quality manufactured coil cleaning product specific for the evaporator or condenser coil.
  - Condenser coil: For inlet-side cleaning, remove condenser grilles. For outlet-side cleaning, remove condenser fan panel. Unbolt fan from mounting brackets and slide fan outward until lower locking arm drops into position. Pivot fan by lifting fan locking arm.

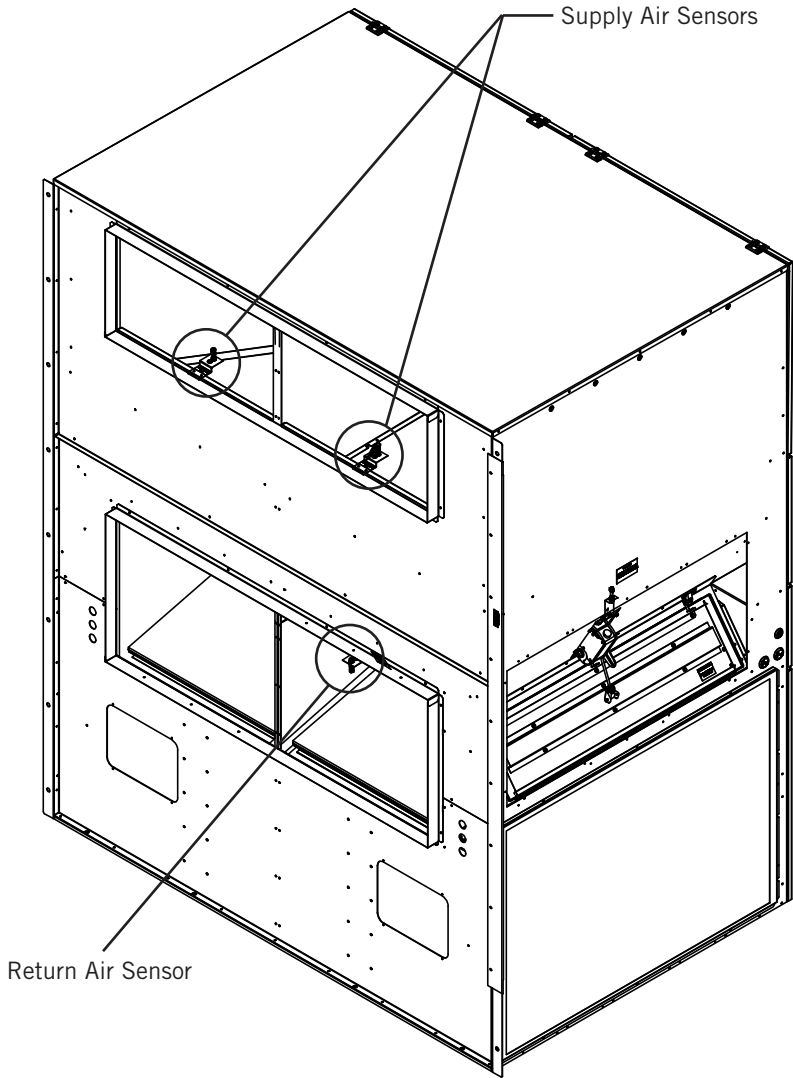
**IMPORTANT:** Be sure to slide fan completely outward before pivoting. Failure to do so could result in damage to the coil.

Follow the coil cleaner manufacturer's directions for necessary safety gear and precautions, as well as for application and use. More than one application may be necessary. Rinse thoroughly.
- Evaporator coil: Open filter access panels and remove filters. Apply specific evaporator cleaner directly to the inlet side of coil, being very careful not to overspray into insulation or surrounding panels and wiring. For outlet-side cleaning, remove supply grille and clean from that direction. Residual cleaner and dissolved debris should drip into the drain pan and leave the unit through the condensate hose. More than one application may be necessary. Rinse thoroughly.
4. Manually spin fan and blower motors to ensure they turn freely. All motors are permanently lubricated, so no oil is necessary.
5. Inspect free cooling damper actuator and linkage.
6. Install new air filters.
7. Inspect the control panel of the system.
  - Look for insect or rodent activity and remove any nesting materials.
  - Manually push contactor closed, observe for movement—contactor points should have minimal discoloration, no spalling or other signs of arcing. Replace if doubtful.
  - Check field and factory wiring for tightness and look for signs of overheating (discoloration of terminals or wire insulation).
8. Ensure that supply and return registers are not obstructed, and more importantly, are not recycling the air to one another. Adjust supply louvers if necessary to direct discharge air away from any direct route to the return grille.
9. Re-assemble wall-mount unit, remembering to fasten fan to mounting brackets. Turn breakers back on.
10. Enable system to LC6000 controller (see latest revision of LC6000 Service Instructions 2100-669).
11. Repeat steps for additional wall-mount units.

**FIGURE 74**  
Sensors and Peripheral Devices



**FIGURE 75**  
**Supply and Return Air Sensors**





## 8301-089 Outdoor Temperature/Humidity Sensor

### 8301-089 Sensor Connections

This unit utilizes a two-wire 4-10mA signal from the 8301-089 sensor to communicate outdoor humidity and a 10K $\Omega$  Type III (AN) thermocouple from the 8301-089 sensor to communicate outdoor temperature. The humidity sensor is connected to the sensor control board via the J13 connector. The thermocouple wires are loose in the sensor housing and require a butt splice connector or wire nut to connect

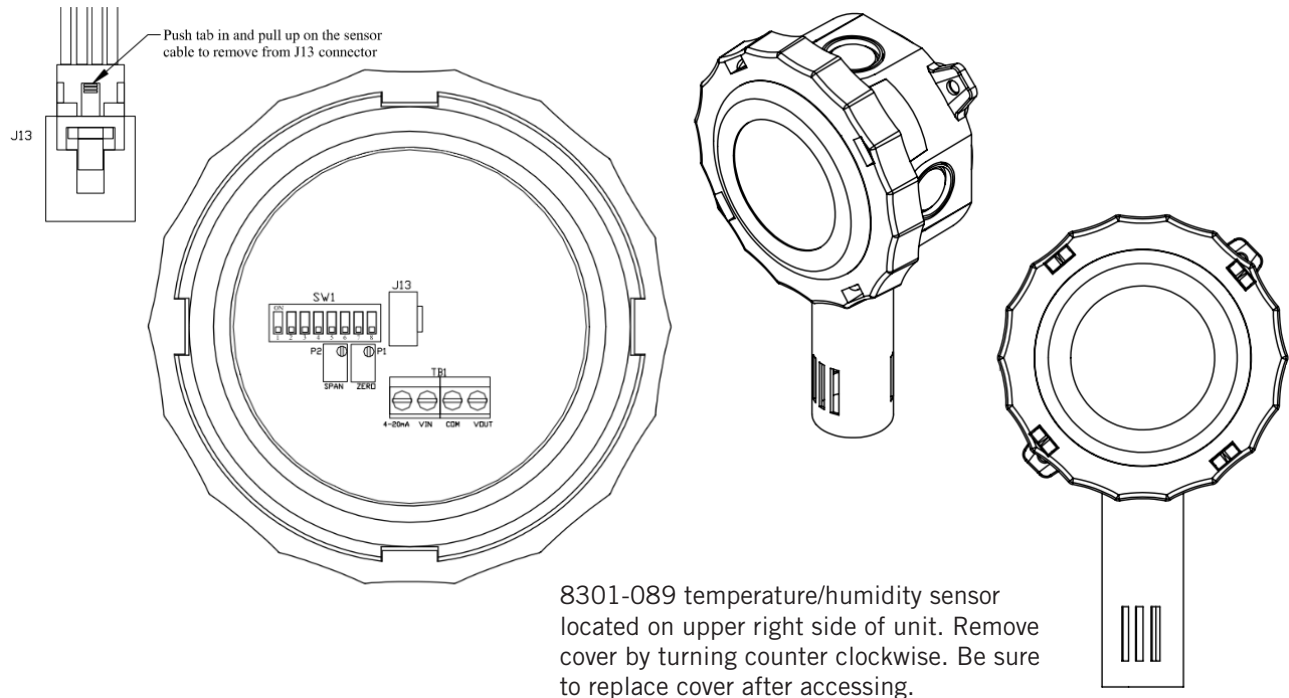
to the main unit wiring harness. See Figures 76 and 77 for sensor wiring and terminal location.

Tables 13 and 14 on pages 51 and 53 are correlation charts for troubleshooting the sensor with a test meter:

Table 13: Temperature to Thermocouple Resistance

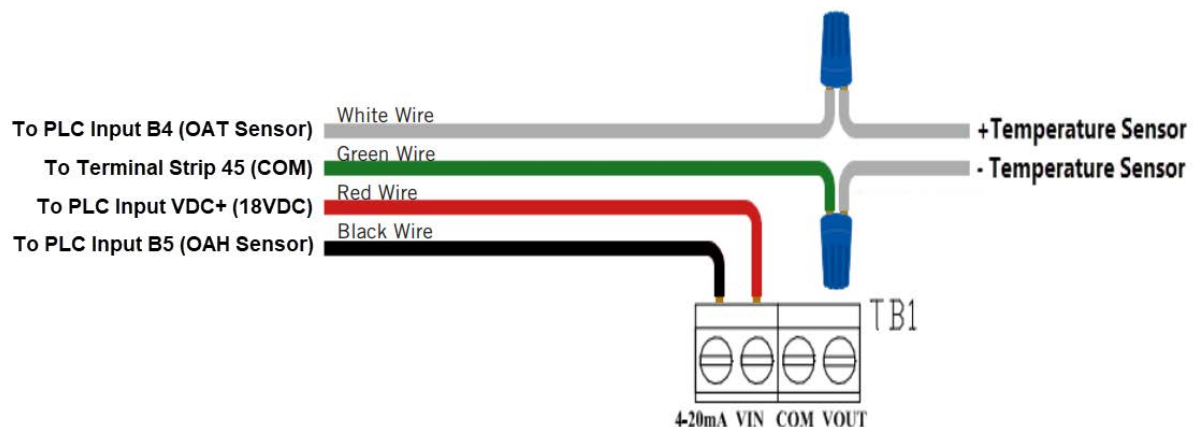
Table 14: Relative Humidity to Humidity Sensor Current Output

**FIGURE 76**  
8301-089 Sensor Electrical Connections and DIP Switches



8301-089 temperature/humidity sensor located on upper right side of unit. Remove cover by turning counter clockwise. Be sure to replace cover after accessing.

**FIGURE 77**  
8301-089 Sensor Terminal Connections

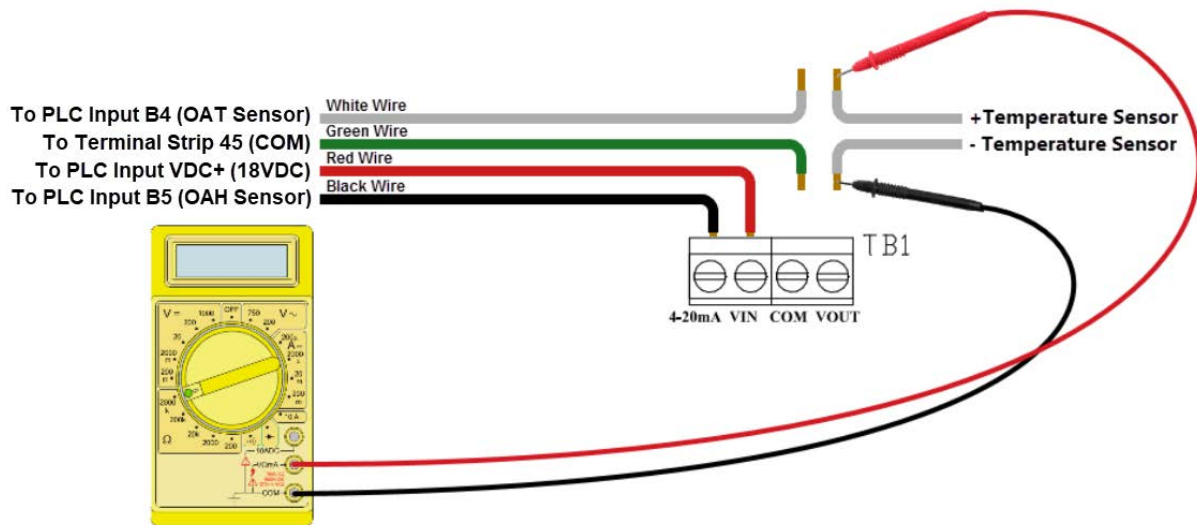


## 8301-089 Outdoor Temperature Sensor Troubleshooting

To verify sensor operation:

1. Remove lid from outdoor temperature/humidity sensor.
2. Remove wire nuts from green and white wires (see Figure 77).
3. Use a temperature probe (preferred method) or local weather data to find ambient temperature conditions.
4. Using an ohmmeter or resistance mode on a multimeter, measure resistance across white leads leading to the temperature sensor (see Figure 78).
5. Cross reference readings with Table 13.
  - A. If readings are consistent with reference temperature, check wiring or offset in PLC if outdoor temp value on PLC does not match.
  - B. If readings do not match, replace sensor.

**FIGURE 78**  
**8301-089 Sensor: Temperature Probe Troubleshooting**



**TABLE 13**  
**8301-089 Sensor: Temperature/Resistance**

Temperature		Resistance	Temperature		Resistance	Temperature		Resistance	Temperature		Resistance
F	C	Ω	F	C	Ω	F	C	Ω	F	C	Ω
-25	-31.7	148,452.94	13	-10.6	48,892.46	51	10.6	18,337.51	89	31.7	7679.76
-24	-31.1	143,910.37	14	-10.0	47,571.97	52	11.1	17,898.38	90	32.2	7515.86
-23	-30.6	139,521.46	15	-9.4	46,291.29	53	11.7	17,471.09	91	32.8	7355.94
-22	-30.0	135,280.55	16	-8.9	45,049.09	54	12.2	17,055.30	92	33.3	7199.88
-21	-29.4	131,182.22	17	-8.3	43,844.12	55	12.8	16,650.65	93	33.9	7047.59
-20	-28.9	127,221.25	18	-7.8	42,675.14	56	13.3	16,256.82	94	34.4	6898.95
-19	-28.3	123,392.63	19	-7.2	41,540.99	57	13.9	15,873.48	95	35.0	6753.88
-18	-27.8	119,691.54	20	-6.7	40,440.51	58	14.4	15,500.34	96	35.6	6612.28
-17	-27.2	116,113.37	21	-6.1	39,372.62	59	15.0	15,137.09	97	36.1	6474.05
-16	-26.7	112,653.66	22	-5.6	38,336.26	60	15.6	14,783.44	98	36.7	6339.11
-15	-26.1	109,308.15	23	-5.0	37,330.40	61	16.1	14,439.11	99	37.2	6207.37
-14	-25.6	106,072.72	24	-4.4	36,354.06	62	16.7	14,103.83	100	37.8	6078.74
-13	-25.0	102,943.44	25	-3.9	35,406.29	63	17.2	13,777.34	101	38.3	5953.15
-12	-24.4	99,916.50	26	-3.3	34,486.17	64	17.8	13,459.38	102	38.9	5830.51
-11	-23.9	96,988.26	27	-2.8	33,592.81	65	18.3	13,149.70	103	39.4	5710.75
-10	-23.3	94,155.21	28	-2.2	32,725.36	66	18.9	12,848.07	104	40.0	5593.78
-9	-22.8	91,413.97	29	-1.7	31,883.00	67	19.4	12,554.26	105	40.6	5479.55
-8	-22.2	88,761.30	30	-1.1	31,064.92	68	20.0	12,268.04	106	41.1	5367.98
-7	-21.7	86,194.07	31	-0.6	30,270.36	69	20.6	11,989.19	107	41.7	5258.99
-6	-21.1	83,709.29	32	0.0	29,498.58	70	21.1	11,717.51	108	42.2	5152.53
-5	-20.6	81,304.06	33	0.6	28,748.85	71	21.7	11,452.79	109	42.8	5048.52
-4	-20.0	78,975.60	34	1.1	28,020.48	72	22.2	11,194.83	110	43.3	4946.91
-3	-19.4	76,721.24	35	1.7	27,312.81	73	22.8	10,943.45	111	43.9	4847.63
-2	-18.9	74,538.41	36	2.2	26,625.18	74	23.3	10,698.45	112	44.4	4750.62
-1	-18.3	72,424.61	37	2.8	25,956.98	75	23.9	10,459.65	113	45.0	4655.83
0	-17.8	70,377.48	38	3.3	25,307.60	76	24.4	10,226.90	114	45.6	4563.20
1	-17.2	68,394.70	39	3.9	24,676.45	77	25.0	10,000.00	115	46.1	4472.67
2	-16.7	66,474.07	40	4.4	24,062.97	78	25.6	9778.81	116	46.7	4384.19
3	-16.1	64,613.46	41	5.0	23,466.62	79	26.1	9563.15	117	47.2	4297.71
4	-15.6	62,810.82	42	5.6	22,886.87	80	26.7	9352.89	118	47.8	4213.18
5	-15.0	61,064.17	43	6.1	22,323.22	81	27.2	9147.86	119	48.3	4130.55
6	-14.4	59,371.62	44	6.7	21,775.16	82	27.8	8947.93	120	48.9	4049.77
7	-13.9	57,731.32	45	7.2	21,242.23	83	28.3	8752.95	121	49.4	3970.79
8	-13.3	56,141.52	46	7.8	20,723.96	84	28.9	8562.79	122	50.0	3893.58
9	-12.8	54,600.50	47	8.3	20,219.91	85	29.4	8377.31	123	50.6	3818.08
10	-12.2	53,106.64	48	8.9	19,729.65	86	30.0	8196.39	124	51.1	3744.26
11	-11.7	51,658.35	49	9.4	19,252.76	87	30.6	8019.91	125	51.7	3672.07
12	-11.1	50,254.11	50	10.0	18,788.84	88	31.1	7847.74			

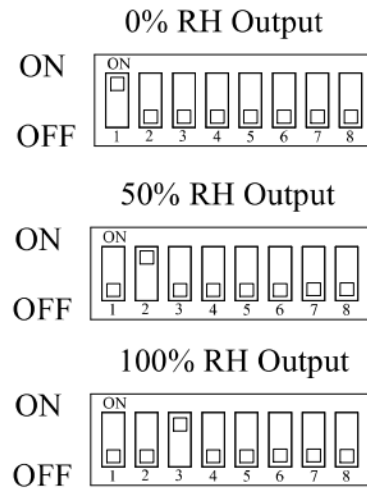
### 8301-089 Humidity Sensor Test Value Outputs

This sensor has the ability to output fixed test signals when testing/troubleshooting sensor operation. These settings are to be used for sensor testing/troubleshooting only and need to be removed before unit can resume normal operation. These settings allow the sensor board to output 0% RH, 50% RH and 100% RH. When these settings are active, the actual humidity sensor is ignored. DIP switches 1, 2 and 3 are used to override the output to a test signal. See Figure 79 for DIP switch/output configuration.

**NOTE:** If any DIP switches are disrupted, they will need to be returned to the off state in order for the humidity sensor to return to normal operation.

**FIGURE 79**  
8301-089 DIP Switch/Output Configuration

### Test Selection Switches (SW1)

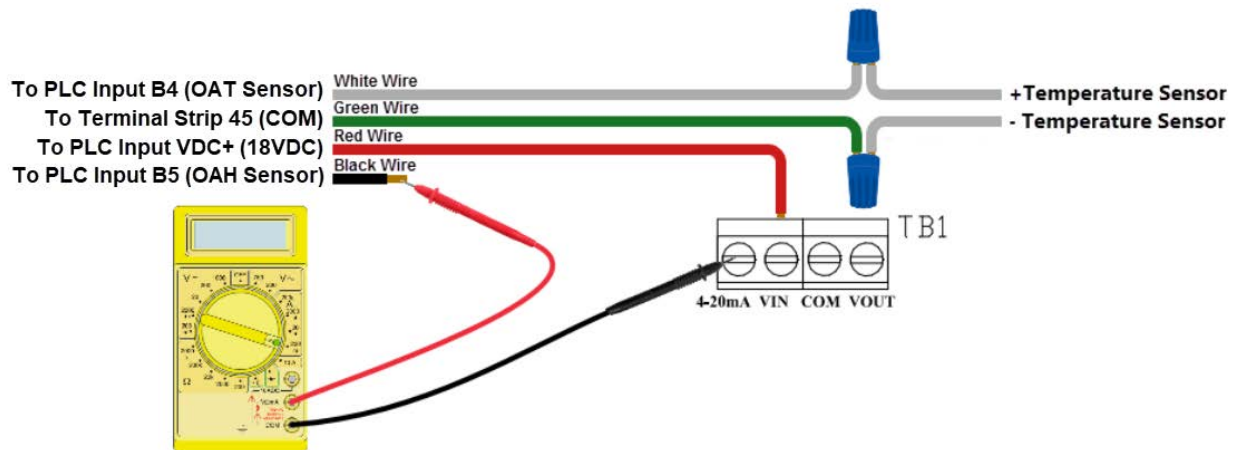


### 8301-089 Outdoor Humidity Sensor Troubleshooting

To verify sensor operation:

1. Remove lid from outdoor temperature/humidity sensor.
2. Loosen and remove black wire from the 4-20 mA input of TB1 (see Figure 77).
3. Use an RH meter (preferred method) or local weather data to find accurate RH reading.
4. Using an ohmmeter or amperage mode on a multimeter, measure the amperage through the black 4-20 mA wire leading to the PLC (see Figure 80).
5. Cross reference readings with Table 14.
  - A. If readings are consistent with reference humidity, verify the DIP switches are all in the off position, check wiring or offset in PLC if outdoor humidity value on PLC does not match.
  - B. If readings do not match, replace sensor.

**FIGURE 80**  
8301-089 Sensor: Humidity Probe Troubleshooting



**TABLE 14**  
**8301-089 Sensor: Humidity/mA**

RH%	mA Output	RH%	mA Output	RH%	mA Output
0	4.000 mA	34	9.440 mA	68	14.880 mA
1	4.160 mA	35	9.600 mA	69	15.040 mA
2	4.320 mA	36	9.760 mA	70	15.200 mA
3	4.480 mA	37	9.920 mA	71	15.360 mA
4	4.640 mA	38	10.080 mA	72	15.520 mA
5	4.800 mA	39	10.240 mA	73	15.680 mA
6	4.960 mA	40	10.400 mA	74	15.840 mA
7	5.120 mA	41	10.560 mA	75	16.000 mA
8	5.280 mA	42	10.720 mA	76	16.160 mA
9	5.440 mA	43	10.880 mA	77	16.320 mA
10	5.600 mA	44	11.040 mA	78	16.480 mA
11	5.760 mA	45	11.200 mA	79	16.640 mA
12	5.920 mA	46	11.360 mA	80	16.800 mA
13	6.080 mA	47	11.520 mA	81	16.960 mA
14	6.240 mA	48	11.680 mA	82	17.120 mA
15	6.400 mA	49	11.840 mA	83	17.280 mA
16	6.560 mA	50	12.000 mA	84	17.440 mA
17	6.720 mA	51	12.160 mA	85	17.600 mA
18	6.880 mA	52	12.320 mA	86	17.760 mA
19	7.040 mA	53	12.480 mA	87	17.920 mA
20	7.200 mA	54	12.640 mA	88	18.080 mA
21	7.360 mA	55	12.800 mA	89	18.240 mA
22	7.520 mA	56	12.960 mA	90	18.400 mA
23	7.680 mA	57	13.120 mA	91	18.560 mA
24	7.840 mA	58	13.280 mA	92	18.720 mA
25	8.000 mA	59	13.440 mA	93	18.880 mA
26	8.160 mA	60	13.600 mA	94	19.040 mA
27	8.320 mA	61	13.760 mA	95	19.200 mA
28	8.480 mA	62	13.920 mA	96	19.360 mA
29	8.640 mA	63	14.080 mA	97	19.520 mA
30	8.800 mA	64	14.240 mA	98	19.680 mA
31	8.960 mA	65	14.400 mA	99	19.840 mA
32	9.120 mA	66	14.560 mA	100	20.000 mA
33	9.280 mA	67	14.720 mA		

**8620-296 Supply Air Sensor/Return Air Sensor/Mixed Air Sensor/  
Suction Sensor/Liquid Sensor**

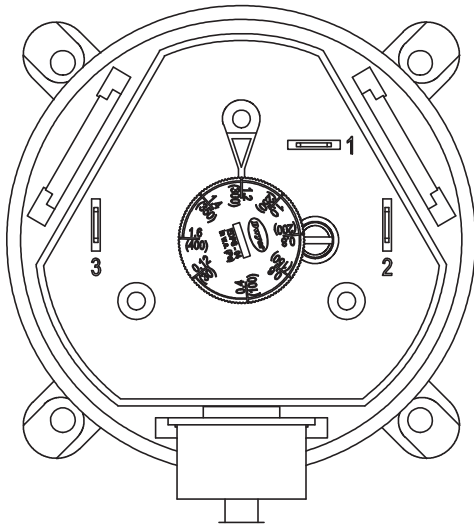


**TABLE 15**  
**8620-296 Sensor: Temperature/Resistance Curve J**

Temperature °F	Resistance Ω	Temperature °F	Resistance Ω	Temperature °F	Resistance Ω	Temperature °F	Resistance Ω
-25.0	196871	13.0	56985	53.0	19374	89.0	7507
-24.0	190099	14.0	55284	52.0	18867	90.0	7334
-23.0	183585	15.0	53640	53.0	18375	91.0	7165
-22.0	177318	16.0	52051	54.0	17989	92.0	7000
-21.0	171289	17.0	50514	55.0	17434	93.0	6840
-20.0	165487	18.0	49028	56.0	16984	94.0	6683
-19.0	159904	19.0	47590	57.0	16547	95.0	6531
-18.0	154529	20.0	46200	58.0	16122	96.0	6383
-17.0	149355	21.0	44855	59.0	15710	97.0	6239
-16.0	144374	22.0	43554	60.0	15310	98.0	6098
-15.0	139576	23.0	42295	61.0	14921	99.0	5961
-14.0	134956	24.0	41077	62.0	14544	100.0	5827
-13.0	130506	25.0	39898	63.0	14177	101.0	5697
-12.0	126219	26.0	38757	64.0	13820	102.0	5570
-11.0	122089	27.0	37652	65.0	13474	103.0	5446
-10.0	118108	28.0	36583	66.0	13137	104.0	5326
-9.0	114272	29.0	35548	67.0	12810	105.0	5208
-8.0	110575	30.0	34545	68.0	12492	106.0	5094
-7.0	107010	31.0	33574	69.0	12183	107.0	4982
-6.0	103574	32.0	32634	70.0	11883	108.0	4873
-5.0	100260	33.0	31723	71.0	11591	109.0	4767
-4.0	97064	34.0	30840	72.0	11307	110.0	4663
-3.0	93981	35.0	29986	73.0	11031	111.0	4562
-2.0	91008	36.0	29157	74.0	10762	112.0	4464
-1.0	88139	37.0	28355	75.0	10501	113.0	4367
0.0	85371	38.0	27577	76.0	10247	114.0	4274
1.0	82699	39.0	26823	77.0	10000	115.0	4182
2.0	80121	40.0	26092	78.0	9760	116.0	4093
3.0	77632	41.0	25383	79.0	9526	117.0	4006
4.0	75230	42.0	24696	80.0	9299	118.0	3921
5.0	72910	43.0	24030	81.0	9077	119.0	3838
6.0	70670	44.0	23384	82.0	8862	120.0	3757
7.0	68507	45.0	22758	83.0	8653	121.0	3678
8.0	66418	46.0	22150	84.0	8449	122.0	3601
9.0	64399	47.0	21561	85.0	8250	123.0	3526
10.0	62449	48.0	20989	86.0	8057	124.0	3452
11.0	60565	49.0	20435	87.0	7869		
12.0	58745	50.0	19896	88.0	7686		

# 8301-057 Blower Status Switch/Dirty Filter Switch

**FIGURE 81**  
8301-057 Air Differential Switch

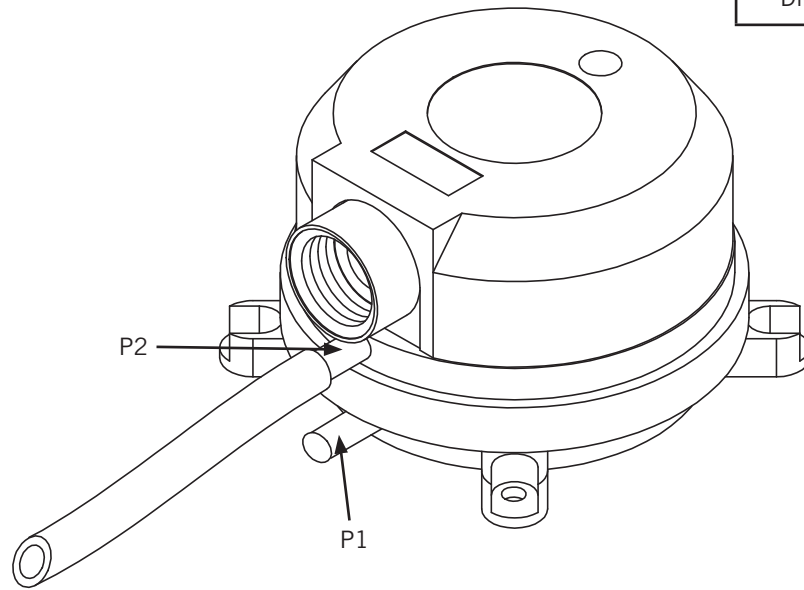


**Terminals**

- 1 – Normally Closed
- 2 – Normally Open
- 3 – Common

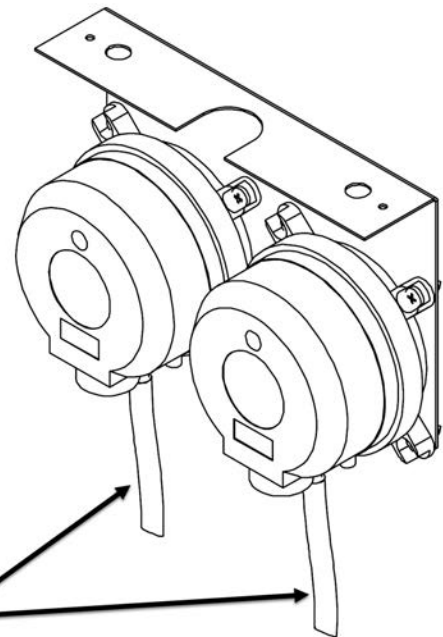
**NOTE:** Contact position is in resting state.

W180 Switch Settings	
Left and Right Blower Status Switches	0.40
Left and Right Dirty Filter Switches	1.40



Connect hose to P2

Hoses need to be connected to the P2 port (port closest to front)



## Compressor Solenoid

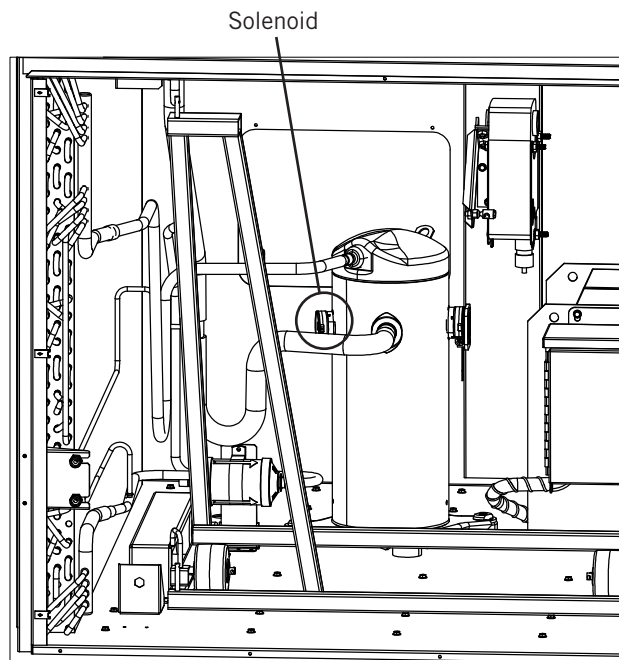
A nominal 24-volt direct current coil activates the internal compressor solenoid. The input control circuit voltage must be 18 to 28 VAC. The coil power requirement is 20 VAC. The external electrical connection is made with a molded plug assembly. This plug contains a full wave rectifier to supply direct current to the unloader coil.

### Compressor Solenoid Test Procedures

If it is suspected that the unloader is not working, the following methods may be used to verify operation.

1. Operate the system and measure compressor amperage. Cycle the compressor solenoid on and off at 10-second intervals. The compressor amperage should go up or down at least 25%.
2. If Step 1 does not give the expected results, shut unit off. Apply 18 to 28 VAC to the solenoid molded plug leads and listen for a click as the solenoid pulls in. Remove power and listen for another click as the solenoid returns to its original position.
3. If clicks can't be heard, shut off power, remove the control circuit molded plug from the compressor and measure the solenoid coil resistance (see Table 16).

**FIGURE 82**  
Compressor Solenoid Location



**TABLE 16**  
Solenoid Coil Resistance

Compressor Model	Solenoid Ohms
ZPS***K5	350 $\Omega$ or 1640 $\Omega$
ZPS***K6 ZPS***K7	1640 $\Omega$

4. Next, check the molded plug.

**Voltage Check:** Apply control voltage to the plug wires (18 to 28 VAC). The measured **DC** voltage at the female connectors in the plug should be around 15 to 27 VDC.

**Resistance Check:** Measure the resistance from the end of one molded plug lead to either of the two female connectors in the plug. One of the connectors should read close to 0 ohms, while the other should read infinity. Repeat with other wire. The same female connector as before should read zero, while the other connector again reads infinity. Reverse polarity on the ohmmeter leads and repeat. The female connector that read infinity previously should now read close to 0 ohms.

Replace plug if either of these test methods does not show the desired results.

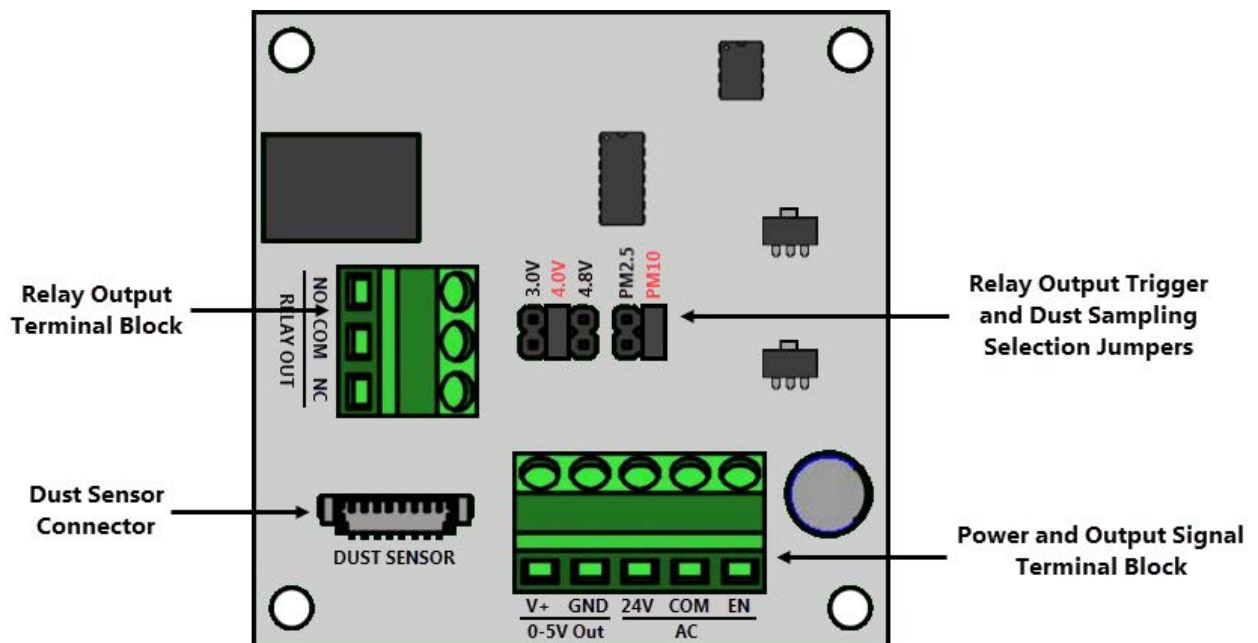


## 8612-064 Dust (Particulate) Sensor Control Board

### 8612-064 Control Board Output Signal Not Responsive

1. With a voltmeter, verify 24VAC present across 24VAC pin terminals.
  - A. If 24VAC is not present, trace back wires to source.
2. Inspect and re-seat the dust sensor communication cable.
  - A. Carefully remove the dust sensor communication cable from the dust sensor connector on the dust sensor alarm board and the dust sensor (see Figure 83).
  - B. Inspect communication cable for the following:
    - i. Wires pulled out of the connectors.
    - ii. Scars in insulation exposing bare wire.
  - C. If communication cable is damaged:
    - i. Replace communication cable.
  - D. If communication cable is not damaged:
    - i. Carefully reconnect the dust sensor communication cable to the dust sensor connector on the dust sensor alarm board and the dust sensor.

**FIGURE 83**  
8612-064 Dust Sensor Alarm Board



## 8301-091 Dust (Particulate) Sensor

The following measurements are taken across V+ and GND on Dust Sensor Alarm




**TABLE 17**  
**8301-091 Sensor: Dust/Volts**

Dust	Signal	Dust	Signal	Dust	Signal
$\mu\text{g}/\text{m}^3$	Vdc	$\mu\text{g}/\text{m}^3$	Vdc	$\mu\text{g}/\text{m}^3$	Vdc
0	0.10	34	1.77	68	3.43
1	0.15	35	1.82	69	3.48
2	0.20	36	1.86	70	3.53
3	0.25	37	1.91	71	3.58
4	0.30	38	1.96	72	3.63
5	0.35	39	2.01	73	3.68
6	0.39	40	2.06	74	3.73
7	0.44	41	2.11	75	3.78
8	0.49	42	2.16	76	3.82
9	0.54	43	2.21	77	3.87
10	0.59	44	2.26	78	3.92
11	0.64	45	2.31	79	3.97
12	0.69	46	2.35	80	4.02
13	0.74	47	2.40	81	4.07
14	0.79	48	2.45	82	4.12
15	0.84	49	2.50	83	4.17
16	0.88	50	2.55	84	4.22
17	0.93	51	2.60	85	4.27
18	0.98	52	2.65	86	4.31
19	1.03	53	2.70	87	4.36
20	1.08	54	2.75	88	4.41
21	1.13	55	2.80	89	4.46
22	1.18	56	2.84	90	4.51
23	1.23	57	2.89	91	4.56
24	1.28	58	2.94	92	4.61
25	1.33	59	2.99	93	4.66
26	1.37	60	3.04	94	4.71
27	1.42	61	3.09	95	4.76
28	1.47	62	3.14	96	4.80
29	1.52	63	3.19	97	4.85
30	1.57	64	3.24	98	4.90
31	1.62	65	3.29	99	4.95
32	1.67	66	3.33	100	5.00
33	1.72	67	3.38		

## Variable Speed Blower/Condenser Fan

FIGURE 84  
Fan Terminals



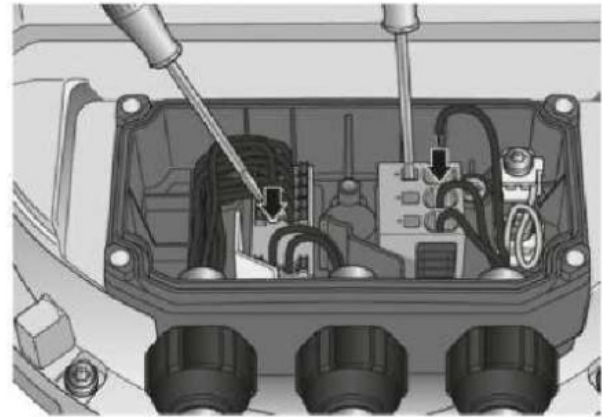
# WARNING

**Electrical shock hazard.**

**Live terminals and connections even when device is turned off.**

**Wait 5 minutes after power has been removed from unit before disconnecting the voltage to the blower/fan motor as internal buss voltage may still be present.**

**Failure to do so could result in electric shock or death.**

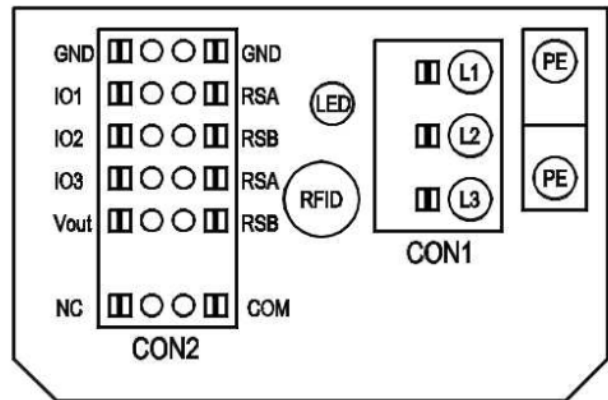


### Maintenance

**CAUTION:** If control voltage or a stored speed value are still applied during power reset, motor may start automatically.

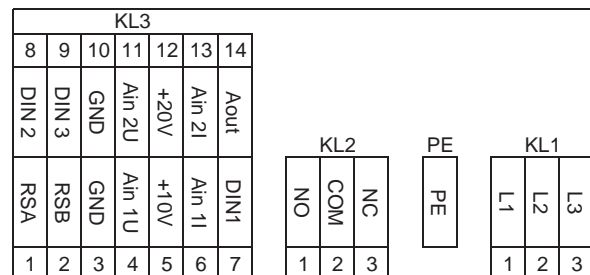
- Keep out of device danger zones.
- When working on/around the fan/blower, switch off line voltage to the unit, ensuring that it cannot be switched back on inadvertently, and wait 5 minutes before removing terminal covers.
- Wait until fan/blower comes to a complete stop before entering areas.
- After work is performed, verify all tools have been removed from unit and specifically the rotational area of the fan/blower.

Gen3 Motor Terminal Box



Connector	Terminal	Description
CON1	L1	Line Power Phase 1
CON1	L2	Line Power Phase 2
CON1	L3	Line Power Phase 3
Housing	PE	Line Power Ground Terminal
CON2	RSA	Modbus +
CON2	RSB	Modbus -
CON2	GND	Control Ground Terminal
Housing	LED	Motor Status LED

Gen2 Motor Terminal Box



**TABLE 18**  
**Blower/Condenser Fan Troubleshooting**

Issue	Possible Cause	Possible Remedy
Impeller/fan not running smoothly	Imbalance in rotating parts	Clean the device (make sure weight clips are not removed during cleaning); replace if imbalance persists after cleaning.
Motor not turning	Mechanical blockage	Switch off unit, isolate from power supply and remove blockage.
	Line voltage faulty	Check line voltage, restore power supply. <b>WARNING: Line Voltage error resets automatically and motor will start without warning.</b>
	Faulty connection	Switch off, isolate from power supply and correct connection. See connection table on page 59.
	Broken motor winding	Replace motor.
	Inadequate cooling	Allow motor to cool down, clean or improve cooling.
	High ambient temperature	Allow motor to cool down.
	Impermissible operating point (e.g., back pressure too high)	Correct static issue, allow motor to cool down.

**LED Warning/Status Codes**

The LED shows the blower/fan motor status with various colors and flash codes and is visible through a small window on the terminal cover of the blower/fan assembly.

Green: No warning of fault.

Orange: Warning. Device is operating out of range but no user action is required.

Red (flashing): There is at least one fault. Flash codes are displayed as on/off pulse at 2Hz. Each code is followed by a 3-second pause. Multiple flash codes will be displayed in succession.

**TABLE 19**  
**Blower/Condenser Fan Motor Flash Codes**

# of Pulses	Motor Status	Manual Reset Required	Possible Cause	Possible Remedy
1	Phase Failure/Line Under Voltage	No	Missing phase/poor line voltage quality	Check line voltage.
3	Inverter Output Overheating	Yes	Dirty electronics housing	Clean inverter housing/improve cooling.
4	Communication Error	No	External power supplied to V out for setting parameters (internal error)	Remove power to unit. Wait. Switch power back on.
6	Motor Overheating	Yes	-	-
7	Hall Sensor Fault	Yes	Internal error	Remove power to unit. Wait. Switch power back on.
8	Motor Locked	No	Mechanical blockage	Remove power. Verify rotor is free to turn. Re-apply power and verify operation.
9	Speed Limit Exceeded	No	-	-
11	Rotor Position Sensor Calibration Error	No	Rotor position sensor needs calibration	Replace and return to manufacturer.
13	DC-Link Under Voltage	No	Line voltage incorrect	Check applied line voltage to motor.

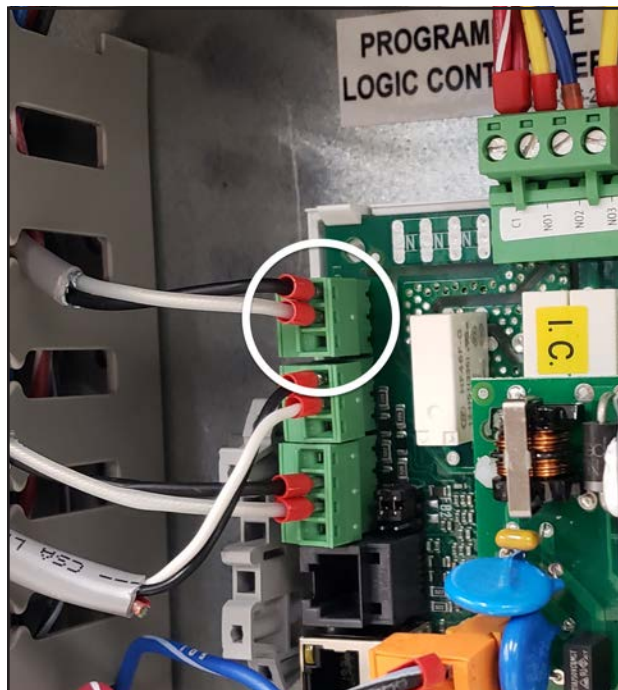
## Modbus Troubleshooting

Use the following instructions if alarm 96, 97, 99, 101 or 103 occurs (see **Alarm Index** on page 64).

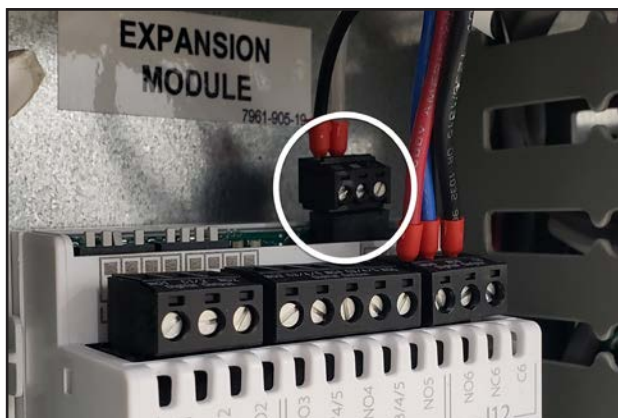
If communication to a specific device is lost, first verify that the polarity of the wires are correct and wires are securely connected to the specified terminal.

- For controller (PLC board) and controller expansion (c.pCOe): The clear/white wire should land on the positive terminal and the black wire should land on the negative terminal (see Figures 85 and 86).

**FIGURE 85**  
PLC Communication Wires

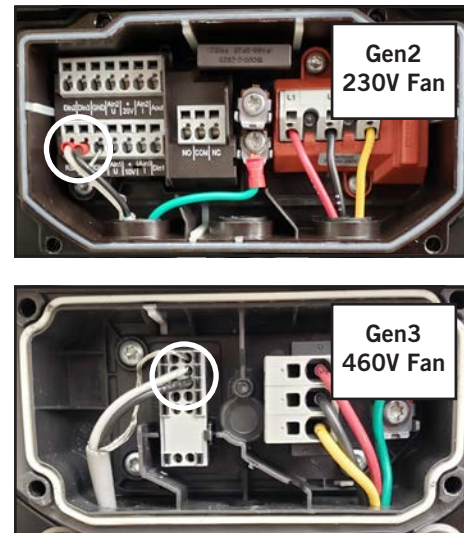


**FIGURE 86**  
Expansion Module (c.pCOe) Communication Wires



- For the blower(s) and condenser fan(s): The clear/white wire should land on the RSA terminal and the black wire should land on the RSB terminal (See Figure 87). Motor generation is displayed on fan/blower screens (see Figures 91 and 92).

**FIGURE 87**  
Blower/Condenser Fan Communication Wires



**NOTE:** Blower terminals are not accessible while installed in unit. To verify polarity and communication, see **Blower Communication Failure** on page 62.

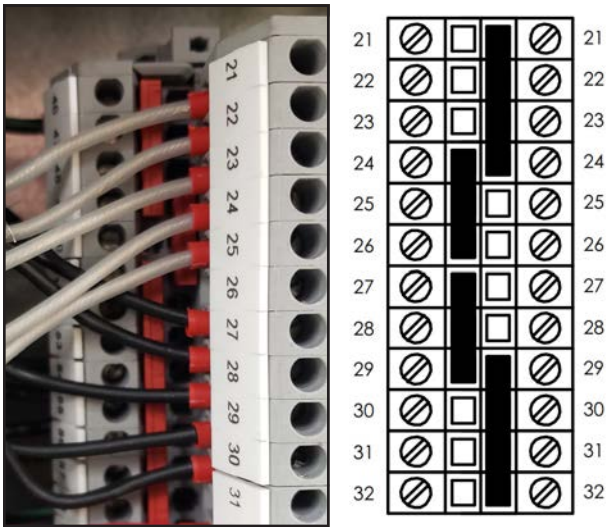
- Table 20 shows where the communication wire for each Modbus device lands on the terminal block. Terminals 21-26 should only have clear/white wires landed on them and terminals 27-32 should only have black wires landed on them (see Figure 88).

**TABLE 20**  
Modbus Device Communication Wires

Control Panel Terminal	Modbus Device Terminal	Modbus Device
21	FB +	Main Controller (PLC)
27	FB -	
22	J6 Tx/Rx +	Controller Expansion (c.pCOe)
28	J6 Tx/Rx -	
23	RSA	Fan 2
29	RSB	Blower 2
24	RSA	
30	RSB	Fan 1
25	RSA	
31	RSB	Blower 1
26	RSA	
32	RSB	

**NOTE:** Shield cables should only be landed at the Modbus device in a specific shield terminal or ground terminal.

**FIGURE 88**  
Communication Wires in Terminal Block



Verify the terminal block jumpers are placed correctly as shown above. Terminals 21-26 should all be bonded together and terminals 27-32 should all be bonded together.

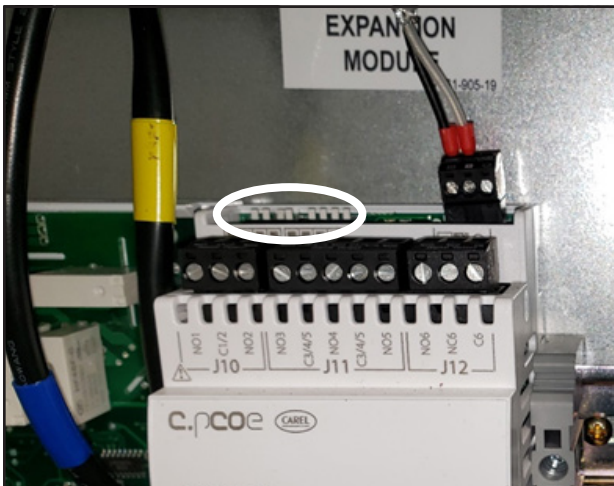
If problem still persists after verifying correct wiring and polarity, proceed to the next steps.

**NOTE:** The following steps are only for single communication alarms at specific devices. If there are multiple devices with communication failures, the issue is either that polarity of the wiring is incorrect, the jumpers in the terminal block are incorrect or the communication port on the PLC board is damaged.

**c.pCOe Communication Failure**

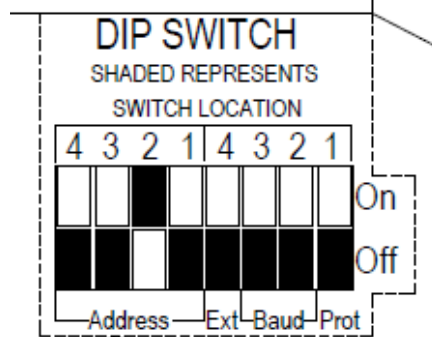
1. Locate the addressing DIP switches on the c.pCOe (see Figure 89).

**FIGURE 89**  
DIP Switch Location



2. Verify the correct DIP switch settings on the c.pCOe (see Figure 90).

**FIGURE 90**  
Correct DIP Switch Settings

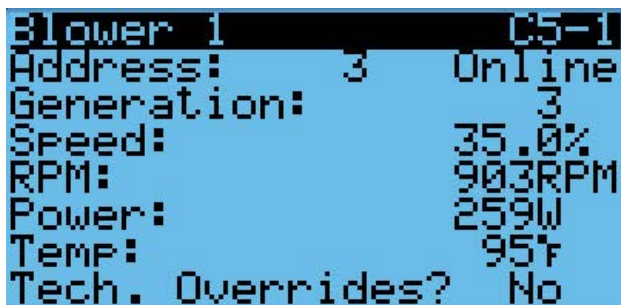


3. If problem persists, verify 24VAC power to c.pCOe, disconnect communication plug from c.pCOe and disconnect wires from terminal block. Verify continuity from end to end and then verify there are no shorts to ground.
4. To verify the expansion module (C.PCOe) is faulty, the communication wires should be isolated from the blower and condenser fan and only connected to the PLC to establish if communication is possible.  
  - c.pCOe Tx+/Rx+ wired to PLC FB+
  - c.pCOe Tx-/Rx- wired to PLC FB-
5. If problem persists after the previous steps, replace c.pCOe.

**Blower Communication Failure**

For the following steps, use the TEC-EYE to view the Modbus status of the blower. This screen is accessible in the I/O Menu under Fans/Blowers (see Figure 91).

**FIGURE 91**  
TEC-EYE Blower 1 Screen



1. Due to the inability to open the blower motor terminal access panel while in the unit, swap the polarity of the communication wires for the effected blower.

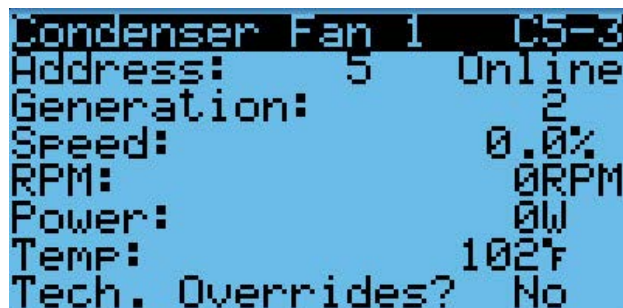
Blower 1: Terminals 26 and 32  
 Blower 2: Terminals 24 and 30

2. If the blower remains offline, the blower must be removed for wiring verification and/or replacement.
  - A. Remove blower terminal access cover.
  - B. Verify high voltage to blower on terminals L1, L2 and L3 with a volt meter.
  - C. If incorrect or no voltage to blower, fix the wiring issue and verify communication.
3. If high voltage is present and correct, check communication wires for short, open or grounded circuits. If a wiring problem is found, make corrections, re-install and verify communication.
4. If no problems are found, replace blower motor.

#### Condenser Fan Communication Failure

For the following steps, use the TEC-EYE to view the Modbus status of the condenser fan. This screen is accessible in the I/O Menu under Fans/Blowers (see Figure 92).

**FIGURE 92**  
**TEC-EYE Condenser Fan 1 Screen**



1. Remove condenser fan terminal access cover (if not already done).
2. Verify high voltage to condenser fan on terminals L1, L2 and L3 with a volt meter.
  - A. If incorrect or no voltage to condenser fan, fix the wiring issue and verify communication.
3. If high voltage is present and correct, check communication wires for short, open or grounded circuits. If a wiring problem is found, make corrections, re-install and verify communication.
4. If no problems are found, replace condenser fan.

## Alarm Index

Index	Alarm	Reference (to Manual Section Unless Otherwise Noted)
0	Error in the number of retain memory writings	Call Bard Technical Service
1	Error in retain memory writings	Call Bard Technical Service
2	Circuit 1 Return Air Temperature Sensor Alarm	See Temperature Control section
3	Circuit 1 High Return Air Temperature Alarm	See Temperature Control section
4	Circuit 2 Return Air Temperature Sensor Alarm	See Temperature Control section
5	Circuit 2 High Return Air Temperature Alarm	See Temperature Control section
6	Circuit 1 Mixed Air Temperature Sensor Alarm	See Economizer section
7	Circuit 1 Mixed Air High Temperature	See Economizer section
8	Circuit 1 Mixed Air Low Temperature	See Economizer section
9	Circuit 2 Mixed Air Temperature Sensor Alarm	See Economizer section
10	Circuit 2 Mixed Air High Temperature	See Economizer section
11	Circuit 2 Mixed Air Low Temperature	See Economizer section
12	Circuit 1 Supply Air Temperature Sensor Alarm	See Indoor Airflow section
13	Circuit 1 High Supply Air Temperature Alarm	See Indoor Airflow section
14	Circuit 1 Low Supply Air Temperature Alarm	See Indoor Airflow section
15	Circuit 2 Supply Air Temperature Sensor Alarm	See Indoor Airflow section
16	Circuit 2 High Supply Air Temperature Alarm	See Indoor Airflow section
17	Circuit 2 Low Supply Air Temperature Alarm	See Indoor Airflow section
18	Outdoor Air Temperature Sensor Alarm	See Economizer section
19	Outdoor Air Humidity Sensor Alarm	See Economizer section
20	Circuit 1 Dust Sensor Alarm	See Economizer section
21	Circuit 1 Dust Sensor High Dust Detection Alarm	See Economizer section
22	Circuit 2 Dust Sensor Alarm	See Economizer section
23	Circuit 2 Dust Sensor High Dust Detection Alarm	See Economizer section
24	Circuit 1 Liquid Line Temp Sensor Alarm	See Condenser Fan section
25	Circuit 2 Liquid Line Temp Sensor Alarm	See Condenser Fan section
26	Circuit 1 Liquid Line Pressure Sensor Alarm	See Condenser Fan section
27	Circuit 2 Liquid Line Pressure Sensor Alarm	See Condenser Fan section
28	Circuit 1 Discharge Temp Sensor Alarm	See Condenser Fan section
29	Circuit 2 Discharge Temp Sensor Alarm	See Condenser Fan section
30	Circuit 1 Discharge Pressure Sensor Alarm	See Condenser Fan section
31	Circuit 2 Discharge Pressure Sensor Alarm	See Condenser Fan section
32	Circuit 1 Suction Temperature Sensor Alarm	See Electronic Expansion Valve (EEV) section
33	Circuit 2 Suction Temperature Sensor Alarm	See Electronic Expansion Valve (EEV) section

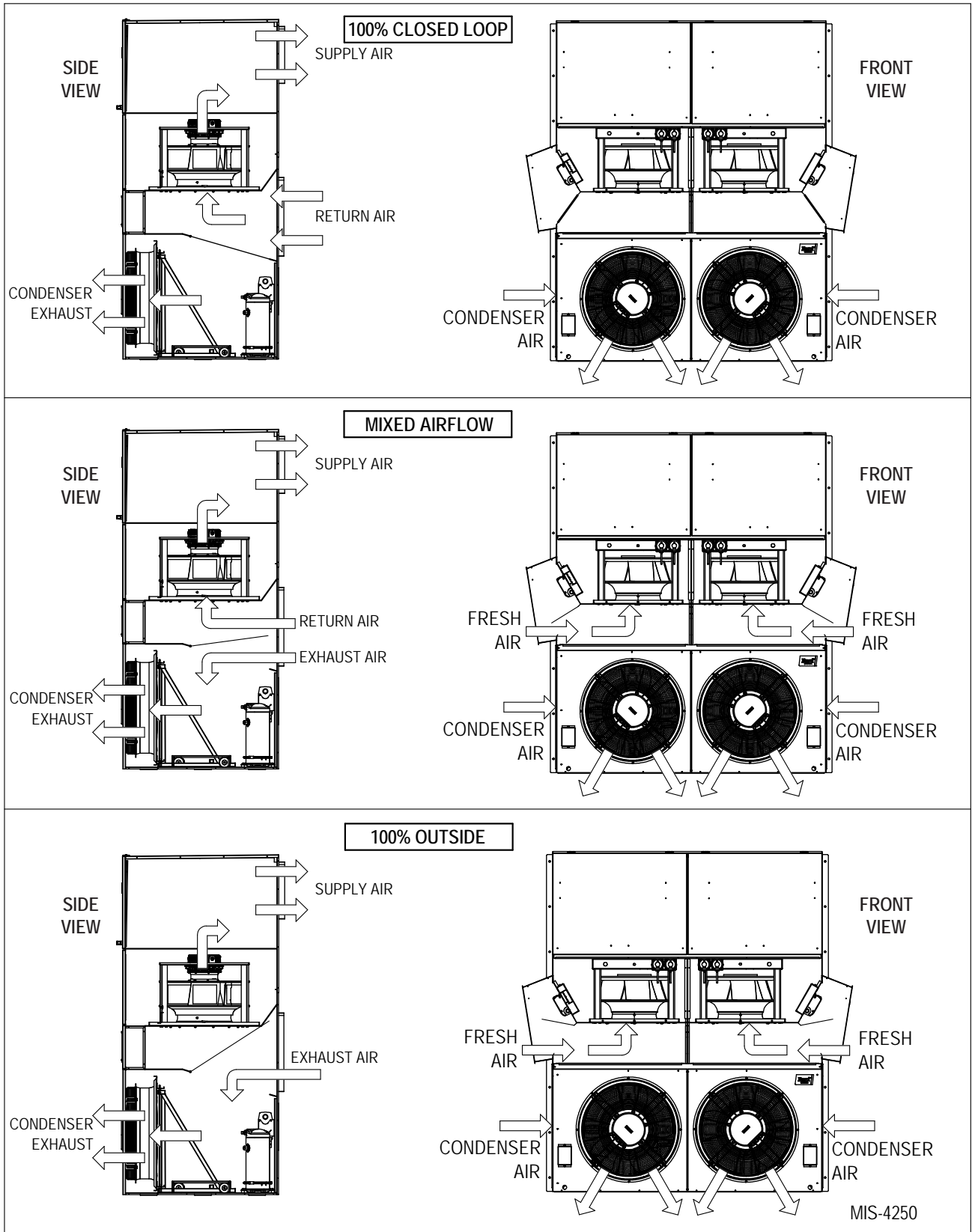


Index	Description	Reference (to Manual Section Unless Otherwise Noted)
34	Circuit 1 Suction Pressure Sensor Alarm	See Electronic Expansion Valve (EEV) section
35	Circuit 2 Suction Pressure Sensor Alarm	See Electronic Expansion Valve (EEV) section
36	Circuit 1 Low Pressure	See Compressor section
37	Circuit 2 Low Pressure	See Compressor section
38	Circuit 1 High Pressure	See Compressor section
39	Circuit 2 High Pressure	See Compressor section
40	Damper 1 Failed to Open	See Economizer section
41	Damper 1 Failed to Close	See Economizer section
42	Damper 2 Failed to Close	See Economizer section
43	Damper 2 Failed to Open	See Economizer section
44	Damper 3 Failed to Open	See Economizer section
45	Damper 3 Failed to Close	See Economizer section
46	Damper 4 Failed to Open	See Economizer section
47	Damper 4 Failed to Close	See Economizer section
50	Circuit 1 Freeze Condition	See Indoor Airflow Operation
51	Circuit 2 Freeze Condition	See Indoor Airflow Operation
52	Circuit 1 Blower Fail Alarm	See Indoor Airflow section
53	Circuit 2 Blower Fail Alarm	See Indoor Airflow section
54	Dirty Filter 1 Alarm	See Indoor Airflow section
55	Dirty Filter 2 Alarm	See Indoor Airflow section
60	Emergency Ventilation Mode Active	See Economizer section
61	Emergency Cooling Mode Active	See Economizer section
62	Extreme High Return Temp Alarm (Heat Cutout)	
63	Unit Disable	See Unit Disable Option section
64	Circuit 1 Power Loss Detected	
65	Circuit 2 Power Loss Detected	
66	Circuit 1 Low SuperHeat	See Electronic Expansion Valve (EEV) section
67	Circuit 1 Low Evaporation Pressure	See Electronic Expansion Valve (EEV) section
68	Circuit 1 High Evaporation Pressure	See Electronic Expansion Valve (EEV) section
69	Circuit 1 High Condenser Temperature	See Electronic Expansion Valve (EEV) section
70	Circuit 1 Low Suction Pressure	See Electronic Expansion Valve (EEV) section
71	Circuit 1 EEV Motor Error	See Electronic Expansion Valve (EEV) section
72	Circuit 1 Self Tuning Error	See Electronic Expansion Valve (EEV) section
73	Circuit 1 Emergency Close	See Electronic Expansion Valve (EEV) section

Continued on page 66

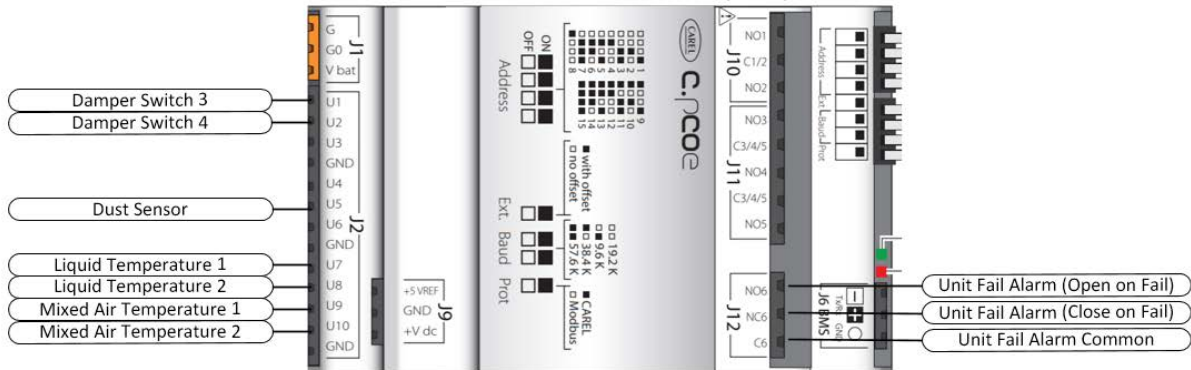
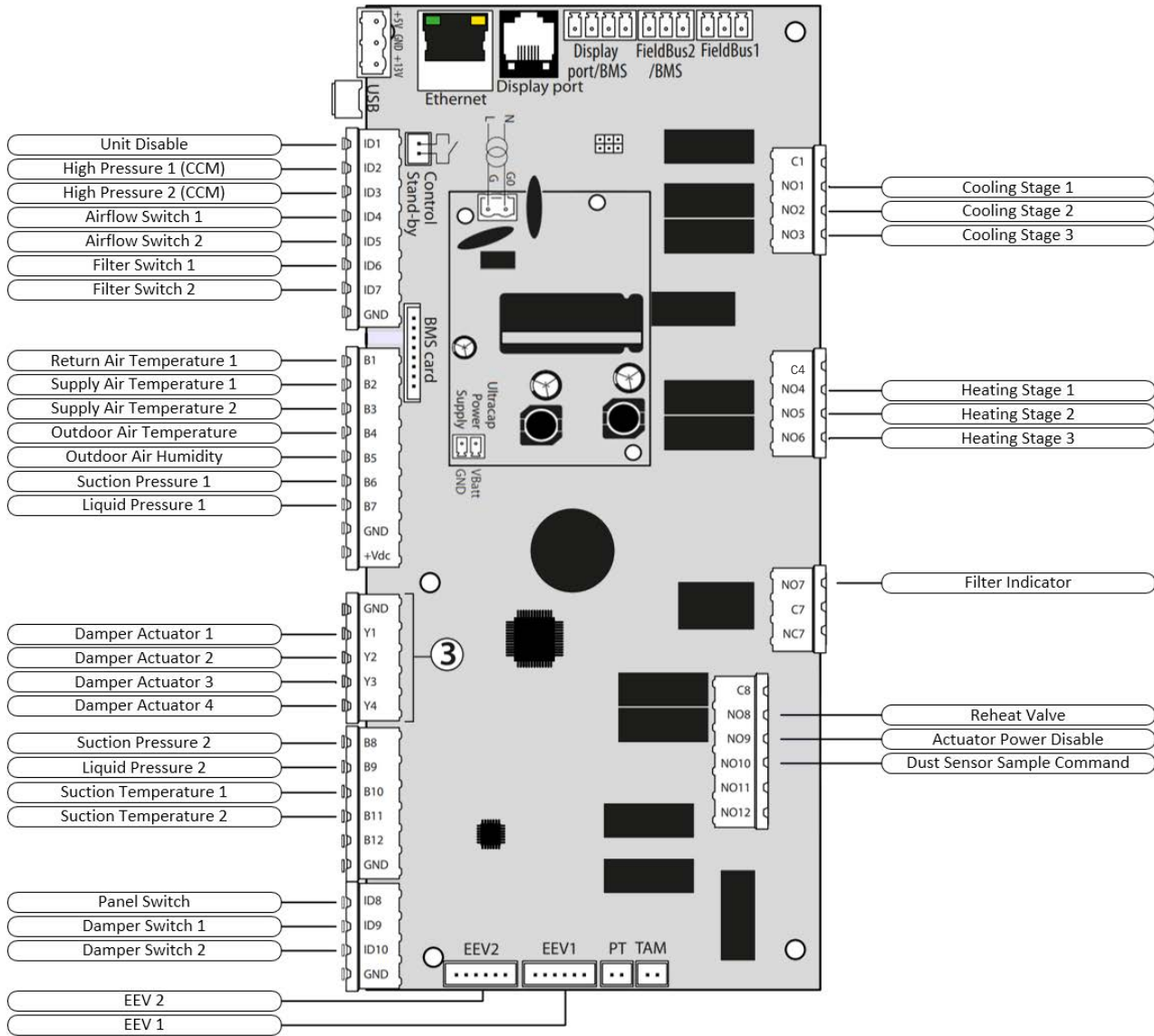
Index	Description	Reference (to Manual Section Unless Otherwise Noted)
74	Circuit 1 High Delta Temperature	See Electronic Expansion Valve (EEV) section
75	Circuit 1 High Delta Pressure	See Electronic Expansion Valve (EEV) section
76	Circuit 1 Range Error	See Electronic Expansion Valve (EEV) section
77	Circuit 1 Service Position Percent	See Electronic Expansion Valve (EEV) section
78	Circuit 1 Valve ID	See Electronic Expansion Valve (EEV) section
79	Circuit 2 Low SuperHeat	See Electronic Expansion Valve (EEV) section
80	Circuit 2 Low Evaporation Pressure	See Electronic Expansion Valve (EEV) section
81	Circuit 2 High Evaporation Pressure	See Electronic Expansion Valve (EEV) section
82	Circuit 2 High Condenser Temperature	See Electronic Expansion Valve (EEV) section
83	Circuit 2 Low Suction Pressure	See Electronic Expansion Valve (EEV) section
84	Circuit 2 EEV Motor Error	See Electronic Expansion Valve (EEV) section
85	Circuit 2 Self Tuning Error	See Electronic Expansion Valve (EEV) section
86	Circuit 2 Emergency Close	See Electronic Expansion Valve (EEV) section
87	Circuit 2 High Delta Temperature	See Electronic Expansion Valve (EEV) section
88	Circuit 2 High Delta Pressure	See Electronic Expansion Valve (EEV) section
89	Circuit 2 Range Error	See Electronic Expansion Valve (EEV) section
90	Circuit 2 Service Position Percent	See Electronic Expansion Valve (EEV) section
91	Circuit 2 Valve ID	See Electronic Expansion Valve (EEV) section
92	Standalone Display Offline	See latest revision of PGD/PGDx manual
93	Standalone Temperature Probe Alarm	See latest revision of PGD/PGDx manual
94	Standalone Humidity Probe Alarm	See latest revision of PGD/PGDx manual
96	c.pCOe Offline	See <b>Modbus Troubleshooting</b>
97	Offline EBM Blower 1	See <b>Modbus Troubleshooting</b>
99	Offline EBM Blower 2	See <b>Modbus Troubleshooting</b>
101	Offline EBM Fan 1	See <b>Modbus Troubleshooting</b>
103	Offline EBM Fan 2	See <b>Modbus Troubleshooting</b>
105	Circuit 1 Low Return Air Temperature Alarm	See Temperature Control section
106	Circuit 2 Low Return Air Temperature Alarm	See Temperature Control section
107	Panel Switch	See Figure 74 (page 47)

**FIGURE 93**  
**Ventilation Airflow Paths**



# I/O Layout

**FIGURE 94**  
I/O Layout



**FIGURE 95**  
I/O Layout

