INSTALLATION INSTRUCTIONS

Partial Flow Commercial Room Ventilator 24 Volt On/Off with Spring Return and Exhaust

Model: CRV-F5



For Use with Bard Wall Mount
Air Conditioner and Heat Pump Models:

W3SAC, W4SAC, W5SAC
W42AC, W48AC, W60AC, W72AC
W42HC, W48HC, W60HC
C36HY, C42HY, C48HY, C60HY



Bard Manufacturing Company, Inc.
Bryan, Ohio 43506
www.bardhvac.com

Manual: 2100-751A
Supersedes: 2100-751
Date: 3-28-23

CONTENTS

General Information3

Commercial Room Ventilator Model Nomenclature ...	3
Unpacking	3
General	3
Commercial Room Ventilator Features.....	3
Description	3
Models	3

Installation of Field-Installed CRV-F5.....4

Basic Installation.....	4
Control System Notes.....	8
Blade Adjustment for Desired Ventilation Air	8
Sequence of Operation	20

Figures

Figure 1 Disconnect Power	4
Figure 2 Remove Side Grilles	4
Figure 3 Remove Blower Door and Control Panel Cover	4
Figure 4 Remove Blank Off Plates (Both Sides)....	5
Figure 5 Remove Exhaust Blank Off Plate	5
Figure 6 Install Gasket	5
Figure 7 Install Exhaust Blade Assembly	5
Figure 8 Remove Air Filters and Low Voltage Control Panel Cover.....	5
Figure 9 Connect 3000-1622 Wire Assembly	6
Figure 10 Install Vent.....	6
Figure 11 Control Plug Centered in Plug Access Opening	6
Figure 12 Connect CRV Power Plug to Control Panel Plug.....	6
Figure 13 Take Blade Out of Shipping Position	6
Figure 14 Set Blade Stop to Adjust Fresh Air	7
Figure 15 Install Intake Sealing Frame and Lower Block Off Plates	7
Figure 16 Install Mist Filters.....	7
Figure 17 Install Bug Screen and Gaskets	7
Figure 18 Programmable Thermostat Connections for CRV with Single Stage Air Conditioners	13
Figure 19 Programmable Thermostat Connections for CRV with 2-Stage Air Conditioners ..	14
Figure 20 Programmable Thermostat Connections for CRV with Heat Pumps.....	15
Figure 21 Non-Programmable Thermostat Connections for CRV with Single Stage Air Conditioners	16
Figure 22 Non-Programmable Thermostat Connections for CRV with 2-Stage Air Conditioners	17
Figure 23 Non-Programmable Thermostat Connections for CRV with Heat Pumps..	18
Figure 24 CRV-F* Wiring Diagram.....	19
Figure 25 Call for Ventilation With or Without Compressor Operation	23
Figure 26 Call for Compressor or Fan Only with Ventilation Off	23

Graphs

Graph 1 W3SAC CRV-F5 Ventilation Delivery	9
Graph 2 W42*C CRV-F5 Ventilation Delivery	9
Graph 3 W48*C and W4SAC CRV-F5 Ventilation Delivery.....	10
Graph 4 W60*C and W5SAC CRV-F5 Ventilation Delivery	10
Graph 5 W72AC CRV-F5 Ventilation Delivery	11
Graph 6 C36H and C42H CRV-F5 Ventilation Delivery	11
Graph 7 C48H and C60H CRV-F5 Ventilation Delivery	12

Tables

Table 1 W**AC and W**HC Unit Operation with M Ventilation Option	20
Table 2 W*SAC Unit Operation with M Ventilation Option.....	21
Table 3 C**HY Unit Operation with M Ventilation Option.....	22

Commercial Room Ventilator Model Nomenclature

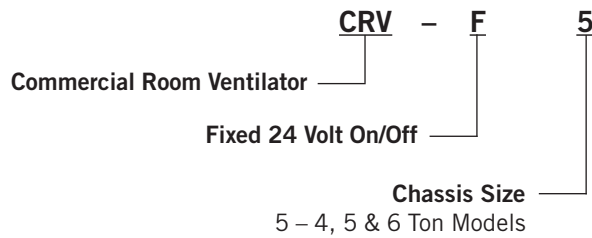

Unpacking

Upon receipt of the equipment be sure to compare the model number found on the shipping label with the accessory identification information on the ordering and shipping document to verify that the correct accessory has been shipped.

Inspect the carton housing of each ventilator as it is received, and before signing the freight bill, verify that all items have been received and that there is no visible damage (check parts list below). Note any shortages or damage on all copies of the freight bill. The receiving party must contact the last carrier immediately, preferably in writing, requesting inspection by the carrier's agent. Concealed damage not discovered until after loading must be reported to the carrier within 15 days of its receipt.

General

The ventilator should only be installed by a trained heating and air conditioning technician. These instructions serve as a guide to the technician installing the ventilator package. They are not intended as a step-by-step procedure with which the mechanically inclined owner can install the package.

The ventilator housing is shipped in one carton which contains the electrical harness, miscellaneous hardware and installation instructions.

Ventilator kit includes:

- (1) CRV-F5 ventilator
- (2) 7003-084 mist filters
- (1) 7003-083 exhaust bug screen
- (2) 539-405 intake sealing frames
- (1) 3000-1622 wire assembly
- (2) 1913-002-0808 8-1/2" foam strips
- (4) 1913-002-0708 7-1/2" foam strips
- (1) 1913-013-2708 foam gasket
- (2) 543-223 lower block off plates
- (12) 1012-086 screws
- (1) 539-414 exhaust damper assembly
- (1) 2100-751A installation instructions

Commercial Room Ventilator Features

- Exhaust air damper – built in with positive closed position. Provides exhaust air capability to prevent pressurization of tight buildings.
- Actuator motor – 24 volt, power open, spring return with built in torque limiting switch.

Description

The CRV-F5 ventilator is designed to be used with the specific models with "letter" revision codes as designated on the front page of this installation instructions manual. The factory-installed vent is denoted by the letter "M" in the unit model nomenclature.

The ventilator is an electromechanical vent system designed to provide fresh air to meet indoor air quality standards.

Models

When installed in the models listed on the front page, the CRV-F5 provides built-in exhaust provisions. When the damper blade opens to bring fresh air in, the damper also opens an exhaust relief. The exhaust air will flow into the condenser section of the unit. The condenser fan will help draw exhaust air out when it is operating with compressor in cooling or heat pump mode.

INSTALLATION OF FIELD-INSTALLED CRV-F5

Basic Installation

WARNING

Electrical shock hazard.
Disconnect remote electrical power supply or supplies before servicing.
Failure to do so could result in electric shock or death.

WARNING

Exposed moving parts.
Disconnect electrical power before servicing.
Failure to do so could result in severe injury or amputation.

CAUTION

Cut hazard.
Wear gloves to avoid contact with sharp edges.
Failure to do so could result in personal injury.

Disconnect all power to unit (see Figure 1).

FIGURE 1
Disconnect Power



Remove both side grilles (see Figure 2).

FIGURE 2
Remove Side Grilles

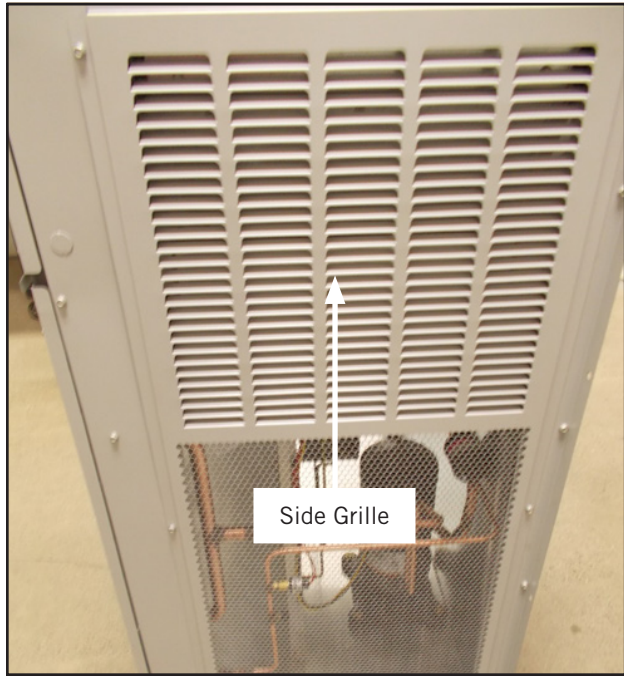

Remove upper blower door and outer control panel cover (see Figure 3).

FIGURE 3
Remove Blower Door and Control Panel Cover

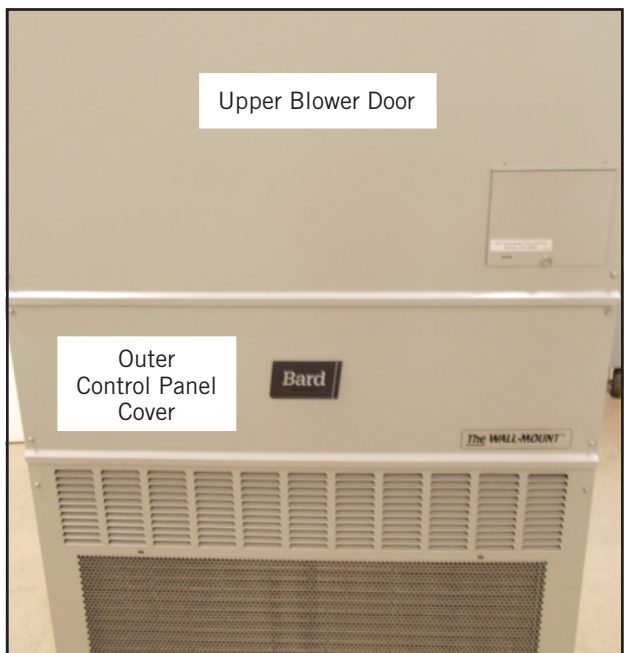

Remove blank off plates on both sides (behind side grilles) and discard (see Figure 4).

FIGURE 4
Remove Blank Off Plates (Both Sides)



Remove exhaust blank off plate through return or through side intake openings (see Figure 5).

FIGURE 5
Remove Exhaust Blank Off Plate

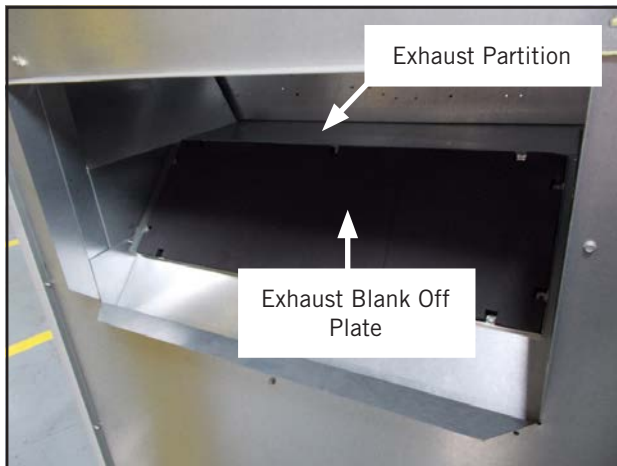

Install 1913-013-2708 gasket 5/8" from bend as shown in Figure 6. Then install exhaust blade assembly using 10 screws (see Figure 7).

FIGURE 6
Install Gasket

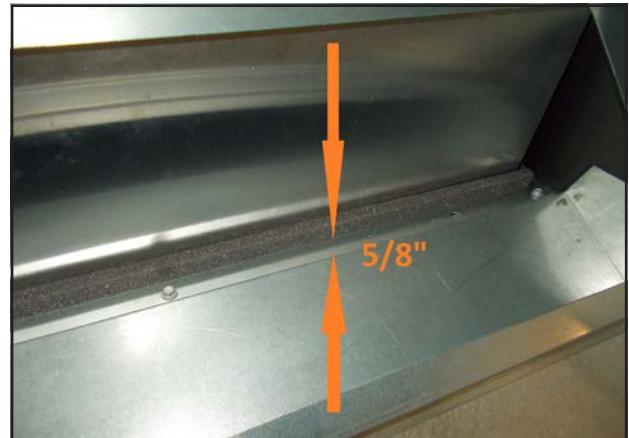
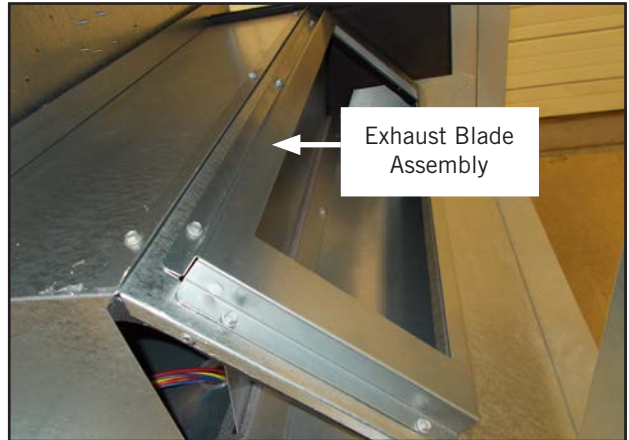
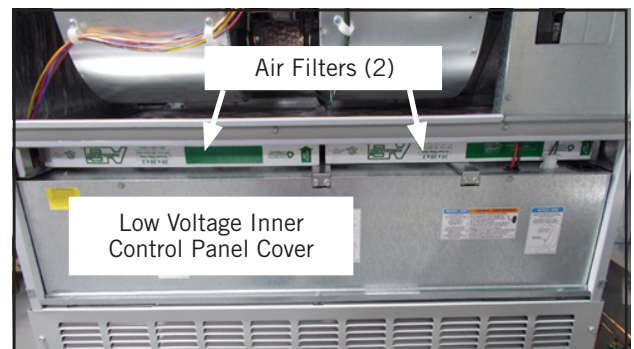

FIGURE 7
Install Exhaust Blade Assembly



Remove both air filters and the low voltage inner control panel cover (see Figure 8).

FIGURE 8
Remove Air Filters and Low Voltage Inner Control Panel Cover



Connect 3000-1622 wire assembly (see Figure 9). Snap the 4 pin connector into the opening next to the low voltage box and plug the 12 pin male connector into the female plug in the low voltage box.

FIGURE 9
Connect 3000-1622 Wire Assembly

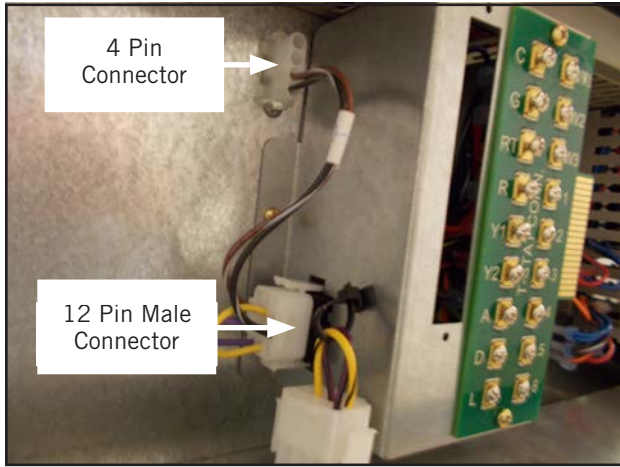

Before installing vent, remove CRV from packaging and verify there is no damage. Install the vent from the side as shown in Figure 10. CRV can be installed from either side.

Set CRV on the exhaust partition (see Figure 5 on page 5) and slide in until flush with the side of the wall mount.

FIGURE 10
Install Vent

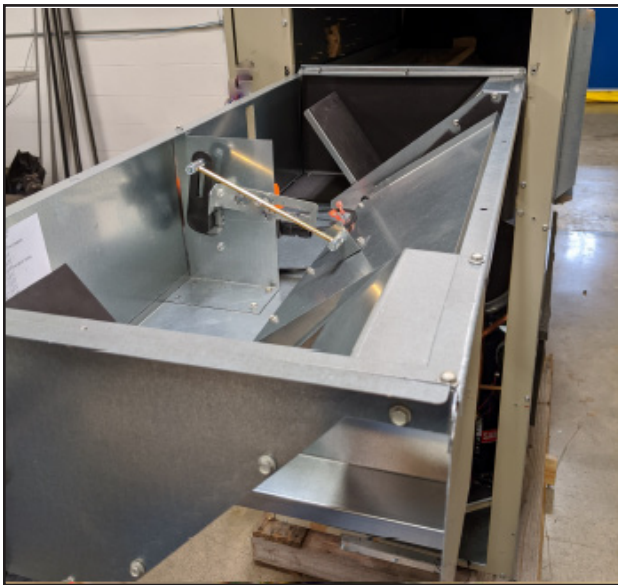

When the CRV is fully installed, the control plug should be centered in the plug access opening on the front panel of the CRV as shown in Figure 11.

FIGURE 11
Control Plug Centered in Plug Access Opening

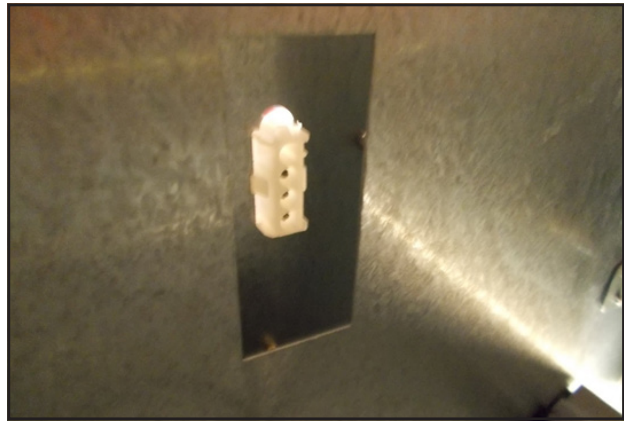

From the front, through the filter opening, plug the CRV power plug into the control panel plug (see Figure 12).

IMPORTANT: Sharp edges—PPE required.

FIGURE 12
Connect CRV Power Plug to Control Panel Plug

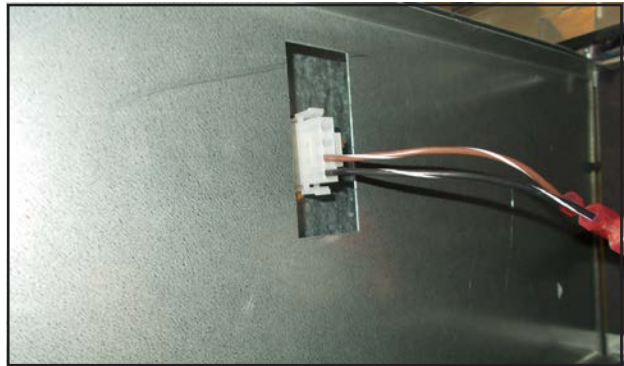

The CRV exhaust blade is fixed in the shipping position by the actuator blade stop (see Figure 13 top and side views). Proceed with caution as the actuator is spring loaded. Remove the blade stop to release the blade.

FIGURE 13
Take Blade Out of Shipping Position

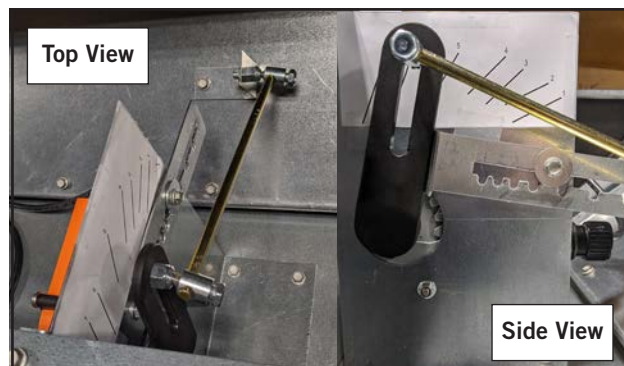

Set blade stop (see Figure 14) using airflow charts found on pages 9 thru 12.

With the exhaust damper blade fully closed, re-install the actuator blade stop. To adjust fresh air amount, loosen the screw on the actuator blade stop and slide the stop to the desired setting. Use the notches in the blade stop and marks on the actuator blade position label to correlate with the airflow settings. Tighten the screw.

FIGURE 14
Set Blade Stop to Adjust Fresh Air Amount



Install the 539-405 intake sealing frame and the 543-223 lower block off plates (both sides) as shown in Figure 15. Install two (2) 1913-002-0708 7-1/2" foam gaskets below the intake sealing frame (both sides).

FIGURE 15
Install Intake Sealing Frame and Lower Block Off Plates

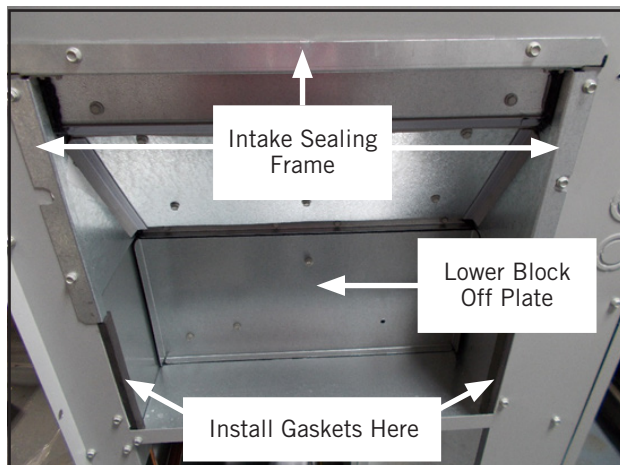

Bend the two (2) sheet metal tabs in the condenser partition up to hold the bottom of the mist eliminator in place.

Install 7003-084 mist filters on both sides (see Figure 16). Then re-install the side grilles removed earlier.

FIGURE 16
Install Mist Filters



Remove the front lower (condenser) grille and bend the two (2) sheet metal tabs in the condenser partition up to hold the bottom of the bug screen in place. Install two (2) 1913-002-0808 8-1/2" foam gaskets to sides of cabinet (see Figure 17). Install the 7003-083 exhaust bug screen. Re-install grille.

FIGURE 17
Install Bug Screen and Gaskets

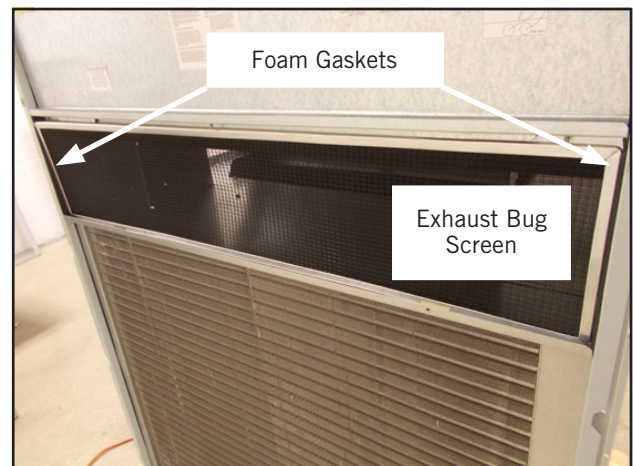

Restore power to unit. The "A" terminal can now be energized to test blade operation. When blade testing is complete, disconnect power.

Install both filters, then re-install the inner control panel cover, outer control panel cover and upper blower door.

Restore power to unit.

Control System Notes

This ventilation package is capable of being set to meet the current ASHRAE specifications for minimum occupied airflow rates.

On/Off Operation

Energizing the A terminal in the low voltage connection box during occupied conditions will drive the fresh air damper to the fixed position selected as shown in Figure 14 on page 7.

Blade Adjustment for Desired Ventilator Air

The amount of ventilation air supplied by the commercial room ventilator is dependant on four factors.

1. Return air duct static pressure drop.
2. Supply air duct static pressure drop.
3. Indoor blower motor speed.
4. Damper blade open position setting.

Refer to the appropriate graph on pages 9, 10, 11 or 12 to determine the blade setting necessary to achieve the ventilation air required.

GRAPH 1
W3SAC CRV-F5 Ventilation Delivery

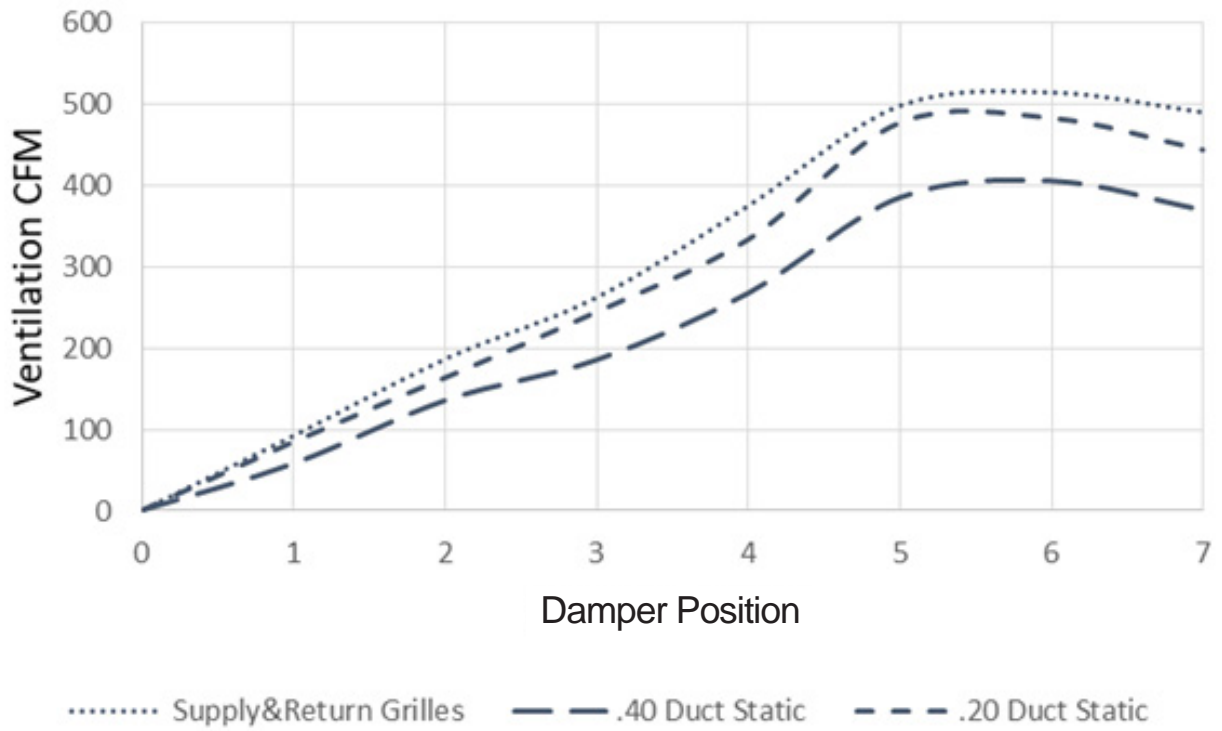

GRAPH 2
W42*C CRV-F5 Ventilation Delivery

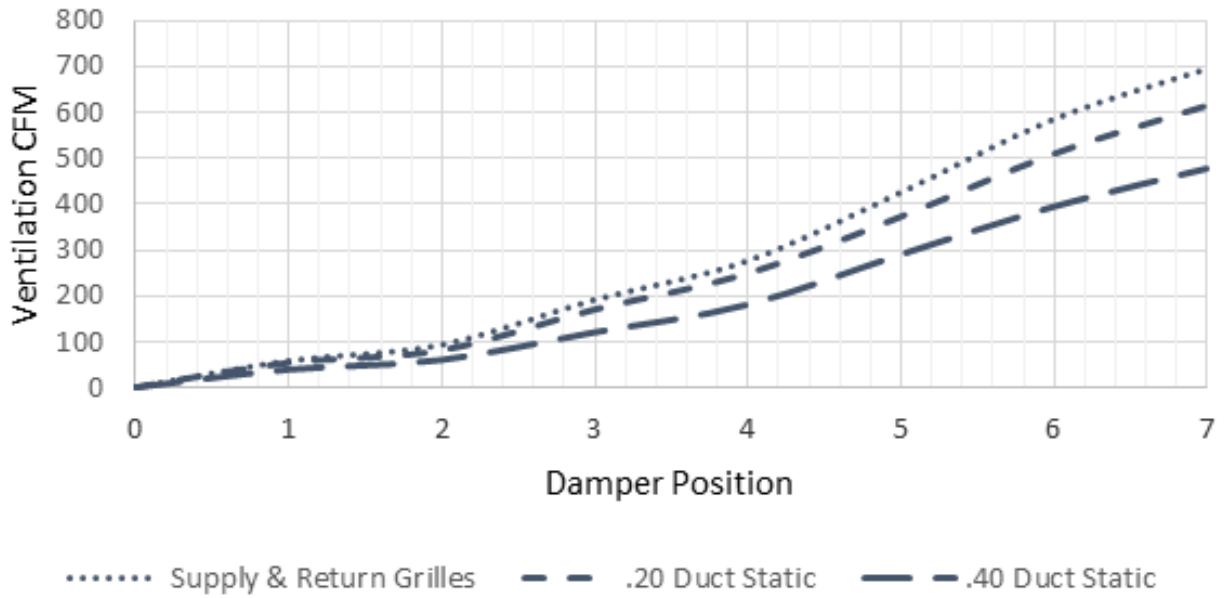

GRAPH 3
W48°C and W4SAC CRV-F5 Ventilation Delivery

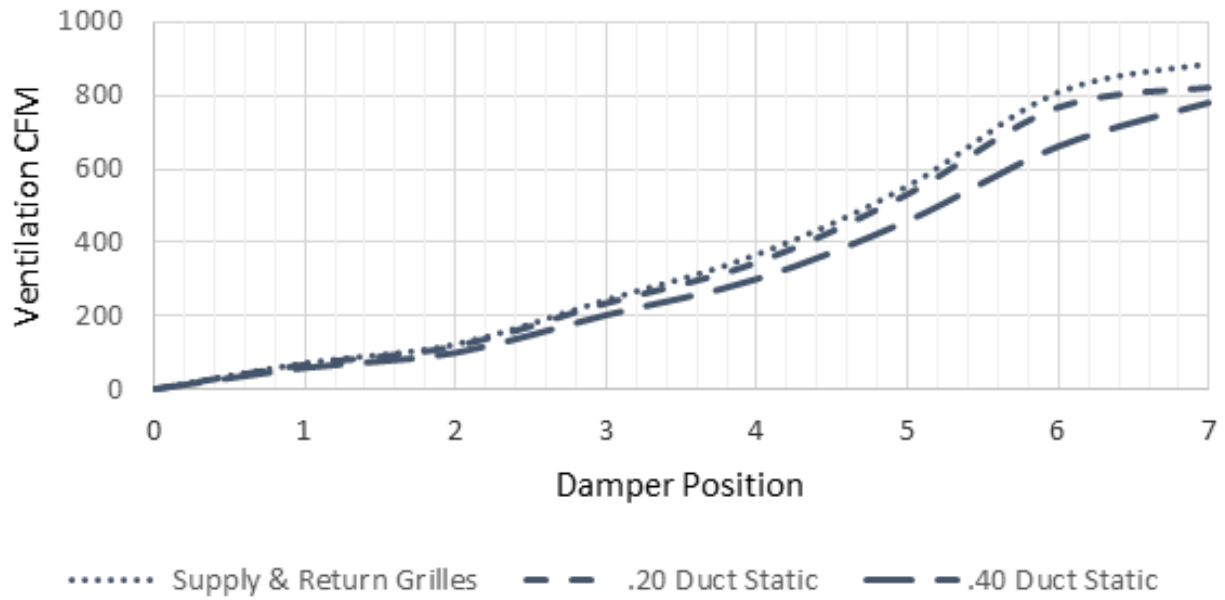

GRAPH 4
W60°C and W5SAC CRV-F5 Ventilation Delivery

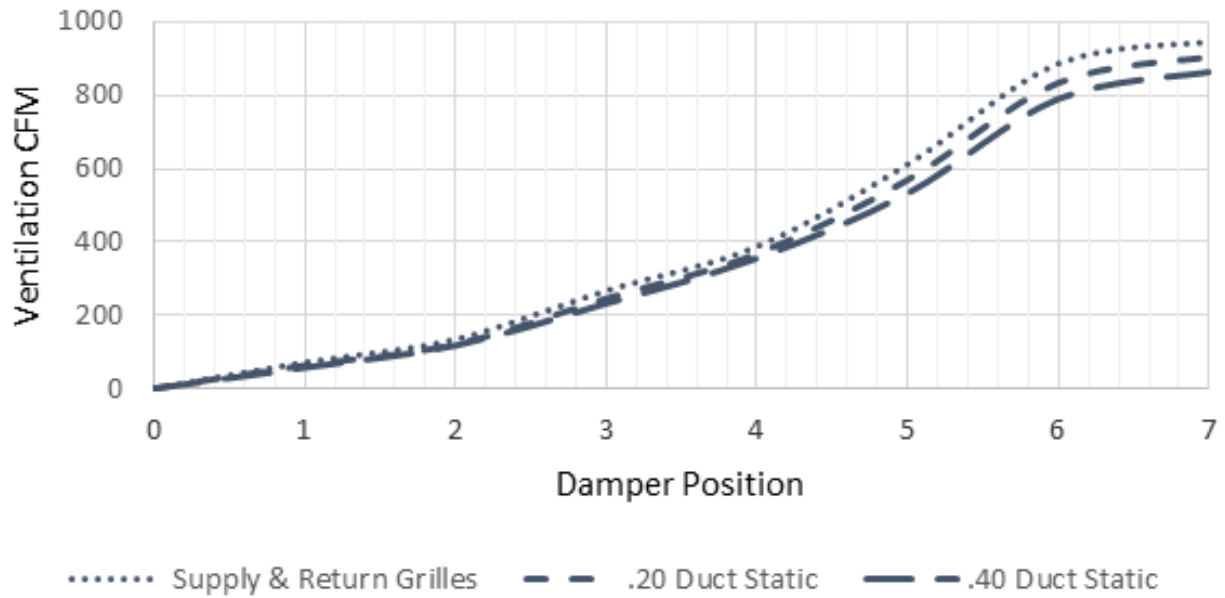

GRAPH 5
W72AC CRV-F5 Ventilation Delivery

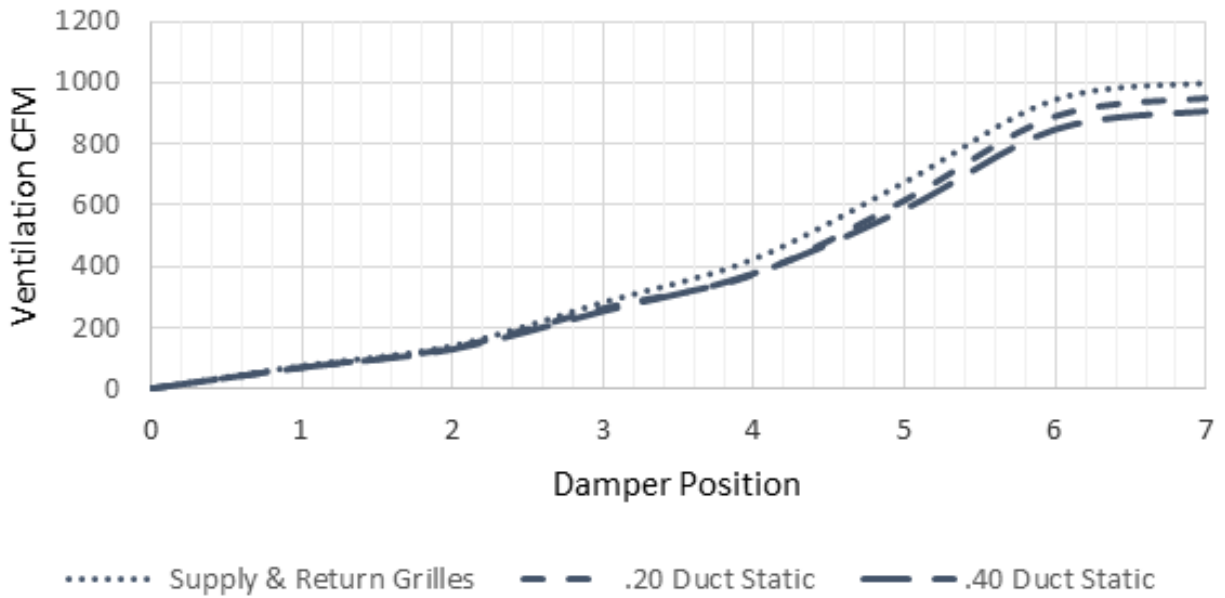

GRAPH 6
C36H AND C42H CRV-F5 Ventilation Delivery

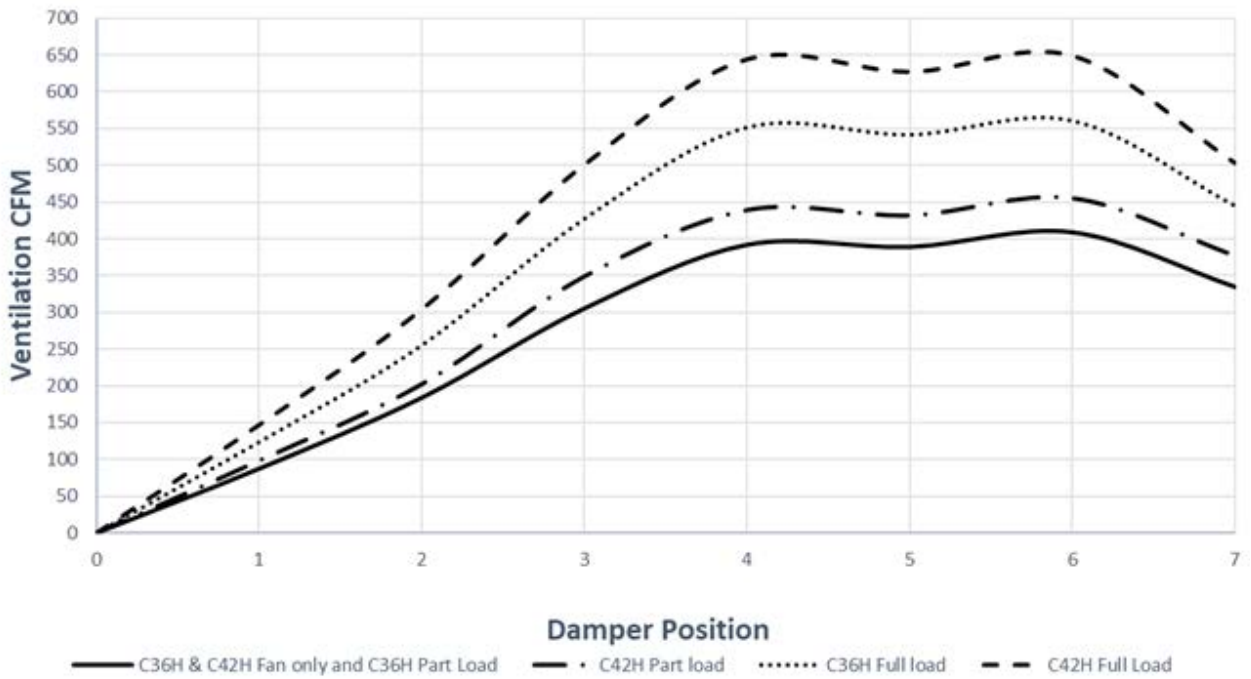

GRAPH 7
C48H AND C60H CRV-F5 Ventilation Delivery

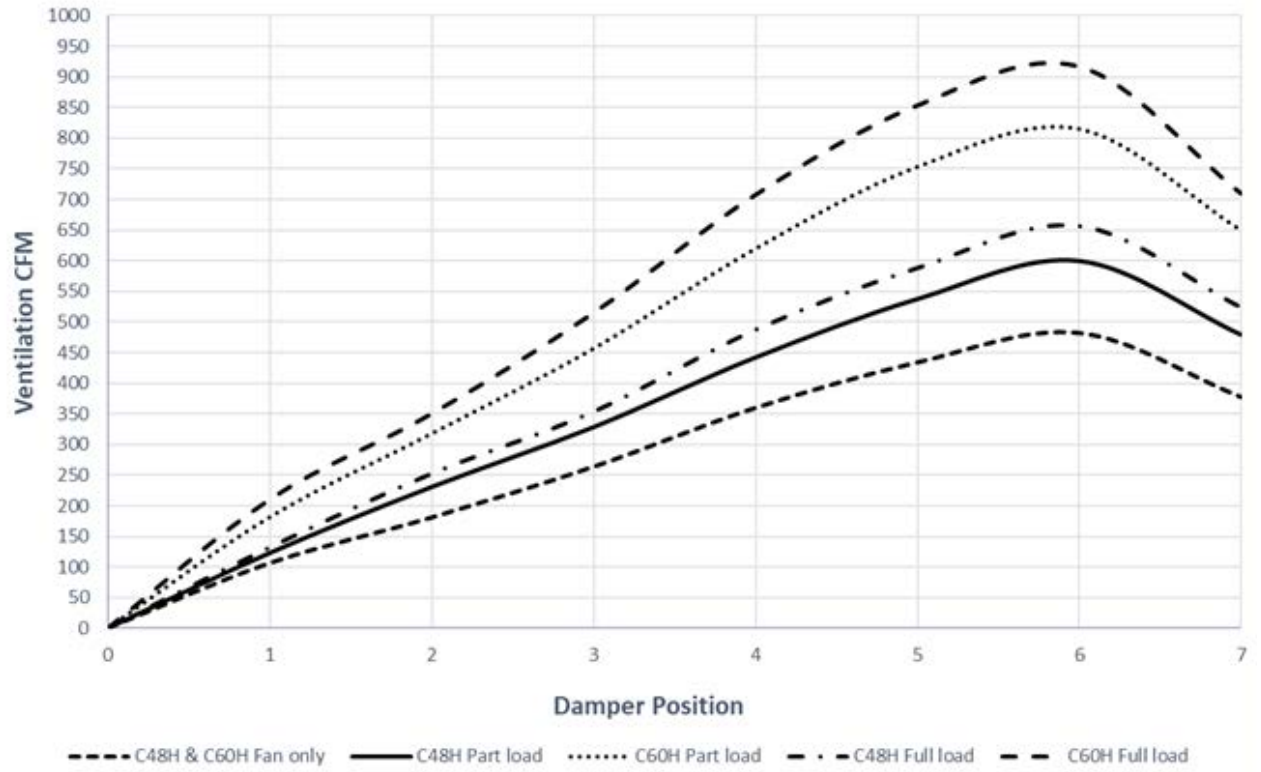
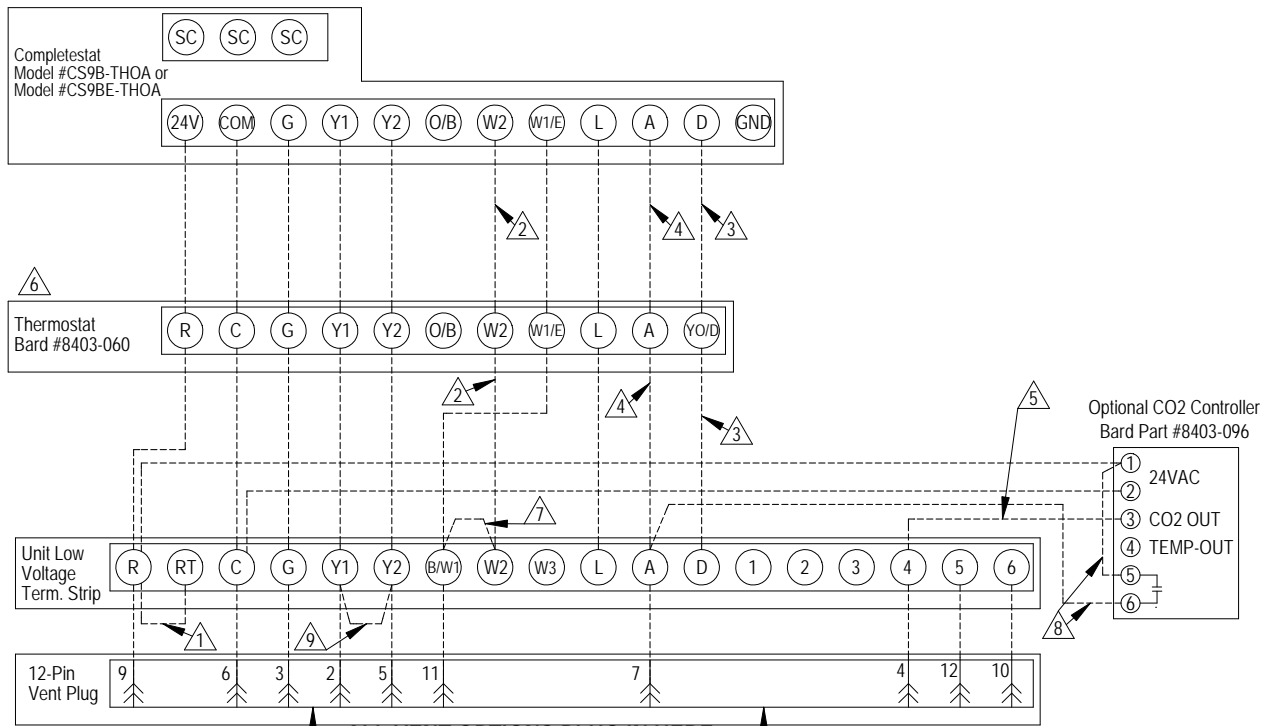

FIGURE 18
Programmable Thermostat Connections for CRV with Single Stage Air Conditioners



ALL VENT OPTIONS PLUG IN HERE
If not equipped with a ventilation option to plug in, a jumper plug must be installed.

- △1 Factory installed jumper. Remove jumper and connect to N.C fire alarm circuit if emergency shutdown required.
- △2 Wire not needed below 15KW.
- △3 Wire required for dehumidification models only.
- △4 Do not connect "A" from thermostat if optional CO2 controller is used
- △5 0-10 VDC modulating CO2 control signal for modulating ventilation control (optional for ECON only - see vent instruction manuals)

- △6 Change model configuration from heat pump to heat/cool. Must be configured to programmable and fan set to be programmed fan for the "A" output to function during scheduled occupied periods. Must be configured for multi-stage for Y1 output to be active 1st stage cooling. For dehumidification, must be configured for "No Economizer" for YO/D to be active for humidity control.
- △7 Install jumper for 1 stage electric heat on units with more than 10KW
- △8 Do not add these wires if setting up for modulating control. See note 5.
- △9 Factory installed jumper. Remove jumper to activate Balanced Climate™ mode. A 2-stage thermostat is recommended for Balanced Climate mode. Y1 Y2 jumper not present if economizer is factory installed. Units with economizers have balanced climate jumper in economizer, refer to economizer manual.

MIS-3974 D

FIGURE 19
Programmable Thermostat Connections for CRV with 2-Stage Air Conditioners

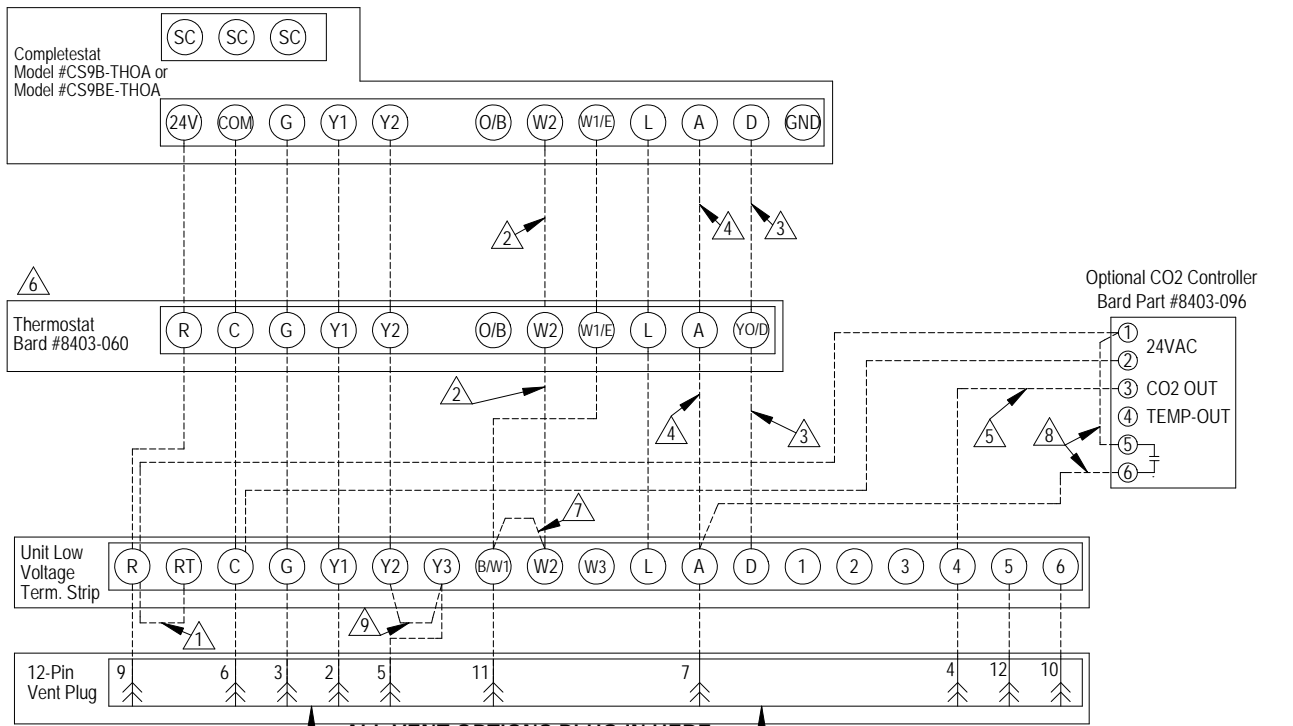

ALL VENT OPTIONS PLUG IN HERE
If not equipped with a ventilation option to plug in, a jumper plug must be installed.

- | | |
|---|--|
| <ul style="list-style-type: none"> ⚠ 1 Factory installed jumper. Remove jumper and connect to N.C fire alarm circuit if emergency shutdown required. ⚠ 2 Wire not needed below 15KW. ⚠ 3 Wire required for dehumidification models only. ⚠ 4 Do not connect "A" from thermostat if optional CO2 controller is used ⚠ 5 0-10 VDC modulating CO2 control signal for modulating ventilation control (optional for ECON only - see vent instruction manuals) | <ul style="list-style-type: none"> ⚠ 6 Change model configuration from heat pump to heat/cool. Must be configured to programmable and fan set to be programmed fan for the "A" output to function during scheduled occupied periods. Must be configured for multi-stage for Y1 output to be active 1st stage cooling. For dehumidification, must be configured for "No Economizer" for YO/D to be active for humidity control. ⚠ 7 Install jumper for 1 stage electric heat on units with more than 10KW ⚠ 8 Do not add these wires if setting up for modulating control. See note 5. ⚠ 9 Factory installed jumper. Remove jumper to activate Balanced Climate™ mode. A 3-stage thermostat is recommended for Balanced Climate mode. Must not be removed if Econ is installed. |
|---|--|

MIS-4067 C

FIGURE 20
Programmable Thermostat Connections for CRV with Heat Pumps

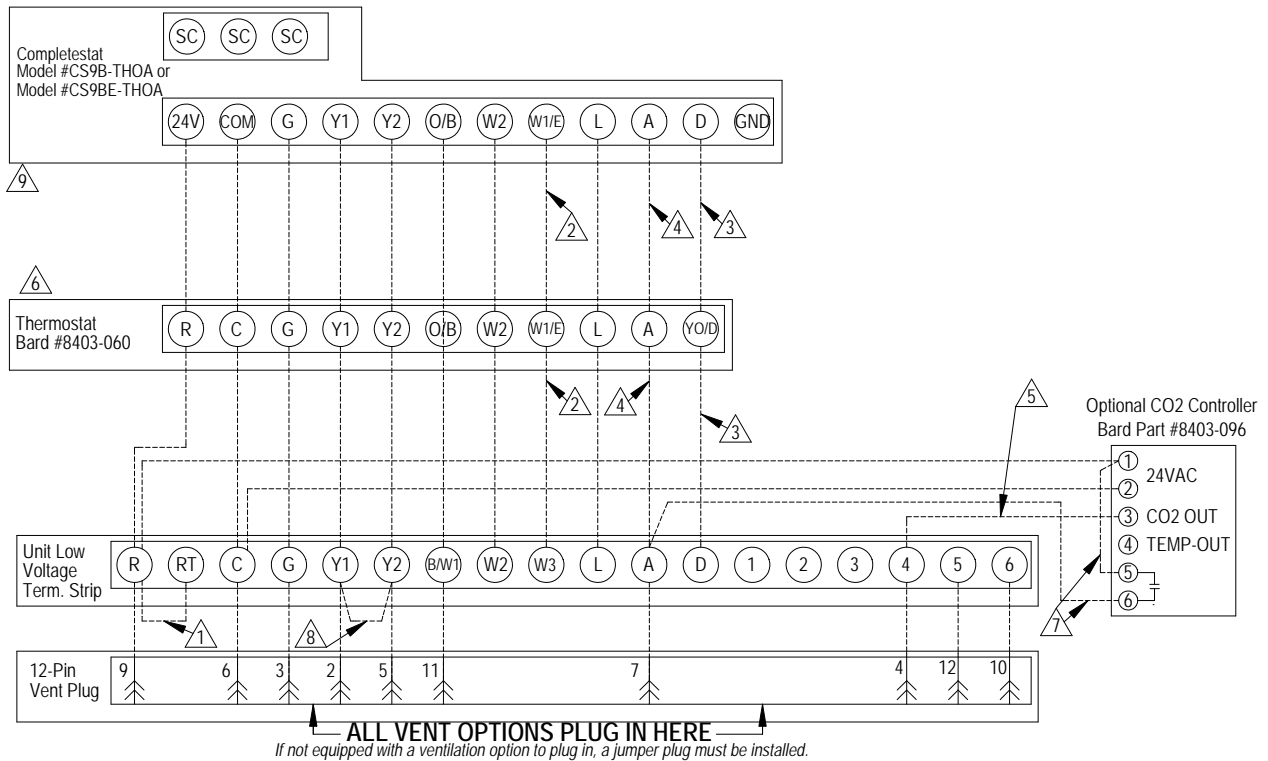

ALL VENT OPTIONS PLUG IN HERE
If not equipped with a ventilation option to plug in, a jumper plug must be installed.

- ① Factory installed jumper. Remove jumper and connect to N.C fire alarm circuit if emergency shutdown required.
- ② Wire not needed below 15KW.
- ③ Wire required for dehumidification models only.
- ④ Do not connect "A" from thermostat if optional CO2 controller is used
- ⑤ 0-10 VDC modulating CO2 control signal for modulating ventilation control (optional for ECON only - see vent instruction manuals)
- ⑥ Ensure model configuration is heat pump and not heat/cool. Must be configured to programmable and fan set to be programmed fan for the "A" output to function during scheduled occupied periods. Must be configured for multi-stage for Y1 output to be active 1st stage cooling. For dehumidification, must be configured for "No Economizer" for YO/D to be active for humidity control.
- ⑦ Do not add these wires if setting up for modulating control.
- ⑧ Factory installed jumper. Remove jumper to activate Balanced Climate TM Mode. A 2-stage thermostat is recommended for balanced climate mode. Y1 Y2 jumper not present if economizer is factory installed. Units with economizers have balanced climate jumper in economizer, refer to economizer manual. The jumper is factory removed in the unit and on jade for C**HY models.
- ⑨ Completestat not compatible with C**HY models.

MIS-4063 F

FIGURE 21
Non-Programmable Thermostat Connections for CRV with Single Stage Air Conditioners

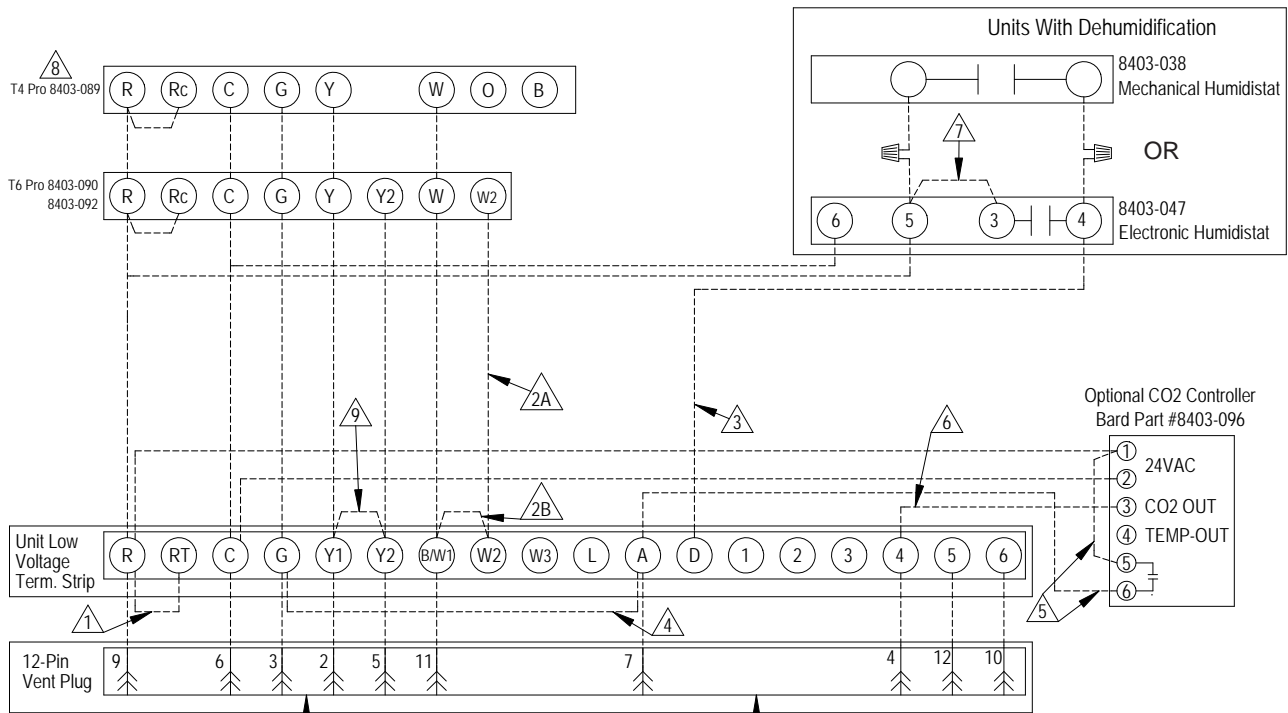

ALL VENT OPTIONS PLUG IN HERE

If not equipped with a ventilation option to plug in, a jumper plug must be installed.

- 1 Factory installed jumper. Remove jumper and connect to N.C fire alarm circuit if emergency shutdown required.
- 2A Wire not needed below 15KW.
- 2B Install Jumper for 1 stage electric heat on units with more than 10KW.
- 3 Wire required for dehumidification models only.
- 4 For vent operation, add jumper if optional CO2 controller is not used. Vent will run while blower is energized. For ECON & CRV-V an additional wire change is required See install Manual.
- 5 Do not add these wires if setting up for modulating control. See note 6.
- 6 0-10 VDC Modulating CO2 control signal for modulating ventilation control (Optional for ECON Only) - See vent installation manual.
- 7 Jumper needs added.
- 8 Thermostat will not work with units equipped with economizers.
- 9 Factory installed jumper. Remove jumper to activate Balanced Climate™ Mode. A 2-stage thermostat is recommended for Balanced Climate mode. Y1 Y2 jumper not present if economizer is factory installed. Units with economizers have balanced climate jumper in economizer, refer to economizer manual.

MIS-3975 E

FIGURE 22
Non-Programmable Thermostat Connections for CRV with 2-Stage Air Conditioners

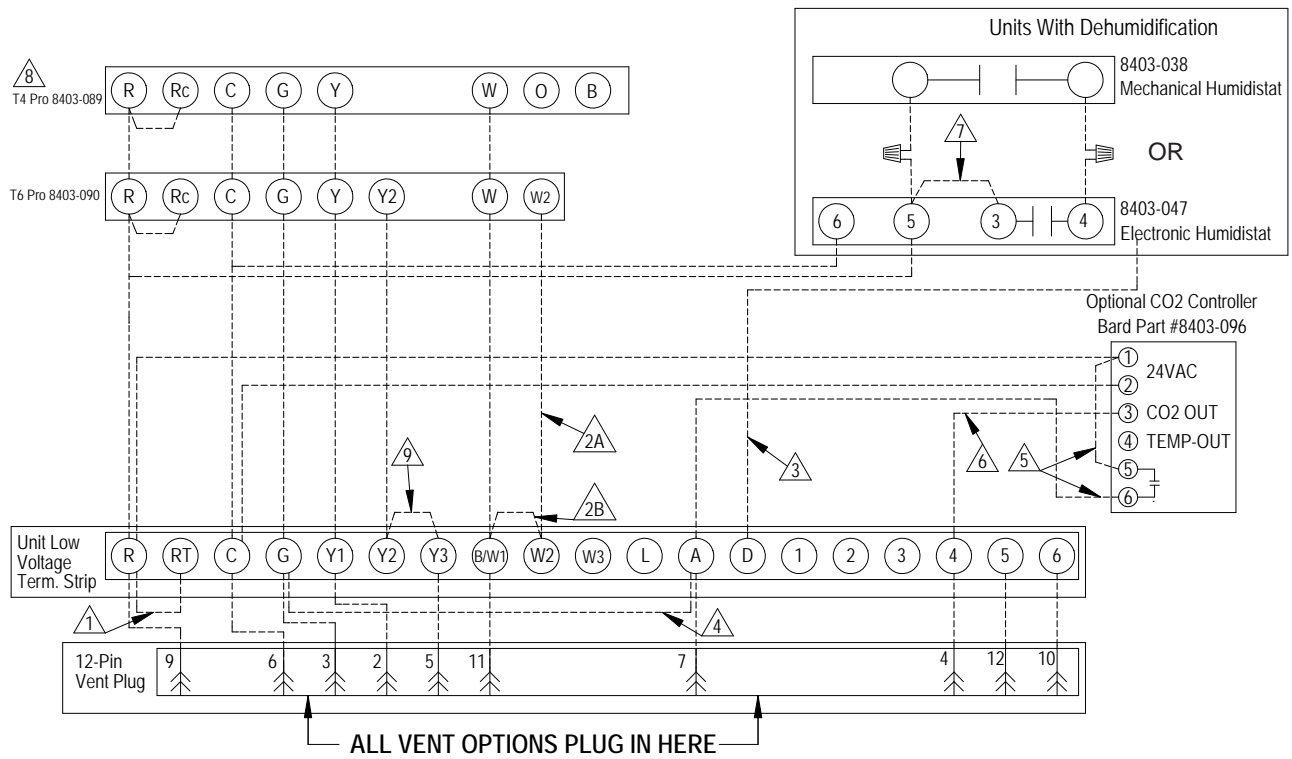

ALL VENT OPTIONS PLUG IN HERE

If not equipped with a ventilation option to plug in, a jumper plug must be installed.

- ⚠️ Factory installed jumper. Remove jumper and connect to N.C fire alarm circuit if emergency shutdown required.
- ⚠️ Wire not needed below 15KW.
- ⚠️ Install Jumper for 1 stage electric heat on units with more than 10KW.
- ⚠️ Wire required for dehumidification models only.
- ⚠️ For vent operation, add jumper if optional CO2 controller is not used.
- ⚠️ Vent will run while blower is energized.
- ⚠️ For ECON & CRV-V an additional wire change is required See install Manual.
- ⚠️ Do not add these wires if setting up for modulating control. See note 6.
- ⚠️ 0-10 VDC Modulating CO2 control signal for modulating ventilation control (Optional for ECON Only) - See vent installation manual.
- ⚠️ Jumper needs added.
- ⚠️ Thermostat will not work with units equipped with economizers.
- ⚠️ Factory installed jumper. Remove jumper to activate Balanced Climate™ Mode. A 3-stage thermostat is recommended for Balanced Climate mode. Must not be removed if Econ is installed.

MIS-4068 C

FIGURE 23
Non-Programmable Thermostat Connections for CRV with Heat Pumps

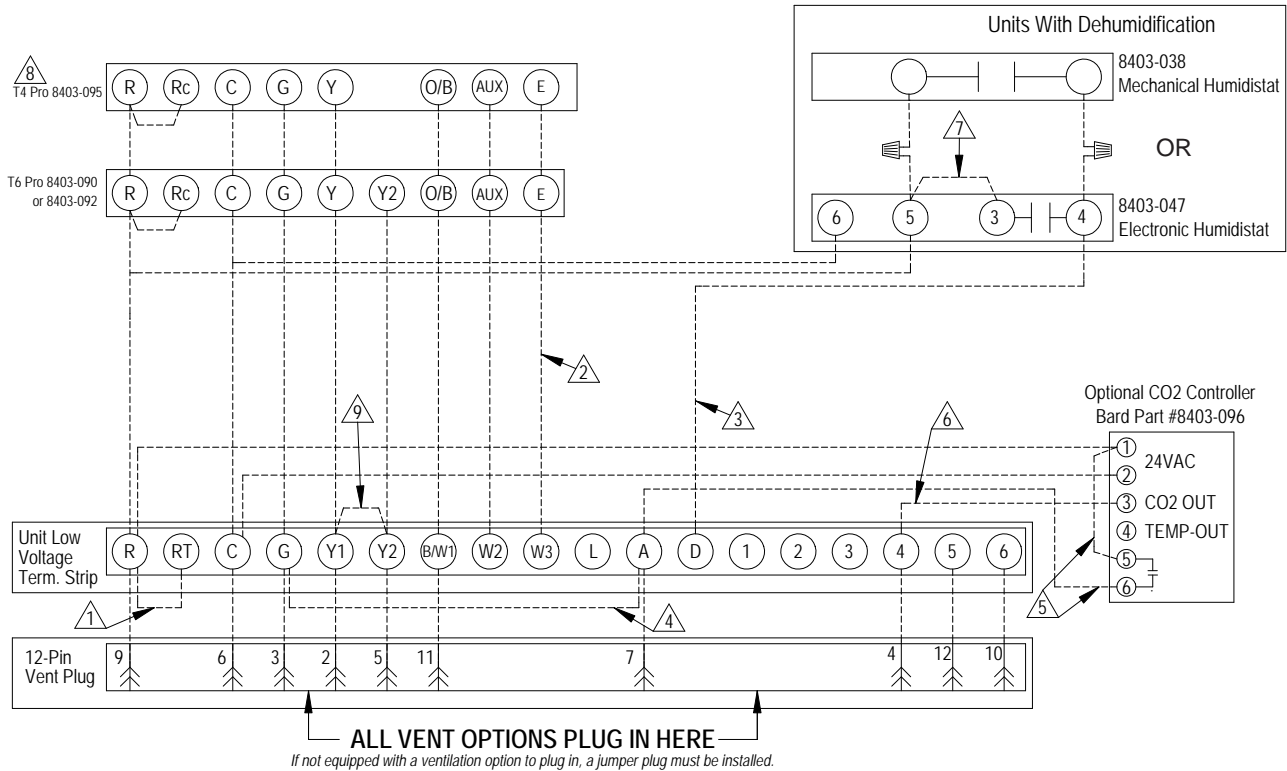

If not equipped with a ventilation option to plug in, a jumper plug must be installed.

- | | |
|---|---|
| <p>1 Factory installed jumper. Remove jumper and connect to N.C fire alarm circuit if emergency shutdown required.</p> <p>2 Wire not needed below 15KW.</p> <p>3 Wire required for dehumidification models only.</p> <p>4 For vent operation, add jumper if optional CO2 controller is not used. Vent will run while blower is energized. For ECON & CRV-V, an additional wire change is required. See install manual</p> <p>5 Do not add these wires if setting up for modulating control. See note 6.</p> | <p>6 0-10 VDC Modulating CO2 control signal for modulating ventilation control (Optional for ECON Only) - See vent installation manual.</p> <p>7 Jumper needs added.</p> <p>8 Thermostat will not work with units equipped with economizers. T4 pro not compatible with C**HY models</p> <p>9 Factory installed jumper. Remove jumper to activate Balanced Climate™ Mode. A 2-stage thermostat is recommended for Balanced Climate mode. Y1 Y2 jumper not present if economizer is factory installed. Units with economizers have balanced climate jumper in economizer, refer to economizer manual. The jumper is factory removed in the unit and on jade for C**HY models</p> |
|---|---|

MIS-4064 G

FIGURE 24
CRV-F* Wiring Diagram

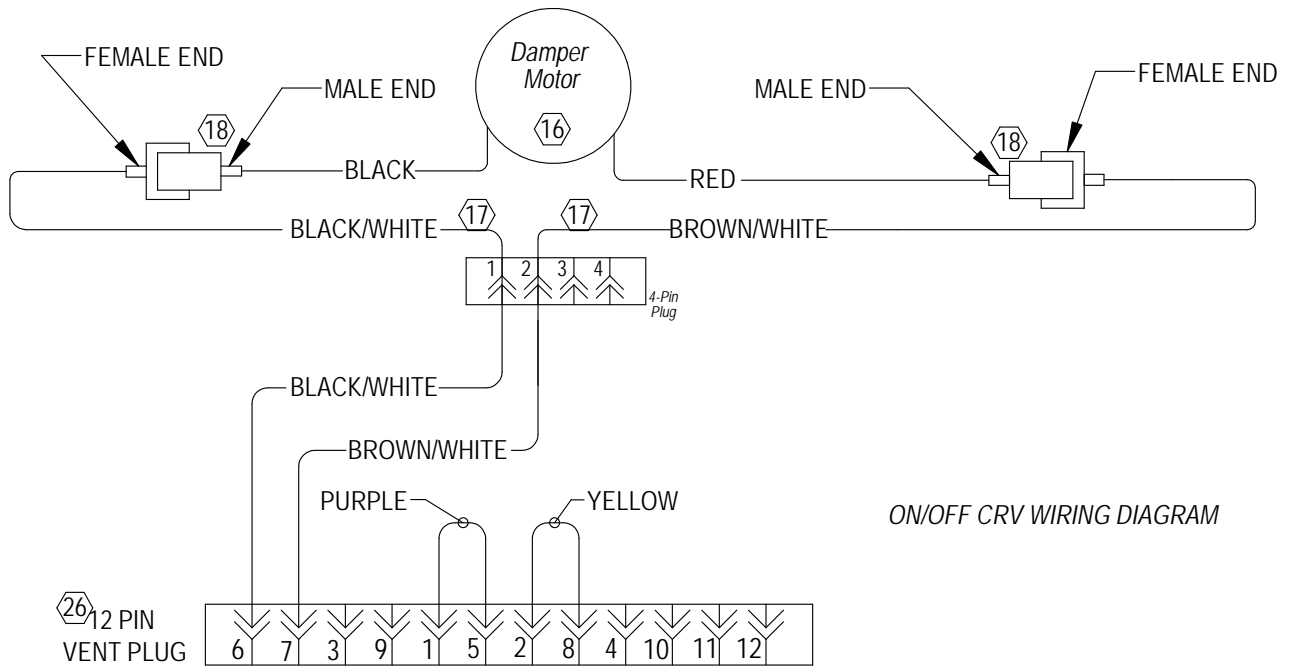

4056-244

Sequence of Operation

On/Off ventilation options energize when the “A” low voltage strip terminal is energized signaling occupancy, and de-energize when “A” terminal is no longer receiving a 24VAC signal. The “G” low voltage strip terminal is used to operate the indoor blower for unit airflow.

The M On/Off CRV vent option is a damper blade operated by a 24VAC motor that when energized opens to a pre-adjusted setting. The airflow amount being brought in will be dependent on the blower speed during unit operation.

TABLE 1
WAC and W**HC Unit Operation with M Ventilation Option**

Unit Operation	Occ. Signal	Low Voltage 24VAC							Speed Taps			Fan Speed	Comp. Oper.	Damper
		G	Y1	Y2	W1	W2	A	D	1	2	3-4-5 ¹			
Fan Only	Yes	X					X		X			Vent	Off	Open
Fan Only	No	X							X			Vent	Off	Closed
BC Cooling	Yes		X				X		X	X		B Climate	On	Open
BC Cooling	No		X						X	X		B Climate	On	Closed
Full Load Cool	Yes		X	X			X		X	X	X	Lo/Med/Hi	On	Open
Full Load Cool	No		X	X					X	X	X	Lo/Med/Hi	On	Closed
1st Stage Heat	Yes				X		X				X	Lo/Med/Hi	Off	Open
1st Stage Heat	No				X						X	Lo/Med/Hi	Off	Closed
2nd Stage Heat	Yes				X	X	X				X	Lo/Med/Hi	Off	Open
2nd Stage Heat	No				X	X					X	Lo/Med/Hi	Off	Closed
Dehumidify ²	Yes						X	X	X	X		B Climate	On	Open
Dehumidify ²	No							X	X	X		B Climate	On	Closed

BC and B Climate – Balanced Climate

- ¹ Fan speed is selectable through the blower speed control terminal block. LO (default), MED or HI speeds can be used.
- ² Dehumidification operation is disabled when a call for heating or cooling occurs. Unit runs at Balanced Climate speed during dehumidification operation.

TABLE 2
W*SAC Unit Operation with M Ventilation Option

Unit Operation	Occ. Signal	Low Voltage 24VAC								Speed Taps			Fan Speed	Comp. Oper.	Damper
		G	Y1	Y2	Y3	W1	W2	A	D	1	2	3-4-5 ¹			
Blower Only	Yes	X						X		X			Vent	Off	Open
Blower Only	No	X								X			Vent	Off	Closed
Part Load Cool	Yes	X	X					X		X	X		B Climate	On	Open
Part Load Cool	No	X	X							X	X		B Climate	On	Closed
BC Cooling	Yes	X	X	X				X		X	X		B Climate	On	Open
BC Cooling	No	X	X	X						X	X		B Climate	On	Closed
Full Load Cool	Yes	X	X	X	X			X		X	X	X	Lo/Med/Hi	On	Open
Full Load Cool	No	X	X	X	X					X	X	X	Lo/Med/Hi	On	Closed
1st Stage Heat	Yes					X		X				X	Lo/Med/Hi	Off	Open
1st Stage Heat	No					X						X	Lo/Med/Hi	Off	Closed
2nd Stage Heat	Yes					X	X	X				X	Lo/Med/Hi	Off	Open
2nd Stage Heat	No					X	X					X	Lo/Med/Hi	Off	Closed
Dehumidify ²	Yes							X	X	X	X		B Climate	On	Open
Dehumidify ²	No								X	X	X		B Climate	On	Closed

BC and B Climate – Balanced Climate

- ¹ Fan speed is selectable through the blower speed control terminal block. LO (default), MED or HI speeds can be used.
² Dehumidification operation is disabled when a call for heating or cooling occurs. Unit runs at Balanced Climate speed during dehumidification operation.

TABLE 3
CHY Unit Operation with M Ventilation Option**

Unit Operation	Occ. Signal	Low Voltage 24VAC							Compressor	Fan Speed	Damper Potentiometer
		G	Y1	Y2	W1	W2	W3	A			
Blower Only	Yes	X						X	Off	Vent	Open
Blower Only	No	X							Off	Vent	Closed
Part Load Cool	Yes		X					X	On	Part Load	Open
Part Load Cool	No		X						On	Part Load	Closed
Full Load Cool	Yes		X	X				X	On	Full Load	Open
Full Load Cool	No		X	X					On	Full Load	Closed
1st Stage Heat	Yes		X		X			X	Off	Part Load	Open
1st Stage Heat	No		X		X				Off	Part Load	Closed
2nd Stage Heat	Yes		X	X	X			X	Off	Full Load	Open
2nd Stage Heat	No		X	X	X				Off	Full Load	Closed
2nd Stage Heat and Emergency Heat	Yes		X	X	X	X		X	On	Full Load	Open
2nd Stage Heat and Emergency Heat	No		X	X	X	X			On	Full Load	Closed
Emergency Heat	Yes					X	X	X	Off	Full Load	Open
Emergency Heat	No					X	X		Off	Full Load	Closed

FIGURE 25
Call for Ventilation With or Without Compressor Operation

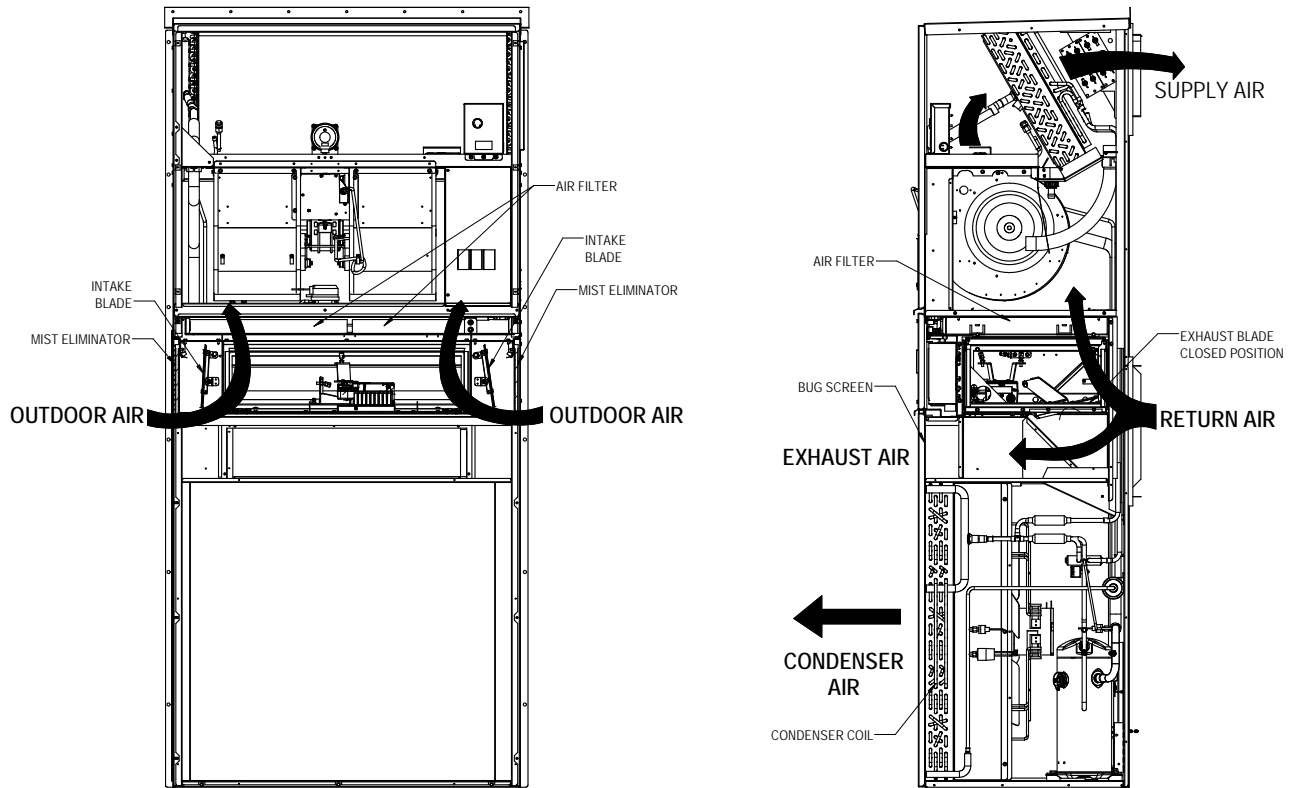

MIS-4038

FIGURE 26
Call for Compressor or Fan Only with Ventilation Off

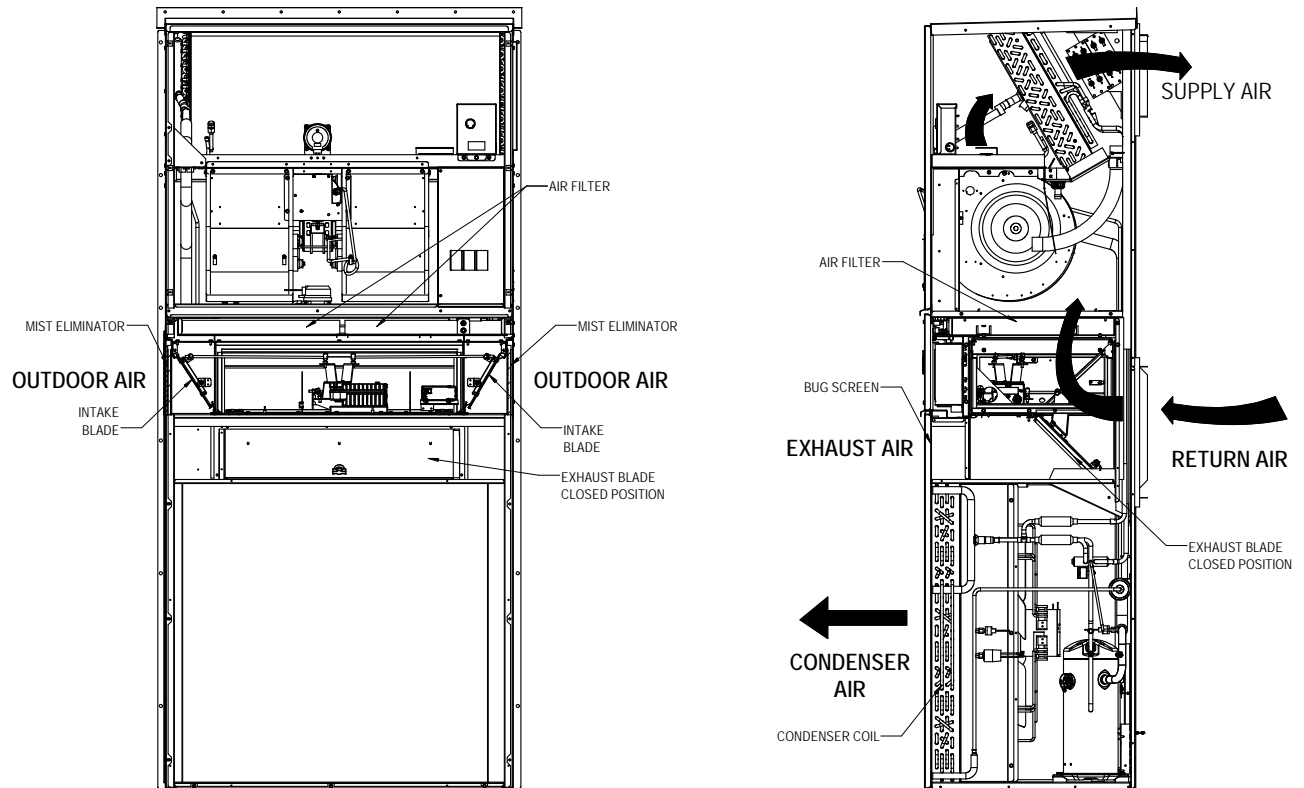

MIS-4037