INSTALLATION INSTRUCTIONS

Full Flow Modulating Low Leakage Economizer with Exhaust for Building Applications

Models: ECON-DB5A/ECON-WD5A



For Use with Bard Wall Mount
Air Conditioner and Heat Pump Models:

W/J3SAC, W/J4SAC, W/J5SAC
W/J42AC, W/J48AC, W/J60AC, W/J72AC
W/J42HC, W/J48HC, W/J60HC

NOTE: *These instructions are written to cover field-installed economizers, but are also included with factory-installed economizers. For factory-installed economizers, all portions addressing “installation” are for reference only.*

BMC, Inc.
Bryan, Ohio 43506

Manual: 2100-753C
Supersedes: 2100-753B
Date: 7-6-22

CONTENTS

General Information	3
Economizer Model Nomenclature	3
General Economizer Information	3
JADE™ Controller Technical Specifications.....	4
Environmental Information	4
Electrical Information	4
Sensors	4
Unpacking (Field Installation Only)	4
Kit Components (Field Installation Only).....	4
Service	4

Installation of Field-Installed ECON-DB5A/ ECON-WD5A	5
Basic Installation.....	5
Blade Adjustment for Desired Ventilation Air	11

Start-Up/Checkout Procedures	12
JADE Economizer Controller	12
Economizer Quick Start.....	12
Quick Start Basic JADE Economizer Control Setup (SETPOINTS Menu)	12
Outdoor Temperature or Humidity Adjustment Procedure.....	12
Minimum Position Setting.....	13
Low Outdoor Temperature Compressor Lockout.....	13
Mixed Air Temperature Setting.....	13
Quick Start Economizer Operational Checkout (CHECKOUT Menu)	13
Checkout Procedure.....	13
JADE Economizer Control Advanced Setup.....	14
Review/Customize System Setup.....	14
Enthalpy Settings	18
Economizer Sequence of Operation	24
Economizer Operation for Single Stage	26
Balanced Climate Mode – S, Y and Z Option Economizer Sequence of Operation	27
Single Stage Compressor Units – Economizer Operation – Balanced Climate Mode.....	29
2-Stage Compressor Units – Economizer Operation – Part and Full Load Operation Balanced Climate Unavailable	30

TABLES

Table 1	System Setup Menu Levels	14
Table 2	Advanced Setup Menu Levels.....	15
Table 3	Setpoints Menu Levels.....	15
Table 4	Checkout Menu Levels.....	16
Table 5	Status Menu Levels.....	16
Table 6	Alarm Examples	17
Table 7	Unit Operation with S (Part Flow), Y and Z (Full Flow) Economizer Options Single Stage AC Units	27
Table 8	Unit Operation with S (Part Flow), Y and Z (Full Flow) Economizer Options 2-Stage Compressor Units.....	28

FIGURES

Figure 1	Disconnect Power	5
Figure 2	Remove Side Grilles	5
Figure 3	Remove Blower Door, Control Panel and Condenser Grille	5
Figure 4	Remove Blank Off Plates (Both Sides)....	6
Figure 5	Remove Exhaust Blank Off Plate	6
Figure 6	Remove Air Filters and Low Voltage Control Panel Cover	6
Figure 7	Install 910-2063 Control Board Assembly (Single Stage Units).....	6
Figure 8	Install 910-2063 Control Board Assembly (W*SAC 2-Stage Units)	7
Figure 9	W*SAC 2-Stage Unit Wire Connection....	7
Figure 10	Install Economizer	7
Figure 11	Control Plug Centered in Plug Access Opening	7
Figure 12	Connect Economizer Power Plug to Control Panel Plug	8
Figure 13	Install Indoor Mixed Air Sensor Assembly	8
Figure 14	Route Orange Mixed Air Sensor Wires....	8
Figure 15	Secure Sensor Wires with Ladder Ties	8
Figure 16	Connect Mixed Air Sensor Plug.....	9
Figure 17	Enthalpy Sensor Assembly Installation ...	9
Figure 18	Temperature Only Sensor Assembly Installation	9
Figure 19	Route Wires and Secure with Ties	9
Figure 20	Route Cable Through Control Panel Bushing	9
Figure 21	Route Cable and Connect to Red and Black Wires	10
Figure 22	Wiring Connections Completed	10
Figure 23	Release the Exhaust Blade.....	10
Figure 24	Exhaust Blade and Latch	10
Figure 25	Install Intake Sealing Frame and Lower Block Off Plates	11
Figure 26	Install Mist Filters.....	11
Figure 27	Install Bug Screen and Gaskets	11
Figure 28	JADE Economizer Controller	12
Figure 29	Programmable Thermostat Connections for ECON-**5 with Single Stage Air Conditioners	19
Figure 30	Programmable Thermostat Connections for ECON-**5 with 2-Stage Air Conditioners	20
Figure 31	Programmable Thermostat Connections for ECON-**5 with Heat Pumps.....	21
Figure 32	Non-Programmable Thermostat Connections for ECON-**5 with Air Conditioners	22
Figure 33	Non-Programmable Thermostat Connections for ECON-**5 with Heat Pumps	23
Figure 34	100% Airflow	24

Figure 35 Mixed Airflow Path 24
 Figure 36 Call for Compressor or Fan Only with Ventilation Off 25
 Figure 37 CO₂ Sensor Default and Final Settings Bard Part #8403-096 CO₂ Controller... 31
 Figure 38 Wiring Diagram – Enthalpy Sensor 35
 Figure 39 Wiring Diagram – Temperature Only Sensor 36
 Figure 40 Lubrication Points..... 37

GRAPHS

Graph 1 W3SAC ECON-E & WD Ventilation Delivery..... 32
 Graph 2 W/J42°C ECON-E & WD Ventilation Delivery..... 32
 Graph 3 W4SAC & W/J48°C ECON-E & WD Ventilation Delivery 33
 Graph 4 W5SAC and W/J60°C ECON-E & WD Ventilation Delivery 33
 Graph 5 W/J72AC ECON-E & WD Ventilation Delivery..... 34

GENERAL INFORMATION

Economizer with Exhaust Model Nomenclature

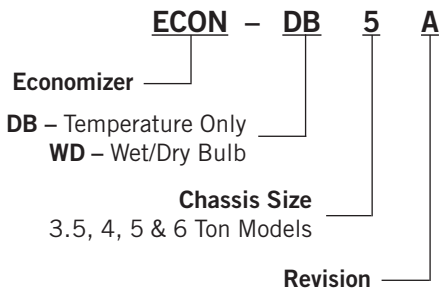

General Economizer Information

Using an economizer provides economical cooling without the need for running the compressor and refrigeration system when outdoor conditions are acceptable to bring air into the building. By bringing in outdoor air to cool a building, energy use is reduced to the power required to operate the indoor fan and the economizer controls. Energy use is a fraction of the power required to operate the refrigeration system. The following benefits can be attributed to the economizer:

- Reduced energy costs when outdoor conditions are acceptable to bring air into the building.
- Lengthen the life expectancy of the refrigeration components due to lower operating time.
- Provide a source of air for an occupied area to meet building code requirements.
- Reduce stress to refrigeration equipment during extremely cold outdoor temperatures by using outdoor air to cool.

Economizer usage is beneficial for several applications including equipment cooling and keeping occupants comfortable while keeping energy costs at a minimum.

There are two distinct types of economizers that will be discussed in this manual:

- **ECON-DB models:** The ECON-DB economizer allows outdoor air to enter the building when the

outdoor temperature monitored by an outdoor sensor is below the user-selectable outdoor temperature setpoint in the JADE controller. Economizer cooling operation is based on outdoor temperature only.

- **ECON-WD models:** The ECON-WD economizer allows outdoor air to enter the building when the outdoor temperature and humidity monitored by an outdoor sensor is below the user-selectable enthalpy curve in the JADE controller. Economizer cooling operation is based on outdoor temperature and humidity.

Typical equipment cooling applications will use either ECON-DB or ECON-WD models based on the sensitivity of equipment to indoor humidity levels. Cooling with occupants in a building often requires ECON-WD models to keep indoor conditions at a comfortable humidity level.

The economizer system consists of the following key features and components:

- Openings in the sides of the unit that allow outdoor air to enter the wall mount unit. A coarse filter covers the opening to reduce debris and moisture entry into the unit. Once the air enters the unit, it is drawn through the filter located above the vent area and transferred into the building by the indoor blower.
- An opening in the front of the unit that allows pressurized indoor air to leave the building. A corrosion-resistant screen covers the opening.
- Three blades located inside the economizer assembly that control the amount of air entering and leaving the building.
- A fully modulating spring return damper motor with a control arm, connecting rods and blade linkages that operate the economizer blades.
- The JADE solid-state controller that decides when conditions are acceptable for economizer operation. The controller has an easy to use menu

system that allows for troubleshooting and setup functionality. Diagnostics are also provided.

- A mixed air/supply sensor that is located above the indoor blower assembly.
- An outdoor sensor located in the lower left corner of the outdoor condenser area.

Overall, this manual is designed to explain how to field install the economizer, how the economizer functions and discuss economizer setup procedures. If this manual is being supplied with a wall mount unit that already has a factory-installed economizer, it may not be necessary to review the field installation portion of this manual.

JADE Controller Technical Specifications

The economizer system ships with standard settings pre-programmed from the factory. Normal use and operation may not require adjustments to the JADE settings. Advanced applications, however, may require additional setup and feature selection. The JADE model W7220 is used widely in the field, and heavily supported by the manufacturer. It is important to note that Bard does custom program the JADE for specific economizer models. If replacing the JADE is necessary, always order the JADE controller based on the Bard part number.

Environmental Information

Operating Temperature: -40 to 150°F (-40 to 65°C).
Exception of display operation down to -4°F with full recovery at -4°F from exposure to -40°F.

Storage Temperature: -40 to 150°F (-40 to 65°C)

Shipping Temperature: -40 to 150°F (-40 to 65°C)

Relative Humidity: 5% to 95% RH non-condensing

Electrical Information

Rated Voltage: 20 to 30 VAC RMS; 50/60 Hz
Nominal Power Consumption (at 24 VAC, 60 Hz): 11.5 VA without sensors and actuator

Relay Contact Rating at 30 VAC (maximum power from Class 2 input only): 1.5A run; 3.5A inrush @ 0.45PF (200,000 cycles) or 7.5A inrush @ 0.45PF (100,000 cycles)

External Sensors Power Output: 21 VDC +/- 5% @ 48mA

Sensors

Dry Bulb Sensor Temperature Range: -40 to 150°F (-40 to 65°C)

Temperature and Humidity Sensor Range: Temperature -40 to 150°F (-40 to 65°C), humidity 0 to 100% RH with 5% accuracy.

Optional CO₂ Sensor Input: 2-10 VDC control signal; minimum impedance >50k ohm.

Unpacking (Field Installation Only)

Upon receipt of the equipment be sure to compare the model number found on the shipping label with the accessory identification information on the ordering and shipping document to verify that the correct accessory has been shipped.

Inspect the carton housing of each ventilator as it is received, and before signing the freight bill, verify that all items have been received and that there is no visible damage (check parts list below). Note any shortages or damage on all copies of the freight bill. The receiving party must contact the last carrier immediately, preferably in writing, requesting inspection by the carrier's agent. Concealed damage not discovered until after loading must be reported to the carrier within 15 days of its receipt.

Kit Components (Field Installation Only)

The economizer should only be installed by a trained heating and air conditioning technician. These instructions serve as a guide to the technician installing the ventilator package. They are not intended as a step-by-step procedure with which the mechanically inclined owner can install the package.

The economizer housing is shipped in one carton which contains the electrical harness, miscellaneous hardware and installation instructions.

Economizer kit includes:

- ECON-WD5 full flow economizer
- 910-1980 sensor assembly (ECON-WD5)
- 910-1898E sensor assembly (ECON-DB5)
- 910-2063 economizer control board assembly
- 7003-084 mist filter (2)
- 7003-083 exhaust bug screen
- 1913-002-0808 8-1/2" foam strip (2)
- 1913-002-0708 7-1/2" foam strip (4)
- 539-405 intake sealing frame (2)
- 543-223 lower block off plate (2)
- 7950-12 push mount cable tie
- 7950-004 cable tie (8)
- #10-16x1/2 screw (12)
- #8-18x3/8 pan head screw (4)
- 2100-753 installation instructions

Service

The low leakage ventilators/economizers use stainless steel intake blade seals. It is recommended that the side seals, ball joints, and blade hinges be lubricated with a graphite dry lubricant once a year or during filter changes (see Figure 40 on page 37).

INSTALLATION OF FIELD-INSTALLED ECON-WD5/ECON-DB5

Basic Installation

⚠ WARNING

Electrical shock hazard.
Disconnect remote electrical power supply or supplies before servicing.
Failure to do so could result in electric shock or death.

⚠ WARNING

Exposed moving parts.
Disconnect electrical power before servicing.
Failure to do so could result in severe injury or amputation.

⚠ CAUTION

Cut hazard.
Wear gloves to avoid contact with sharp edges.
Failure to do so could result in personal injury.

Disconnect all power to unit (see Figure 1).

FIGURE 1
Disconnect Power



Remove both side grilles (see Figure 2).

FIGURE 2
Remove Side Grilles

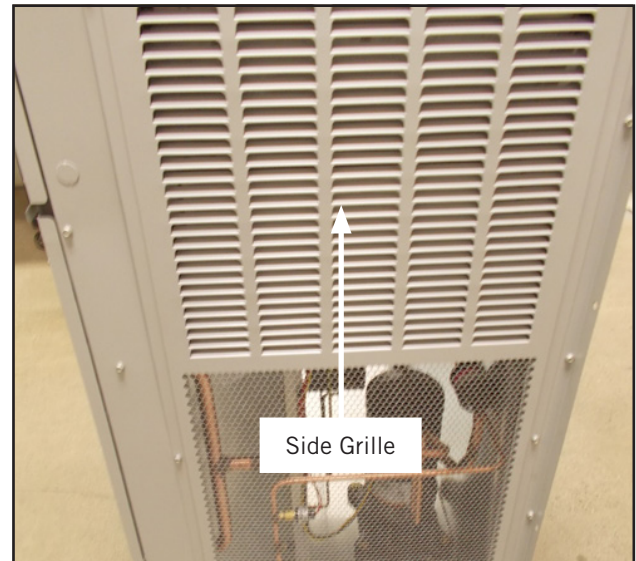

Remove upper blower door, outer control panel cover and front (lower) condenser grille (see Figure 3).

FIGURE 3
Remove Blower Door, Outer Control Panel Cover and Condenser Grille

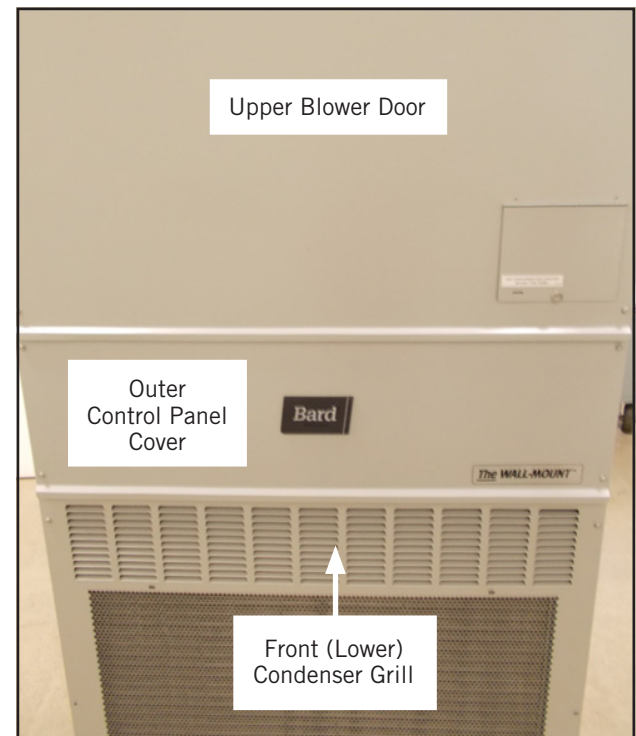

Remove blank off plates (both sides) and discard (see Figure 4). Retain screws for use with new vent.

FIGURE 4
Remove Blank Off Plates (Both Sides)



Remove exhaust blank off plate through return or through side intake openings and discard (see Figure 5).

FIGURE 5
Remove Exhaust Blank Off Plate

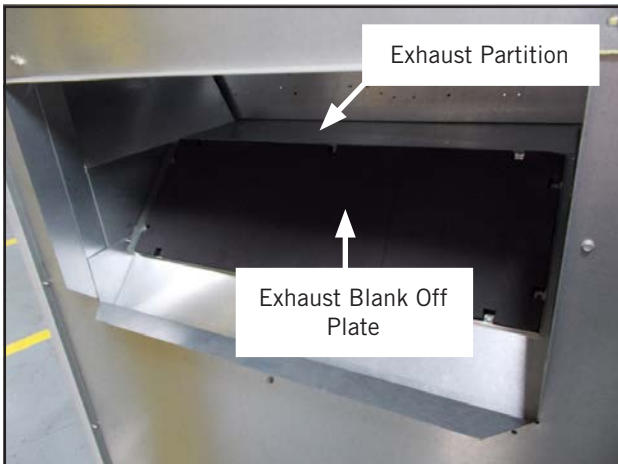

Remove both air filters and the low voltage inner control panel cover (see Figure 6).

FIGURE 6
Remove Air Filters and Low Voltage Control Panel Cover

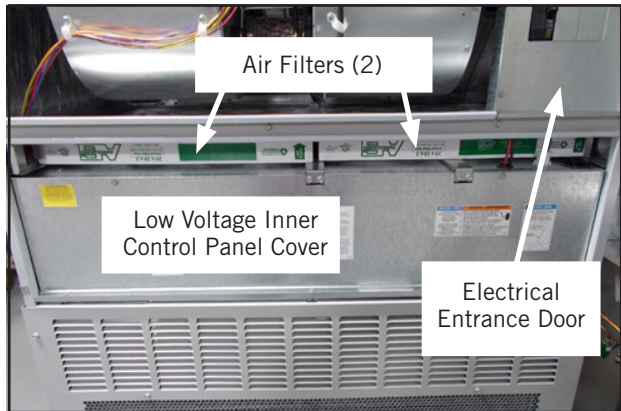

Install the 910-2063 control board assembly on the left side of the control panel using four (4) #10 x 1/2 screws (provided) as shown in Figure 7 (single stage units) and Figure 8 (2-stage units).

Snap the four wire connector into the opening next to the low voltage box. Plug the 12 pin male connector into the female plug in the low voltage box.

Remove wire channel cover and route four pin connector mixed air sensor and outdoor sensor wires inside channel; mixed air sensor and outdoor sensor wires will be connected later.

Remove the Y1-Y2 jumper from the low voltage terminal strip in order for the vent to function. This jumper is already removed in units with factory-installed economizers.

FIGURE 7
Install 910-2063 Control Board Assembly (Single Stage Units)

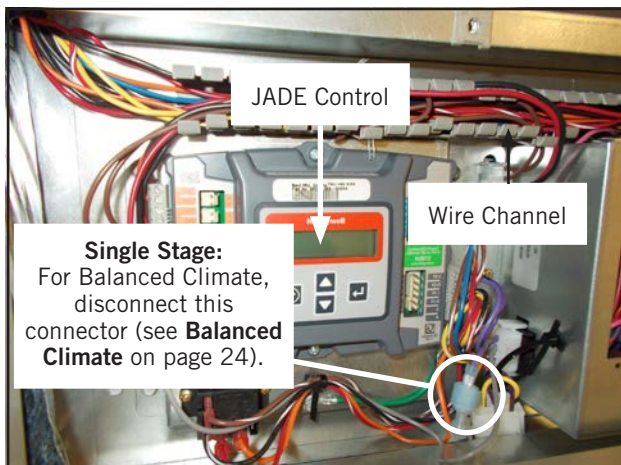

2-Stage Units Only

For 2-stage units, balanced climate is unavailable.

Disconnect the 2-stage harness wire from blue jumper wire secured to the low voltage box. Also, disconnect the yellow and purple wires on the vent plug as shown in Figures 8 and 9.

Connect the purple wire from the vent plug to the 2-stage harness (wire is blue for standard units and orange/white for dehumidification units). Tape off the yellow and blue wires that are not used as shown in Figure 9.

FIGURE 8
Install 910-2063 Control Board Assembly
(W*SAC 2-Stage Units)

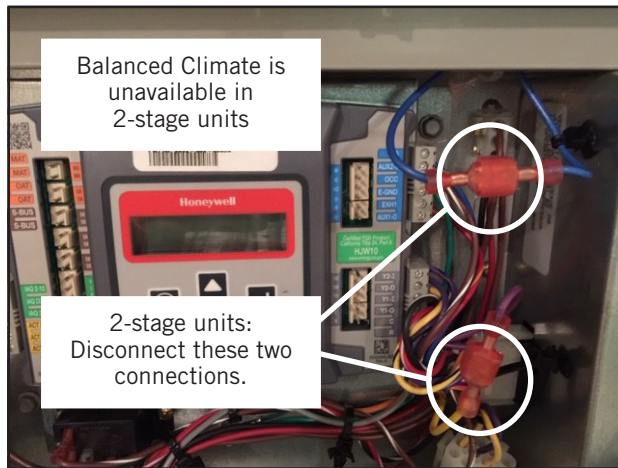
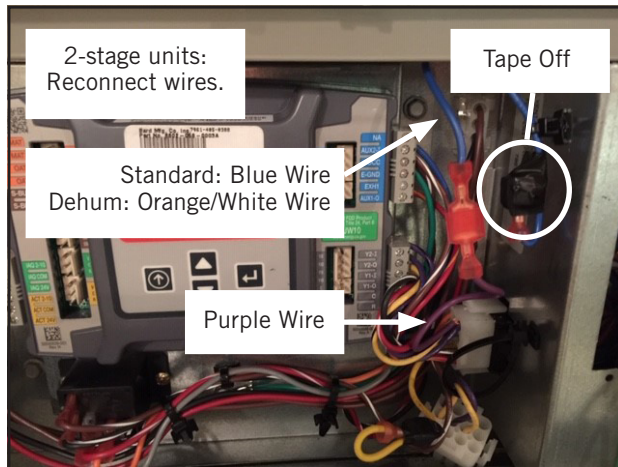

FIGURE 9
W*SAC 2-Stage Unit Wire Connection



Before installing the economizer, remove economizer from packaging and verify there is no damage. Install the economizer as shown in Figure 10.

Set economizer on the exhaust partition (see Figure 5) and slide in until flush with the side of the wall mount.

FIGURE 10
Install Economizer



When the economizer is fully installed, the control plug should be centered in the plug access opening on the front panel of the economizer as shown in Figure 11.

FIGURE 11
Control Plug Centered in Plug Access Opening

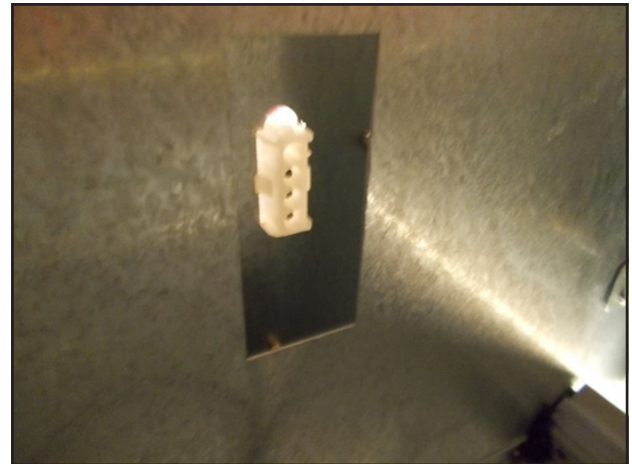

From the front, through the filter opening, plug the economizer power plug into the control panel plug (see Figure 12).

IMPORTANT: Sharp edges--PPE required.

FIGURE 12
Connect Economizer Power Plug to Control Panel Plug

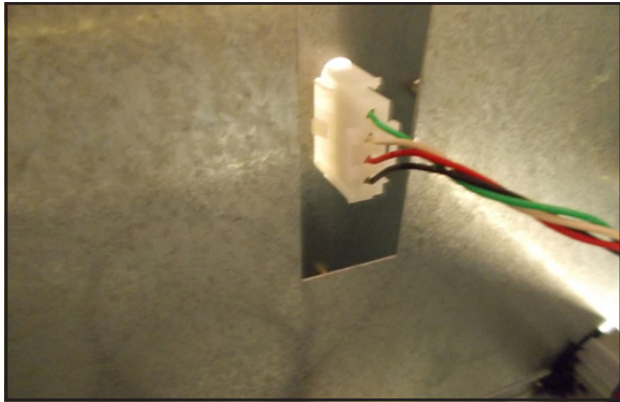

Install the indoor mixed air sensor assembly in the location shown in Figure 13, just to the right of the indoor blower. Use two (2) #10-16x1/2 screws (supplied) to mount the sensor.

FIGURE 13
Install Indoor Mixed Air Sensor Assembly



Route the orange mixed air sensor wires up through the control panel, circuit breaker panel and blower partition as shown in Figure 14.

FIGURE 14
Route Orange Mixed Air Sensor Wires

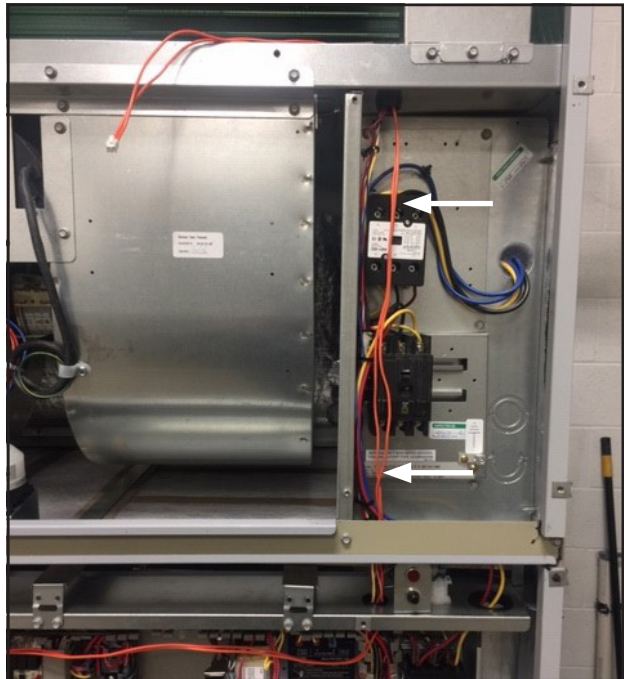

Secure wires with provided ladder ties (see Figure 15).

FIGURE 15
Secure Sensor Wires with Ladder Ties



Connect sensor plug as shown in Figure 16.

FIGURE 16
Connect Mixed Air Sensor Plug



Install the 910-1980 enthalpy sensor assembly (Figure 17) or 910-1898E temperature only sensor (Figure 18) using two (2) #10-16x1/2 screws (supplied). Fasten cable to the back with one (1) provided push wire tie.

FIGURE 17
Enthalpy Sensor Assembly Installation



FIGURE 18
Temperature Only Sensor Assembly Installation



Route wires over the top of the outdoor fan motor up through the condenser partition wire bushing as shown in Figure 19. Secure cable with provided ladder ties.

FIGURE 19
Route Wires and Secure with Ties



Route the cable up through the control panel bushing and secure with provided ladder tie (see Figure 20).

FIGURE 20
Route Cable Through Control Panel Bushing

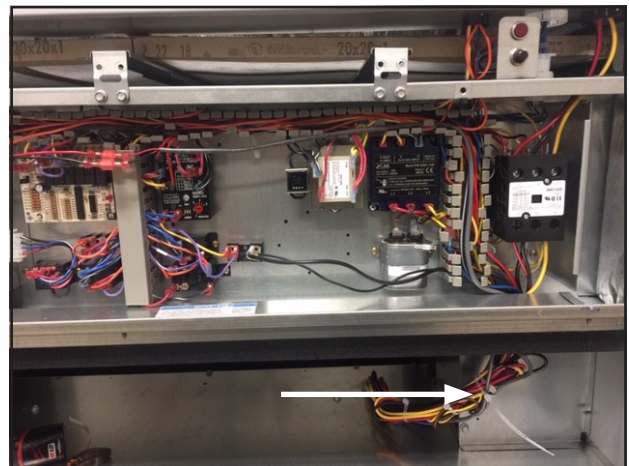

Route the cable into the wire channel (cover removed earlier) and connect to the red and black wires from the JADE controller (see Figure 21).

FIGURE 21
Route Cable and Connect to Red and Black Wires

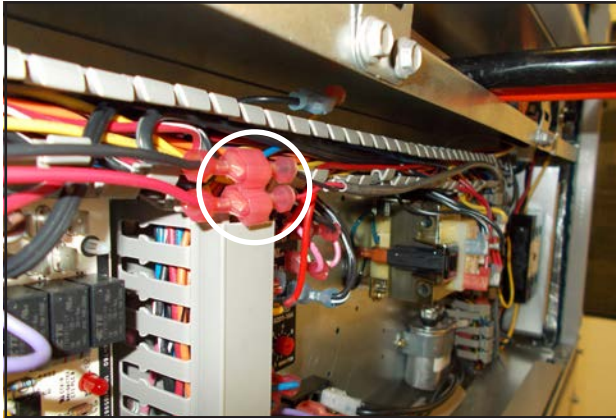

Re-install wire channel covers; make sure all wires are contained inside the channel as shown in Figure 22.

Install the electrical entrance door and upper blower door.

FIGURE 22
Wiring Connections Completed

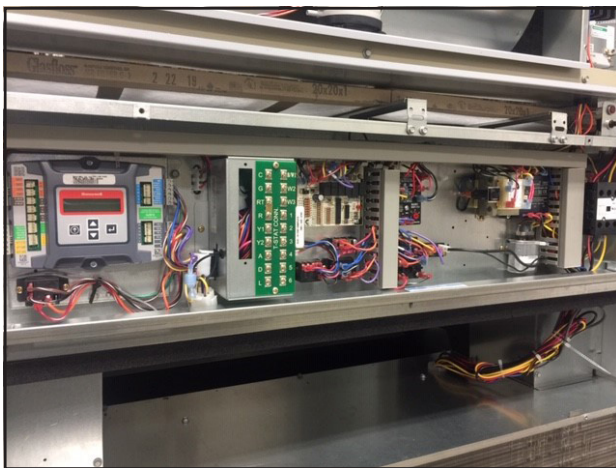

The ECON-WD5 exhaust blade is fixed in the shipping position by the latch located on the bottom of the blade (see Figure 23). Access can be made through the return air opening or through the opening under the economizer. Turning the latch 1/4 turn will release the blade.

FIGURE 23
Release the Exhaust Blade



Make sure the blade seats correctly over the exhaust opening and that the latch is as shown in Figure 24.

FIGURE 24
Exhaust Blade and Latch



Install the 539-405 intake sealing frame and the 543-223 lower block off plates (both sides) as shown in Figure 25. Install two (2) 1913-002-0708 7-1/2" foam gaskets below the intake sealing frame (both sides).

FIGURE 25
Install Intake Sealing Frame and Lower Block Off Plates

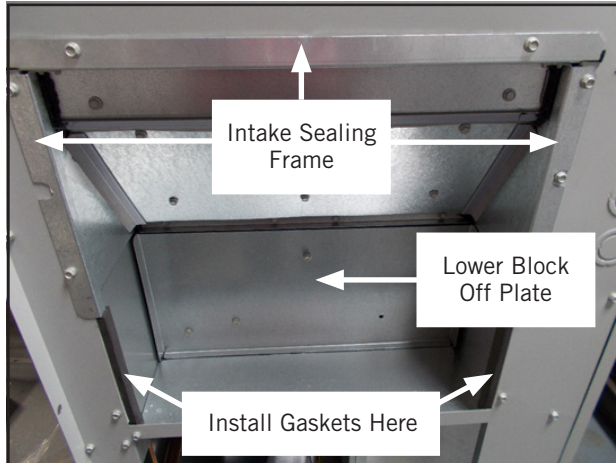

Bend the two (2) sheet metal tabs in the condenser partition up to hold the bottom of the mist eliminator in place.

Install 7003-084 mist filters on both sides (see Figure 26). Then re-install the side grilles removed earlier.

FIGURE 26
Install Mist Filters



Bend the two (2) sheet metal tabs in the condenser partition up to hold the bottom of the bug screen in place. Install two (2) 1913-002-0808 8-1/2" foam gaskets to sides of cabinet (see Figure 27). Install the 7003-083 exhaust bug screen. Re-install front lower (condenser) grille.

FIGURE 27
Install Bug Screen and Gaskets

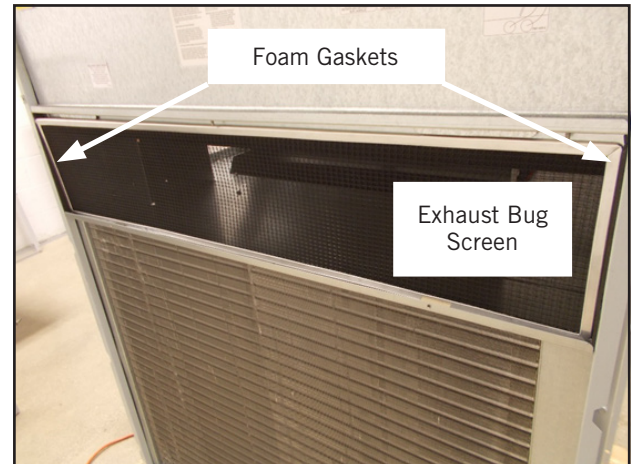

Install both filters, then re-install the inner control panel, outer control panel and upper blower door.

Restore power to unit.

Refer to **START-UP/CHECKOUT PROCEDURES** on page 12.

Blade Adjustment for Desired Ventilator Air

The amount of ventilation air supplied by the economizer is dependant on four factors.

1. Return air duct static pressure drop.
2. Supply air duct static pressure drop.
3. Indoor blower motor speed.
4. Damper blade open position setting.

Refer to the appropriate graph on pages 32 – 34 to determine minimum blade position settings.

using the UP/DOWN buttons. The default enthalpy curve is ES3. The range of this setting is ES1 to ES5. Bard recommends gradual adjustment of the enthalpy curve setting if adjustment is necessary. A higher enthalpy curve setting will result in greater energy savings, but will allow additional humidity into the indoor area. A lower enthalpy curve setting will result in lower humidity being allowed into the indoor area, but will result in less economizer operation. It is always important to consider the indoor requirements while maximizing economizer run time when adjusting the enthalpy curve setting. Once adjustment is made, monitor indoor conditions to verify the desired result.

Minimum Position Setting

Minimum position allows the user to program a blade setting that will allow a certain amount of outdoor air to enter the structure. Minimum blade ventilation occurs when the "A" terminal is energized on the wall mount unit low voltage terminal strip. The blade setting is based on a voltage that is sent to the actuator motor. To adjust the minimum blade position in the JADE controller that will initiate economizer operation, navigate to the SETPOINTS menu using the UP/DOWN buttons. Next, navigate to the MIN POS menu using the UP/DOWN buttons. The default minimum position setting is 2V (closed). The voltage range is 2-10VDC, where 2VDC is a minimum amount of outdoor air being brought into the building and 10VDC is the maximum amount. Charts are provided in this manual to indicate an airflow amount that will be brought into the building at the various voltage settings. Pressure relief is also provided with the economizer, and during operation, a slight positive pressure will be present in the structure. Additional room pressure relief may be required to achieve a 0" W.C. room pressure. A 6VDC to 10VDC minimum position setting is not recommended for normal unit operation. A 10VDC setting may be used if minimum position is to be used to provide emergency cooling operation when the "A" terminal is energized. The emergency cooling feature is available using the MC4002, MC5300 or MC5600 controller. Always make sure unit cooling and heating capacity requirements include fresh air entering the structure.

Low Outdoor Temperature Compressor Lockout

The JADE controller has the ability to disable refrigerant compressor cooling at a certain outdoor temperature. The JADE will monitor the outdoor temperature measurement using the outdoor sensor. When the outdoor temperature reading is below the compressor lockout temperature, the JADE will not call for compressor cooling operation and only use the economizer. This applies if Y1 or Y2 is energized. Refrigerant cooling with compressor use during extremely cold outdoor temperatures may shorten compressor life. To adjust the compressor lockout in the JADE controller that will disable compressor

operation, navigate to the SETPOINTS menu using the UP/DOWN buttons. Next, navigate to the LOW T LOCK menu using the UP/DOWN buttons. The default minimum compressor lockout setting is 0°F (-17.7°C). The outdoor temperature range is -45°F (-42.7°C) to 80°F (26.6°C).

Mixed Air Temperature Setting

As the economizer opens, indoor room air is mixed with the outdoor air entering the wall mount unit. The amount of indoor room air that is mixed with the outdoor air is dependent on the mixed air setpoint. During operation, the economizer will adjust the blade position to maintain a mixed air temperature. Bard has pre-programmed a mixed air temperature that allows for optimized cooling and energy savings while allowing for concurrent economizer and refrigerant compressor cooling. It is strongly recommended that for general use the mixed air temperature be kept at the default value. Adjustments may result in the indoor evaporator coil freezing or lower economizer cooling capacity. To adjust the mixed air setpoint in the JADE controller, navigate to the SETPOINTS menu using the UP/DOWN buttons. Next, navigate to the MAT SET menu using the UP/DOWN buttons. The default mixed air setting is 53°F (11.6°C). The mixed air temperature range is 38°F (3.3°C) to 65°F (18.3°C).

Quick Start Economizer Operational Checkout (CHECKOUT Menu)

It is always important to verify equipment functionality when using equipment to provide cooling to a space with equipment or occupants. A few simple steps will ensure that the economizer is functioning properly in the unit and will provide optimum performance. The following is provided as a basic checklist and additional steps may be required for advanced applications.

Checkout Procedure

- Make sure the unit power is OFF. Visually inspect the economizer assembly including the seals around the damper blade, damper motor linkage and wire harnesses are snug that connect the JADE.
- Review location of outdoor temperature sensor. The outdoor temperature sensor is located at the bottom left corner of the unit in the condenser area (see installation instructions). If the unit is located or installed in a way that the sensor will not be able to accurately read the outdoor temperature, it may need to be re-routed outside the unit cabinet.
- Apply power to the unit. Wait a few minutes for the JADE to energize. Verify no alarms are present on the JADE display. Next, navigate to the CHECKOUT menu using the UP/DOWN buttons. Once in the checkout menu, select the following:
 - o DAMPER OPEN: This will force the economizer blade to open. Verify damper motor and linkage are functional.

- o DAMPER CLOSE: This will force the economizer blade to close. Verify damper blade seals in the closed position.
- o CONNECT Y1-O: This will force compressor cooling to operate. When energized, it may take several minutes for the compressor to energize.
- After completing checkout procedures, it is important that all panels are re-installed and secured before product use.

JADE Economizer Control Advanced Setup

Review/Customize System Setup

Before being placed in service, the JADE economizer controller programming should be reviewed/customized through the following steps:

1. **SYSTEM SETUP:** from the main screen, press the **SCROLL (UP/DOWN) BUTTONS** to navigate through the six (6) basic menu items to the **SYSTEM SETUP** menu.

- Push the **SELECT (ENTER) BUTTON** to choose the **SYSTEM SETUP** menu.
- Navigate through the multiple levels of **SYSTEM SETUP** by pushing the **SCROLL (UP/DOWN) BUTTONS**.
- To change a specific parameter in the **SYSTEM SETUP** menu, press the **SELECT (ENTER) BUTTON** to display its current value. Press the **SCROLL (UP/DOWN) BUTTONS** to change or increase/decrease value. Press the **SELECT (ENTER) BUTTON** to save the new customized value—“CHANGE STORED” will be displayed. Press the **SELECT (ENTER) BUTTON** again to return to current menu parameter.
- For specific **SYSTEM SETUP** level information, refer to **TABLE 1**.

NOTE: During an extended level of inactivity, the display of the JADE economizer controller will begin to automatically scroll through the various levels of the STATUS menu as a screensaver. Each level will stay for approximately 5 seconds before changing to the next level.

TABLE 1
System Setup Menu Levels

Menu Level	Default Value	Range	Notes
INSTALL	01/01/10		Display Order = MM/DD/YY Setting Order = DD/MM/YY
UNITS DEG	°F	°F / °C	Sets controller to read in either measurements
EQUIPMENT	HP(B)	HP	Heat Pump HP * CONV = A/C
AUX IN	HP(B)	HP(O) HP(B)	Energize on Cool * Energize on Heat
FAN SPEED	1 Speed	1 Speed 2 Speed	
FAN CFM	5000	100 to 15000	Not applicable
AUX OUT	EXH2	NONE ERV EXH2 SYS	Product can be used to signal other devices
OCC	INPUT	INPUT or ALWAYS	INPUT is for dedicated OCC signal, ALWAYS is for all other situations
FACTORY DEFAULT	NO	YES or NO	Resets to factory defaults if changed to YES

* In SYS SETUP, the correct Equipment setting is HP and for the AUX2 IN is HP (B) in all applications. This is correct for both air conditioner and heat pump equipment in order to have correct operating sequences for the economizers. DO NOT change to CONV = A/C setting just because the equipment is an air conditioner and not a heat pump.

2. **ADVANCED SETUP:** from the main screen, press the **SCROLL (UP/DOWN) BUTTONS** to navigate through the six (6) basic menu items to the **ADVANCED SETUP** menu.

- Push the **SELECT (ENTER) BUTTON** to choose the **ADVANCED SETUP** menu.
- Navigate through the multiple levels of **ADVANCED SETUP** by pushing the **SCROLL (UP/DOWN) BUTTONS**.
- To change a specific parameter in the **ADVANCED SETUP** menu, press the **SELECT (ENTER) BUTTON** to display its current value. Press the **SCROLL (UP/DOWN) BUTTONS** to change or increase/decrease value. Press the **SELECT (ENTER) BUTTON** to save the new customized value—“CHANGE STORED” will be displayed. Press the **SELECT (ENTER) BUTTON** again to return to current menu parameter.
- For specific **ADVANCED SETUP** level information, refer to **TABLE 2**.

TABLE 2
Advanced Setup Menu Levels

Menu Level	Default Value	Range	Notes
MA LOW SET	45°F	35-55°	Temp to activate freeze protection — Close Damper
FREEZE POS	CLO	CLO or MIN	Damper position upon freeze protection
STG3 DLY	15 MIN	0 to 4.0h or OFF	Delay for 3rd Stage Cooling – allows for 3 stages of cooling, one stage for econ & two stages for compressor
DMPR POS	CLO	CLO or OPN	Where damper goes upon shutdown signal
MA T CAL	0.0°F	+/-2.5°F from actual reading	Mixed Air Sensor temperature calibration
OA T CAL	0.0°F	+/-2.5°F from actual reading	Outdoor Air Sensor temperature calibration
OAS H CAL	0%	+/-10% from actual reading	Outdoor Air Humidity Sensor calibration for economizers using temp/humidity sensor

3. **SETPOINTS:** from the main screen, press the **SCROLL (UP/DOWN) BUTTONS** to navigate through the six (6) basic menu items to the **SETPOINTS** menu.

- Push the **SELECT (ENTER) BUTTON** to choose the **SETPOINTS** menu.
- Navigate through the multiple levels of **SETPOINTS** by pushing the **SCROLL (UP/DOWN) BUTTONS**.
- To change a specific parameter in the **SETPOINTS** menu, press the **SELECT (ENTER) BUTTON** to display its current value. Press the **SCROLL (UP/DOWN) BUTTONS** to change or increase/decrease value. Press the **SELECT (ENTER) BUTTON** to save the new customized value—“**CHANGE STORED**” will be displayed. Press the **SELECT (ENTER) BUTTON** again to return to current menu parameter.
- For specific **SETPOINTS** level information, refer to **TABLE 3**.

TABLE 3
Setpoints Menu Levels

Menu Level	Default Value	Range	Notes
MAT SET	53°F	38°F to 65°F	Mixed Air Temperature setpoint at which the economizer damper will begin to modulate to maintain setting
LOW T LOCK	0°F	-45°F to 80°F	Low outdoor ambient temperature for compressor lockout
DRYBLB SET	60°F	48°F to 80°F	Maximum outdoor temperature setting for “free” economizer cooling
ENTH CURVE	ES3	ES1, ES2, ES3, ES4 or ES5	Enthalpy boundary “curves” for economizers using temp/humidity sensor, see Enthalpy Settings on page 18
MIN POS	2V	2 to 10 VDC	Actuator voltage for Minimum Position – see Minimum Position Note on page 16
EXH1	50%	0 to 100%	Setpoint for damper if exhaust fan is powered by economizer
EXH2	6%	0 to 100%	Setpoint for AUX output signal
DCV SET (See NOTE under Table 6 on page 17)	1100	500 to 2000	Displays only if a CO ₂ sensor is connected. Setpoint for Demand Control Ventilation of space. Above the setpoint, the OA dampers will modulate open to bring in additional OA to maintain a space ppm level below the setpoint.

MINIMUM POSITION NOTE: Minimum position is preset to 2V which will need changed to 10V when connected to MC4002 Lead/Lag Controller System to allow economizer to drive wide open per emergency ventilation strategy as detailed in MC4002 Instructions.

4. **CHECKOUT:** from the main screen, press the **SCROLL (UP/DOWN) BUTTONS** to navigate through the six (6) basic menu items to the **CHECKOUT** menu.

- Push the **SELECT (ENTER) BUTTON** to choose the **CHECKOUT** menu.
- Navigate through the multiple levels of **CHECKOUT** by pushing the **SCROLL (UP/DOWN) BUTTONS**.
- To perform a specific test in the **CHECKOUT** menu, press the **SELECT (ENTER) BUTTON** to choose a particular exercise, “**RUN?**” will appear. Press the **SELECT (ENTER) BUTTON** again to activate this exercise. After a short pause, “**IN PROGRESS**” will appear as the test activates. “**DONE**” will display after the test is complete. Press the **MENU UP (EXIT) BUTTON** to end the test and/or turn off the activated relay.
- For specific **CHECKOUT** level information, refer to **TABLE 4** on page 16.

NOTE: CHECKOUT functions bypass the normal 5-minute delay for compressor protection. Be sure to allow for enough time to pass between tests so the compressor is not damaged from extreme short-cycling.

TABLE 4
Checkout Menu Levels

Menu Level	Notes
DAMPER VMIN-HS	Positions damper to the minimum amount of opening allowed by actuator
DAMPER VMAX-HS	Opens damper to the MIN POS level indicated in the SETPOINTS menu. See Minimum Position Note above.
DAMPER OPEN	Forces damper to full open position, energizes exhaust contacts
DAMPER CLOSE	Positions damper to completely closed position
CONNECT Y1-O	Forces Y1-OUTPUT to compressor
CONNECT Y2-O	Forces Y2-OUTPUT to compressor
CONNECT AUX	Depending upon AUX OUT setting from SETUP menu: NONE – no action ERV – 24VAC out for ERV & NOT Economizer SYS – 24VAC out for alarm

NOTE: Economizer assembly should be ready to put into service. At any point during operation, in economizer mode or idle, real-time information from sensors and integral components can be accessed from the **STATUS** menu.

5. **STATUS:** from the main screen, press the **SCROLL (UP/DOWN) BUTTONS** to navigate through the six (6) basic menu items to the **STATUS** menu.

- Push the **SELECT (ENTER) BUTTON** to choose the **STATUS** menu.
- Navigate through the multiple levels of **STATUS** by pushing the **SCROLL (UP/DOWN) BUTTONS**.
- As the **STATUS** menu simply gives input/output information in real-time, there is no way to change or otherwise alter the displayed criteria. It is simply a window into the operation of the economizer controller.
- For specific **STATUS** level information, refer to **TABLE 5**.

NOTE: Upon power-up (or after power failure or low voltage condition), the controller will begin a 5-minute time delay before enabling mechanical cooling.

TABLE 5
Status Menu Levels

Menu Level	Default Value	Notes
ECON AVAIL	YES/NO	Indicates if conditions are favorable for economizing
ECONOMIZING	YES/NO	Indicates if economizer is actively economizing
OCCUPIED	YES/NO	Indicates if dedicated 24V occupied signal is being received on terminal OCC
HEAT PUMP	COOL/HEAT	Displays actual compressor use if in HEAT PUMP mode
COOL Y1-IN	ON/OFF	Indicates if 24V signal is being received on terminal Y1-I
COOL Y1-OUT	ON/OFF	Displays if controller is actively calling for mechanical compressor cooling (24V on Y1-O)
COOL Y2-IN	ON/OFF	Indicates if 24V signal is being received on terminal Y2-I
COOL Y2-OUT	ON/OFF	Displays if controller is actively calling for Stg. 2 cooling (24V on Y2-O)
MA TEMP	0° to 140°F	Current mixed air temp
OA TEMP	-40° to 140°F	Current outdoor air temp
OA HUM	0% to 100%	Current outdoor air humidity for economizers using temp/humidity sensor
DAMPER OUT	2.0 to 10.0	Displays voltage to actuator
ACT POS	0 to 100%	Current % of opening
ACT COUNT	N/A	Current count of actuator cycles from installation
ACTUATOR OK	YES/NO	Indicates potential fault
EXH1 OUT	ON/OFF	Output of EXH1 Terminal
MECH COOL ON	0, 1, or 2	Stages of mechanical cooling currently active

NOTE: If there are any potential problems recognized by the economizer controller, it may be registered in the form of an alarm in the **ALARM(S)** menu. If there is a period of inactivity AND there is an alarm registering, the controller will randomly scroll through the **ALARM(S)** menu items as a screensaver.

ALARM(S): from the main screen, press the **SCROLL (UP/DOWN) BUTTONS** to navigate through the six (6) basic menu items to the **ALARM(S)** menu.

- Push the **SELECT (ENTER) BUTTON** to choose the **ALARM(S)** menu.
- Navigate through the current alarms in **ALARM(S)** by pushing the **SCROLL (UP/DOWN) BUTTONS**.
- Once the alarm has been identified, and the cause has been removed (e.g., replaced faulty sensor), the alarm may erase itself. If a manual alarm-erasing is required, it can be cleared from the display by navigating to the desired alarm and pressing the

SELECT (ENTER) BUTTON to choose that specific alarm. “**ERASE?**” will display. Press the **SELECT (ENTER) BUTTON** again. “**ALARM ERASED**” will appear. Press the **MENU UP (EXIT) BUTTON** to complete the action and return to the previous menu.

- For specific **ALARM(S)** information, refer to **Table 6**.

TABLE 6
Alarm Examples

Alarm(s)	Notes
MA T SENS ERR	Malfunctioning mixed air sensor
OA T SENS ERR	Malfunctioning outdoor air sensor
ACT STALLED	Actuator cannot reach desired percentage of opening
SYS ALARM	If AUX is set to SYS in SETPOINTS menu, SYS will display upon any registered alarm
NOTE: This is not a complete list of alarms. Additional alarms will display depending upon the parameter settings and configuration and attached equipment.	

NOTE: When using the Bard 8403-096 CO₂ controller, configure the sensor to 2-10VDC output (see CO₂ sensor instructions).

The JADE controller default setting is 1100 PPM. The economizer will modulate to maintain this CO₂ level in the room. The default setting can be changed in the SETPOINT menu in the DCV SET option. Default settings and DCV MIN and DCV MAX will appear only when the CO₂ sensor is connected.

In the SETPOINT menu, change the MAX VENT setting to 9.5 volts.

The CO₂ controller is active at any time the A terminal is energized.

The status of the CO₂ input can be viewed at any time in the STATUS menu.

Enthalpy Settings

If economizer is enthalpy-based and was shipped with the temp/humidity sensor, the economizer must be programmed for the specific enthalpy curve boundary desired for “free” outdoor cooling. The available enthalpy boundaries are all subject to specific OA temperature, OA humidity and OA dew points. If all of the OA conditions are below the specific points outlined in each boundary, the conditions are good to economize and economizer mode is set to “YES”. If some or all the OA conditions are above the specific points outlined in each boundary, the conditions are not good to economize and the economizer mode is set to “NO”.

ES3 is factory default.

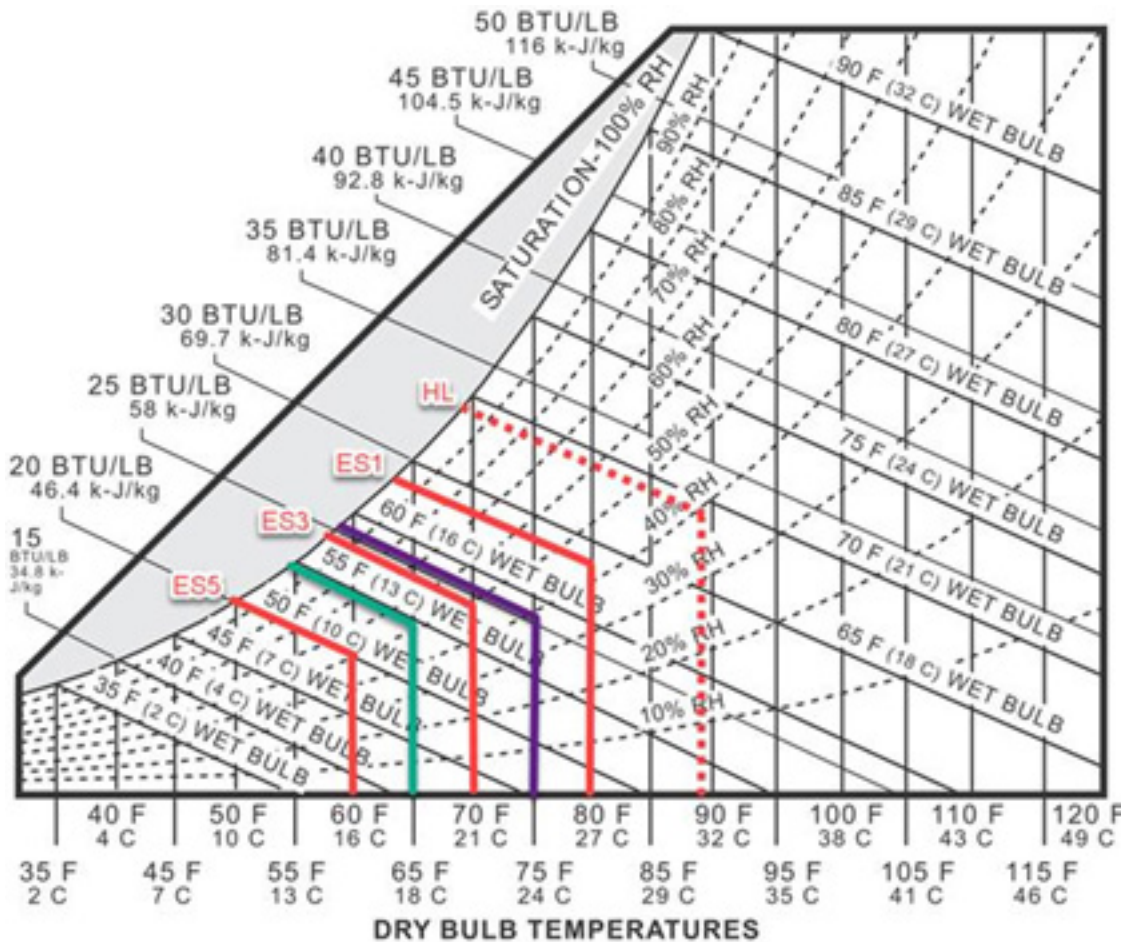
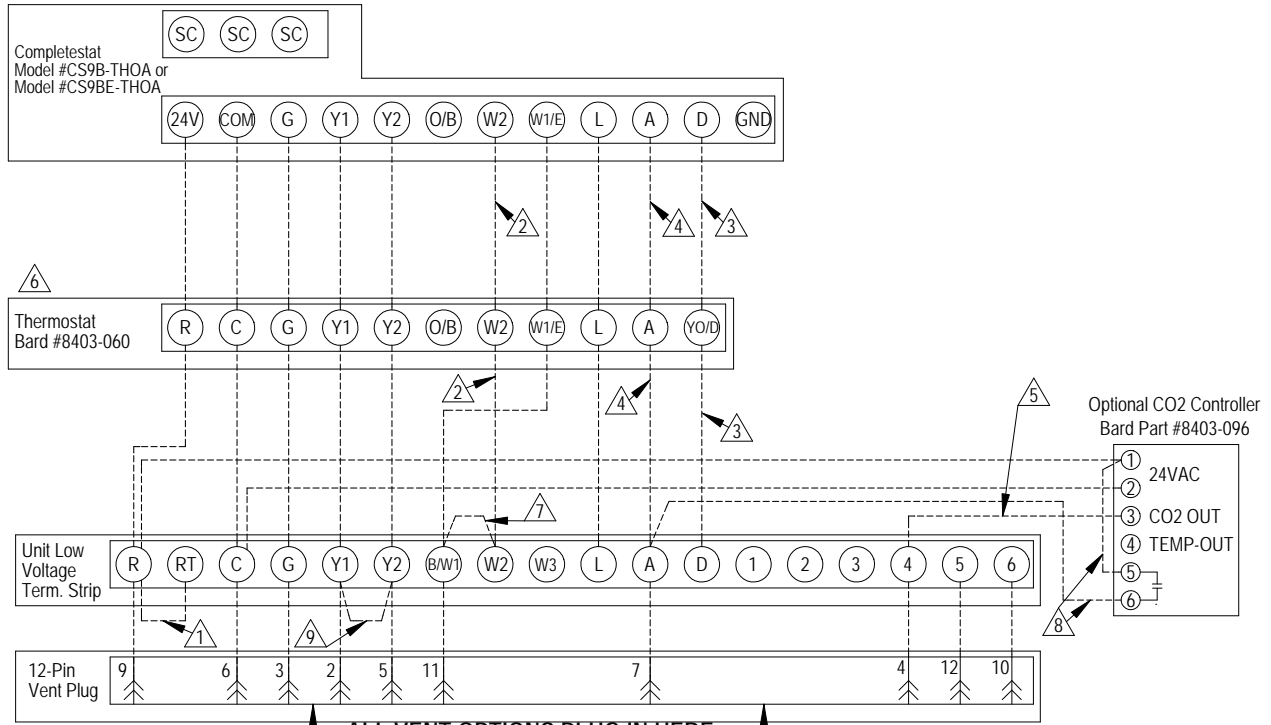

FIGURE 29
Programmable Thermostat Connections for ECON-5 with Single Stage Air Conditioners**



ALL VENT OPTIONS PLUG IN HERE
If not equipped with a ventilation option to plug in, a jumper plug must be installed.

- | | |
|---|---|
| <p>△1 Factory installed jumper. Remove jumper and connect to N.C fire alarm circuit if emergency shutdown required.</p> <p>△2 Wire not needed below 15KW.</p> <p>△3 Wire required for dehumidification models only.</p> <p>△4 Do not connect "A" from thermostat if optional CO2 controller is used</p> <p>△5 0-10 VDC modulating CO2 control signal for modulating ventilation control (optional for ECON only - see vent instruction manuals)</p> | <p>△6 Change model configuration from heat pump to heat/cool. Must be configured to programmable and fan set to be programmed fan for the "A" output to function during scheduled occupied periods. Must be configured for multi-stage for Y1 output to be active 1st stage cooling. For dehumidification, must be configured for "No Economizer" for YO/D to be active for humidity control.</p> <p>△7 Install jumper for 1 stage electric heat on units with more than 10KW</p> <p>△8 Do not add these wires if setting up for modulating control. See note 5.</p> <p>△9 Factory installed jumper. Remove jumper to activate Balanced Climate™ mode. A 2-stage thermostat is recommended for Balanced Climate mode. Y1 Y2 jumper not present if economizer is factory installed. Units with economizers have balanced climate jumper in economizer, refer to economizer manual.</p> |
|---|---|

MIS-3974 D

FIGURE 30
Programmable Thermostat Connections for ECON-5 with 2-Stage Air Conditioners**

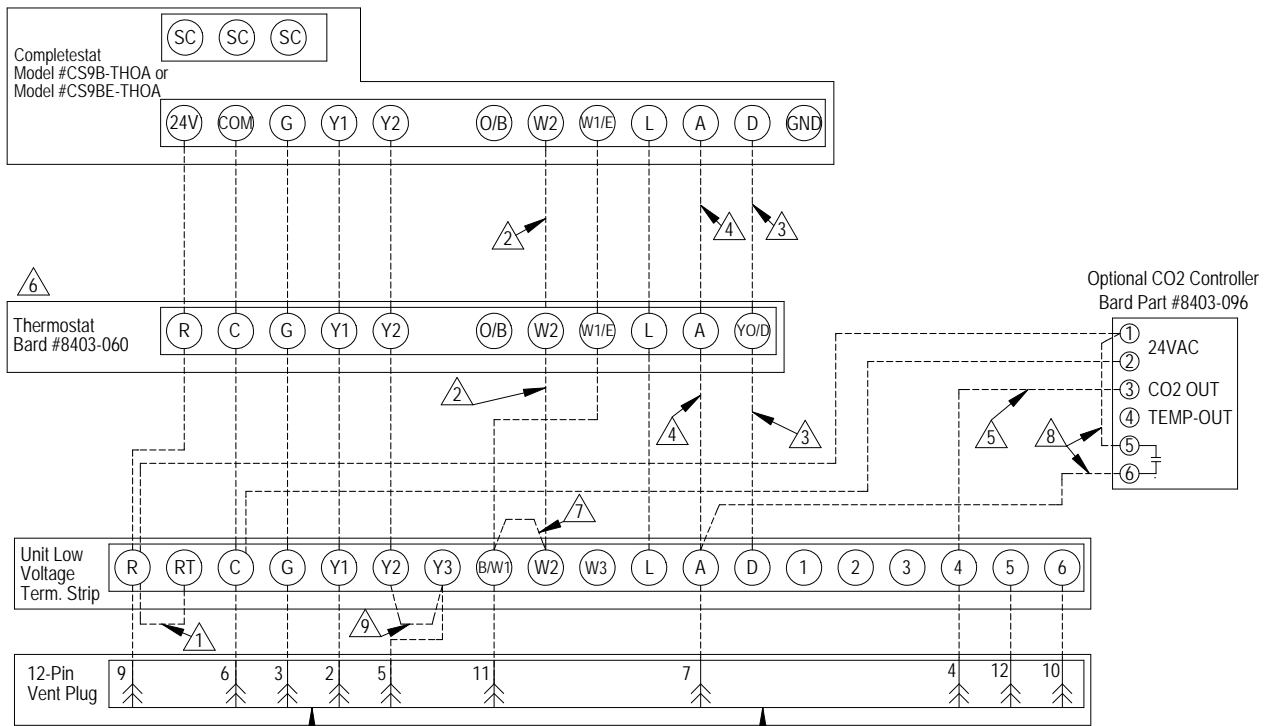

ALL VENT OPTIONS PLUG IN HERE
If not equipped with a ventilation option to plug in, a jumper plug must be installed.

- | | |
|--|--|
| <p>⚠ 1 Factory installed jumper. Remove jumper and connect to N.C fire alarm circuit if emergency shutdown required.</p> <p>⚠ 2 Wire not needed below 15KW.</p> <p>⚠ 3 Wire required for dehumidification models only.</p> <p>⚠ 4 Do not connect "A" from thermostat if optional CO2 controller is used</p> <p>⚠ 5 0-10 VDC modulating CO2 control signal for modulating ventilation control (optional for ECON only - see vent instruction manuals)</p> | <p>⚠ 6 Change model configuration from heat pump to heat/cool. Must be configured to programmable and fan set to be programmed fan for the "A" output to function during scheduled occupied periods. Must be configured for multi-stage for Y1 output to be active 1st stage cooling. For dehumidification, must be configured for "No Economizer" for YO/D to be active for humidity control.</p> <p>⚠ 7 Install jumper for 1 stage electric heat on units with less than 15KW</p> <p>⚠ 8 Do not add these wires if setting up for modulating control. See note 5.</p> <p>⚠ 9 Factory installed jumper. Must not be removed when Econ is installed.</p> |
|--|--|

MIS-4291

FIGURE 31
Programmable Thermostat Connections for ECON-5 with Heat Pumps**

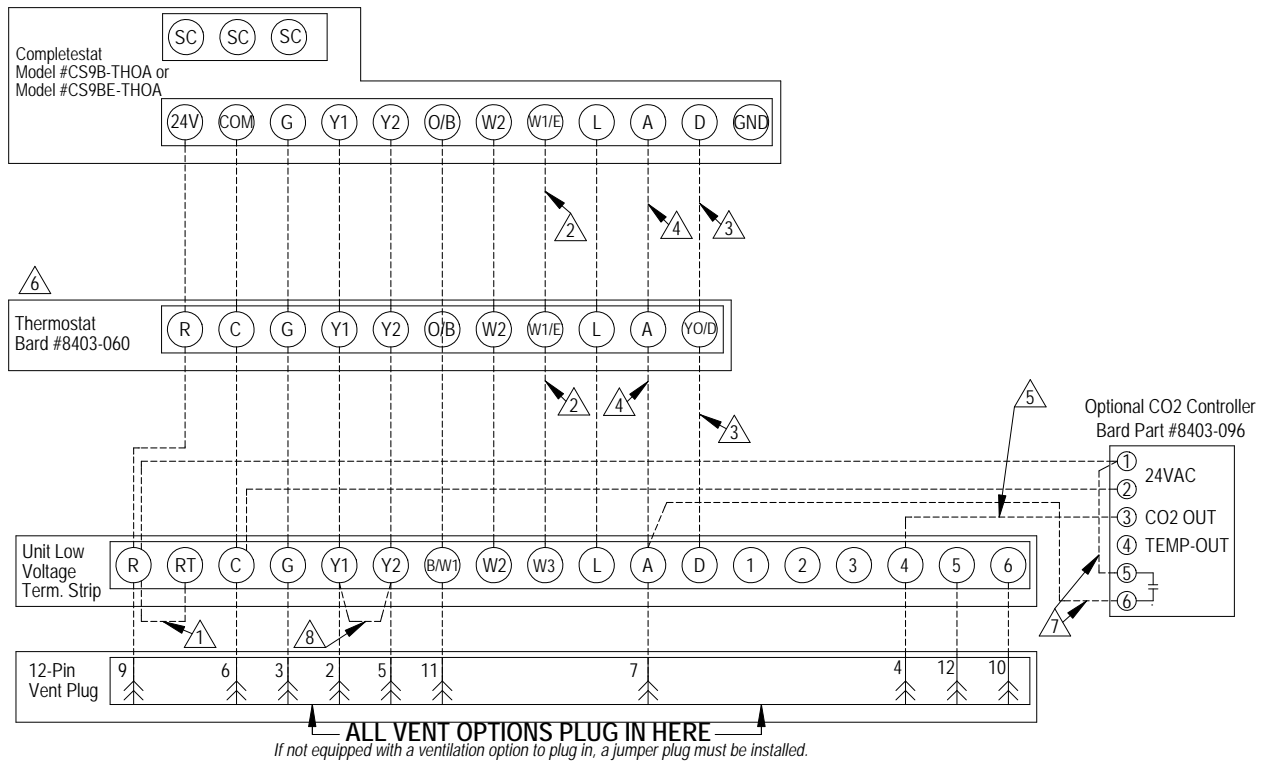

- | | |
|--|--|
| <p>① Factory installed jumper. Remove jumper and connect to N.C fire alarm circuit if emergency shutdown required.</p> <p>② Wire not needed below 15KW.</p> <p>③ Wire required for dehumidification models only.</p> <p>④ Do not connect "A" from thermostat if optional CO2 controller is used</p> <p>⑤ 0-10 VDC modulating CO2 control signal for modulating ventilation control (optional for ECON only - see vent instruction manuals)</p> | <p>⑥ Ensure model configuration is heat pump and not heat/cool. Must be configured to programmable and fan set to be programmed fan for the "A" output to function during scheduled occupied periods. Must be configured for multi-stage for Y1 output to be active 1st stage cooling. For dehumidification, must be configured for "No Economizer" for YO/D to be active for humidity control.</p> <p>⑦ Do not add these wires if setting up for modulating control.</p> <p>⑧ Factory installed jumper. Jumper is not installed on unit with economizers. Jumper is located in jade wiring harness.</p> |
|--|--|

MIS-4063 D

FIGURE 32
Non-Programmable Thermostat Connections for ECON-5 with Air Conditioners**

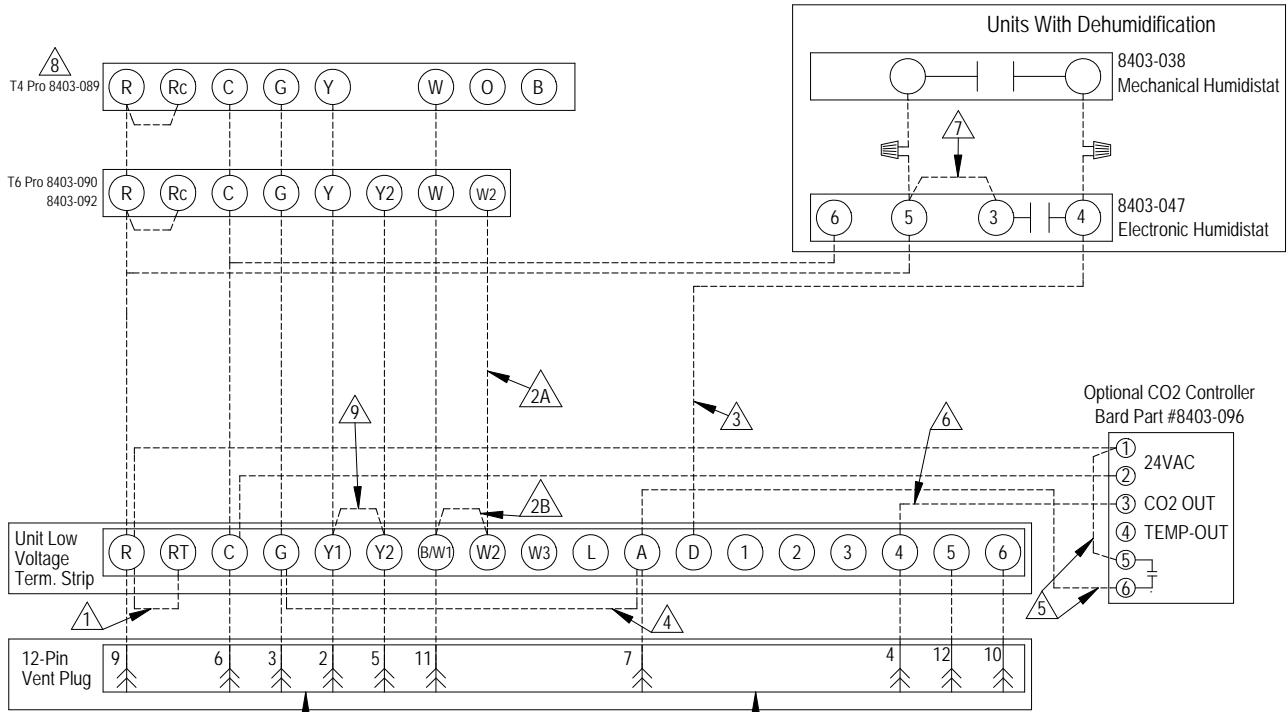

ALL VENT OPTIONS PLUG IN HERE

If not equipped with a ventilation option to plug in, a jumper plug must be installed.

- | | |
|---|--|
| <p>1 Factory installed jumper. Remove jumper and connect to N.C fire alarm circuit if emergency shutdown required.</p> <p>2A Wire not needed below 15KW.</p> <p>2B Install Jumper for 1 stage electric heat on units with more than 10KW.</p> <p>3 Wire required for dehumidification models only.</p> <p>4 For vent operation, add jumper if optional CO2 controller is not used. Vent will run while blower is energized. For ECON & CRV-V an additional wire change is required. See install Manual.</p> <p>5 Do not add these wires if setting up for modulating control. See note 6.</p> | <p>6 0-10 VDC Modulating CO2 control signal for modulating ventilation control (Optional for ECON Only) - See vent installation manual.</p> <p>7 Jumper needs added.</p> <p>8 Thermostat will not work with units equipped with economizers.</p> <p>9 Factory installed jumper. Remove jumper to activate Balanced Climate™ Mode. A 2-stage thermostat is recommended for Balanced Climate mode.</p> |
|---|--|

MIS-3975 D

IMPORTANT NOTE

An additional wire change is required if jumper 4 is used which connects "A" to "G" (shown in Figures 32 and 33). The red/white wire on the blower interlock relay (located on the vent control plate) needs to be moved from the "common" terminal to the "normally closed" terminal. **If this change is not made, the relay will latch on once the "A" signal is received and the blower will not turn off.** Refer to pages 35 and 36 to see the vent wiring diagrams with this change called out.

FIGURE 33
Non-Programmable Thermostat Connections for ECON-5 with Heat Pumps**

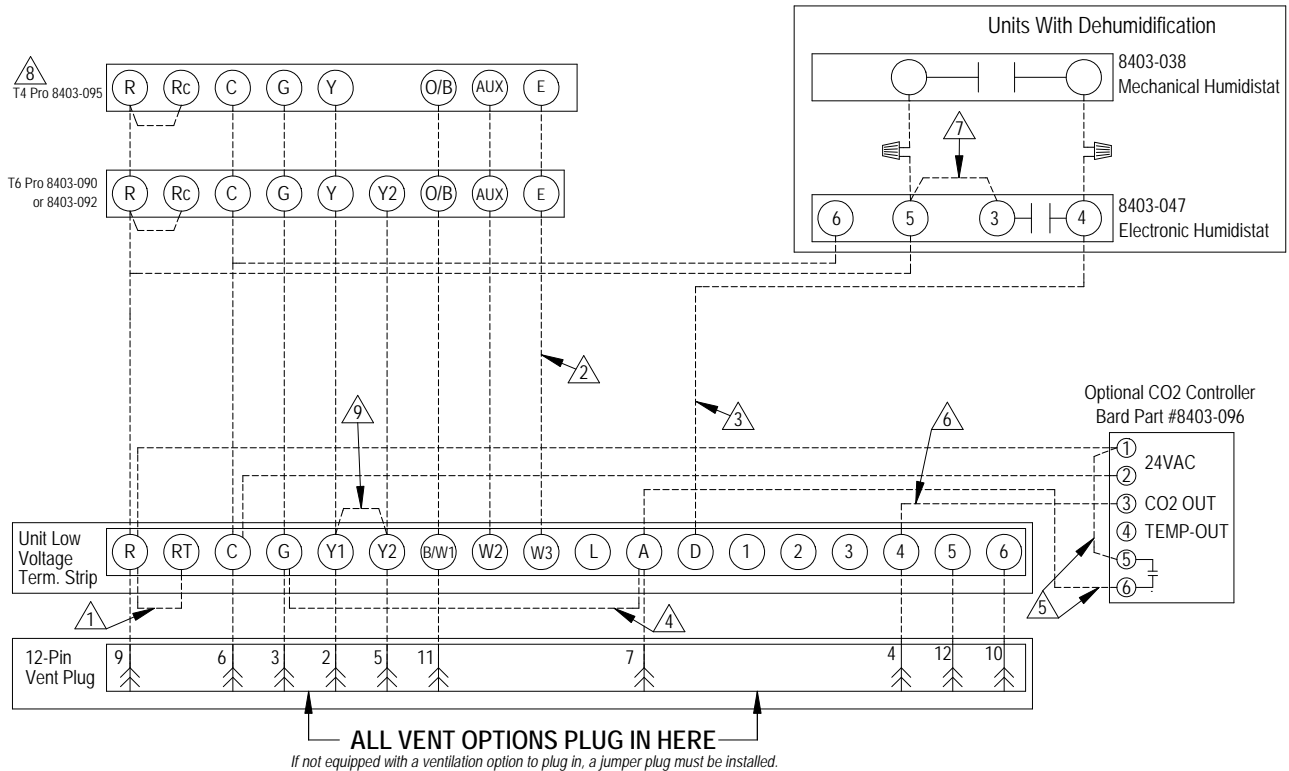

ALL VENT OPTIONS PLUG IN HERE
 If not equipped with a ventilation option to plug in, a jumper plug must be installed.

- 1 Factory installed jumper. Remove jumper and connect to N.C fire alarm circuit if emergency shutdown required.
- 2 Wire not needed below 15KW.
- 3 Wire required for dehumidification models only.
- 4 For vent operation, add jumper if optional CO2 controller is not used. Vent will run while blower is energized. For ECON & CRV-V, an additional wire change is required. See install manual
- 5 Do not add these wires if setting up for modulating control. See note 6.
- 6 0-10 VDC Modulating CO2 control signal for modulating ventilation control (Optional for ECON Only) - See vent installation manual.
- 7 Jumper needs added.
- 8 Thermostat will not work with units equipped with economizers.
- 9 Factory installed jumper. Remove jumper to activate Balanced Climate™ Mode. A 2-stage thermostat is recommended for Balanced Climate mode.

MIS-4064 E

IMPORTANT NOTE

An additional wire change is required if jumper 4 is used which connects "A" to "G" (shown in Figures 32 and 33). The red/white wire on the blower interlock relay (located on the vent control plate) needs to be moved from the "common" terminal to the "normally closed" terminal. **If this change is not made, the relay will latch on once the "A" signal is received and the blower will not turn off.** Refer to pages 35 and 36 to see the vent wiring diagrams with this change called out.

Economizer Sequence of Operation

Condition – Cool/Dry OA Conditions

- 1st Stage Cooling closes and sends signal to JADE control. Since the air temperature outside is cooler than the preset **DRYBULB SET** setting, or is below the **ENTH CURVE** boundary in the **SETPOINTS** menu, the actuator will power the economizer damper to “economizer” mode as the indoor blower motor starts. The mixed air sensor senses a mixture of return air and cool outdoor air and modulates opening to achieve preset **MAT SET** setting in **SETPOINTS** menu. Compressor operation is inhibited (see Figure 34).
- 2nd Stage Cooling closes and sends a signal to JADE control, which closes the Y1-O relay to begin mechanical cooling. **The economizer damper REMAINS OPEN in tandem operation with the compressor** as long as the OA conditions do not drop below the preset **DRYBULB SET/ENTH CURVE** settings in the **SETPOINTS** menu (see Figure 35).
- 3rd Stage Cooling (if available) closes and sends a signal to JADE control, which closes the Y2-O relay to begin 2nd stage mechanical cooling. **The economizer damper REMAINS OPEN in tandem operation with the compressor** as long as the temperature outside does not drop below the preset **DRYBULB SET** setting in the **SETPOINTS** menu (see Figure 35).

FIGURE 34
100% Airflow

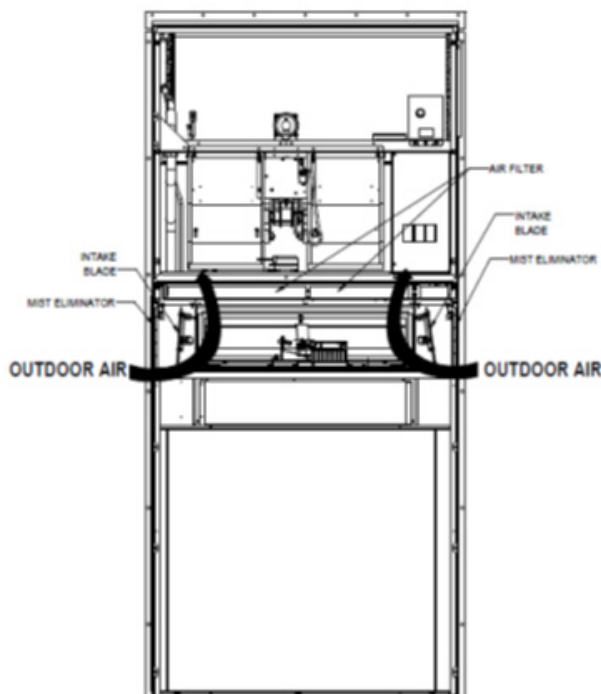

FIGURE 35
Mixed Airflow Path

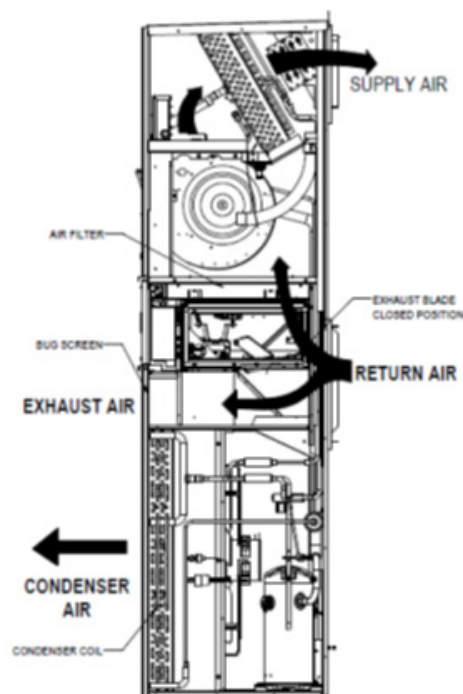
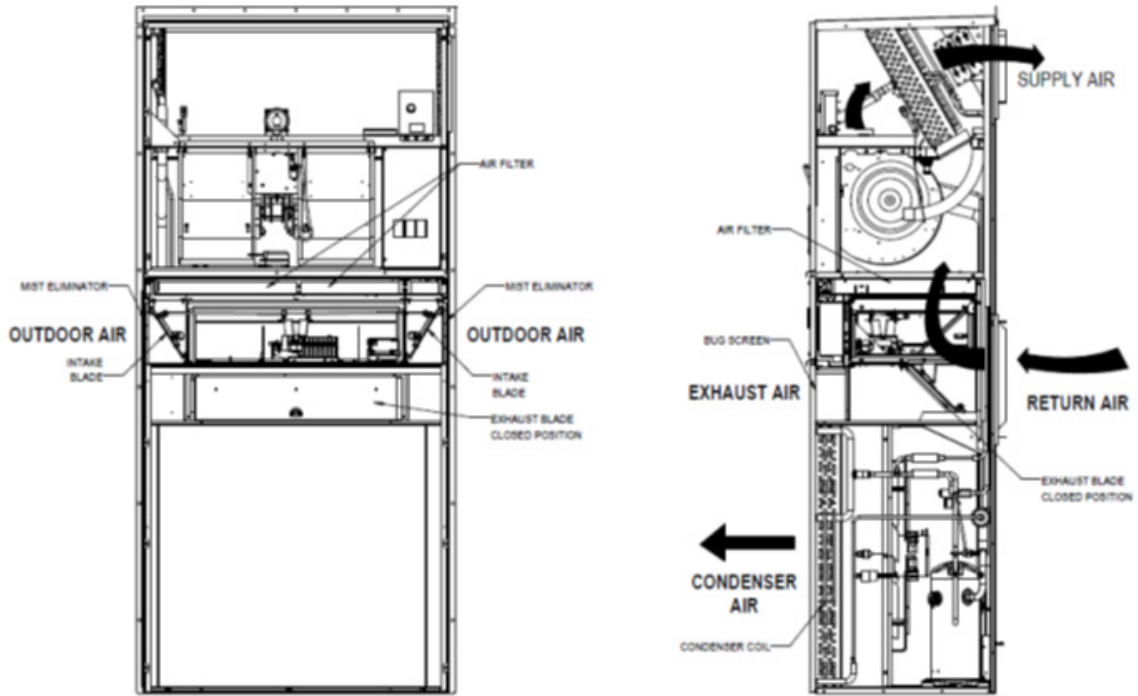
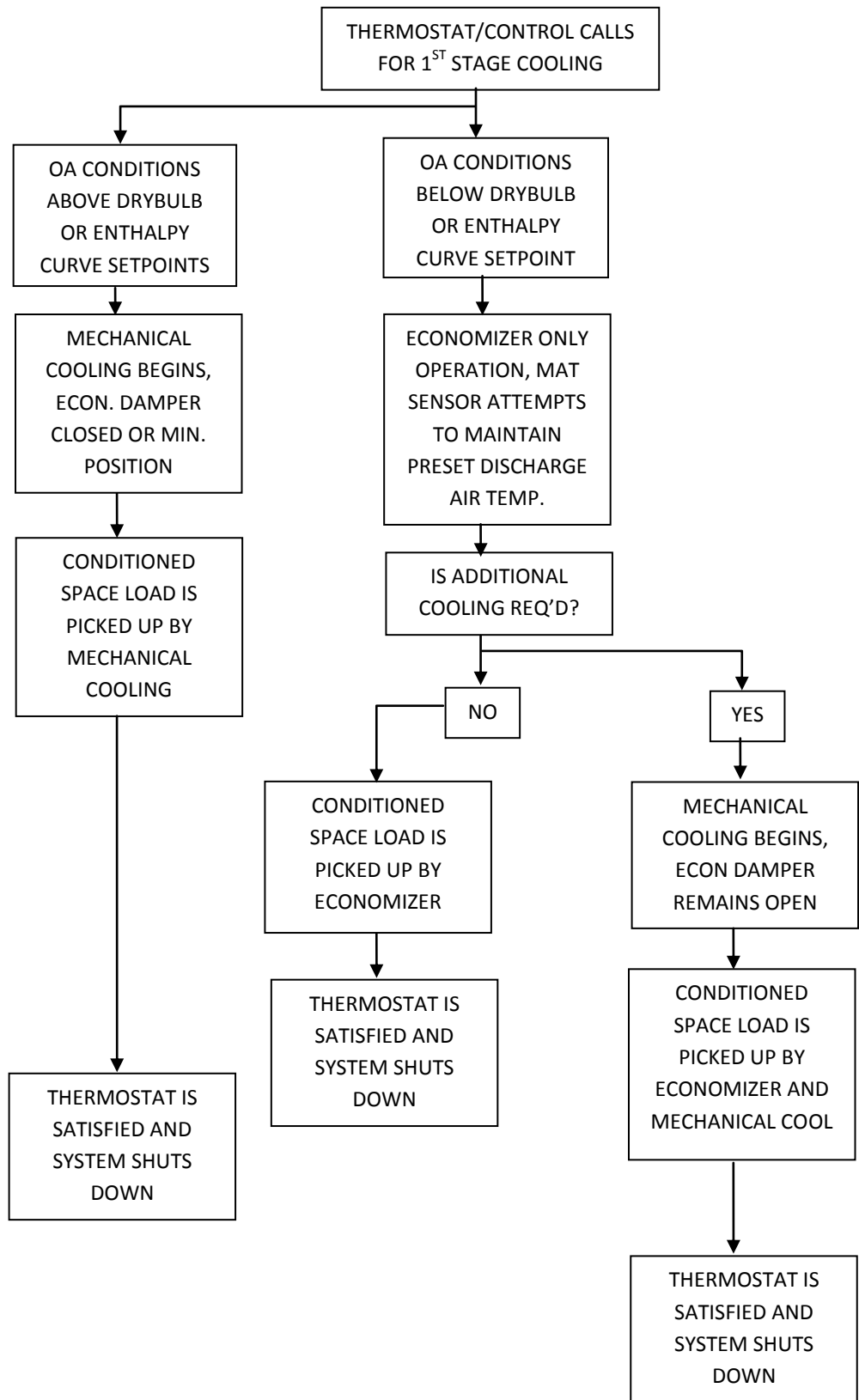

FIGURE 36
Call for Compressor or Fan Only with Ventilation Off



MIC-4037

Economizer Operation for Single Stage:



**Balanced Climate Mode – S, Y and Z Option
Economizer Sequence of Operation**

**Call for cooling and ECONOMIZER IS NOT AVAILABLE
(due to outdoor conditions):**

Y1 energizes mechanical cooling and the Balance Climate fan speed simultaneously. If the outdoor conditions are not acceptable, the Y2 terminal will energize full load compressor and increase the fan speed to the rated airflow. When the temperature drops below the Y2 setpoint, the unit will return to part load and Balanced Climate fan speed. When the cooling call is satisfied, the compressor will shut down and the economizer will move to minimum position (ventilation setting) and the fan will continue to run at RATED airflow if A is energized on the low voltage terminal strip.

Call for cooling and ECONOMIZER IS AVAILABLE (due to outdoor conditions):

Two stage cooling thermostat is required and connector is disconnected at JADE controller to enable Balanced Climate mode (see Figure 7 on page 6).

Unit has a call for ventilation: Damper to Min position and fan will run at RATED airflow. Y1 energizes economizer and the Balance Climate fan speed simultaneously. If the temperature continues to rise, the Y2 terminal will energize part load compressor and increase the fan speed to the RATED airflow. When the temperature drops below the Y2 setpoint, the unit will return to part load and Balanced Climate fan speed. When the cooling call is satisfied, the compressor will shut down and the economizer will move to minimum position (ventilation setting) and the fan will increase to run at RATED airflow if A is energized on the low voltage terminal strip.

**TABLE 7
Unit Operation with S (Part Flow), Y and Z (Full Flow) Economizer Options
Single Stage Compressor Units (Balanced Climate Available)**

Unit Operation	Occ. Signal	Low Voltage 24VAC							Speed Taps			Fan Speed	Comp. Oper.	Damper
		G	Y1	Y2	W1	W2	A	D	1	2	3-4-5 ¹			
Fan Only	Yes	X					X		X			Vent	Off	Min Pos
Fan Only	No	X							X			Vent	Off	Closed
BC Cooling	Yes		X				X		X	X		B Climate	Econ	Min Pos
BC Cooling	No		X						X	X		B Climate	Econ	Closed
Full Load Cool	Yes		X	X			X		X	X	X	Lo/Med/Hi	On	Min Pos
Full Load Cool	No		X	X					X	X	X	Lo/Med/Hi	On	Closed
1st Stage Heat	Yes				X		X				X	Lo/Med/Hi	Off	Min Pos
1st Stage Heat	No				X						X	Lo/Med/Hi	Off	Closed
2nd Stage Heat	Yes				X	X	X				X	Lo/Med/Hi	Off	Min Pos
2nd Stage Heat	No				X	X					X	Lo/Med/Hi	Off	Closed
Dehumidify ²	Yes						X	X	X	X		B Climate	On	Min Pos
Dehumidify ²	No							X	X	X		B Climate	On	Closed

BC and B Climate – Balanced Climate

¹ Fan speed is selectable through the blower speed control terminal block. LO (default), MED or HI speeds can be used.

² Dehumidification operation is disabled when a call for heating or cooling occurs. Unit runs at Balanced Climate speed during dehumidification operation.

TABLE 8
Unit Operation with S (Part Flow), Y and Z (Full Flow) Economizer Options
2-Stage Compressor Units (Balanced Climate Unavailable)

Unit Operation	Occ. Signal	Low Voltage 24VAC								Speed Taps			Fan Speed	Comp. Oper.	Damper
		G	Y1	Y2	Y3	W1	W2	A	D	1	2	3-4-5 ¹			
Blower Only	Yes	X						X		X			Vent	Off	Min Pos
Blower Only	No	X								X			Vent	Off	Closed
Part Load Cool	Yes	X	X					X		X	X		Part Load	On	Min Pos
Part Load Cool	No	X	X							X	X		Part Load	On	Closed
Full Load Cool	Yes	X	X	X				X		X	X	X	Lo/Med/Hi	On	Min Pos
Full Load Cool	No	X	X	X						X	X	X	Lo/Med/Hi	On	Closed
1st Stage Heat	Yes					X		X				X	Lo/Med/Hi	Off	Min Pos
1st Stage Heat	No					X						X	Lo/Med/Hi	Off	Closed
2nd Stage Heat	Yes					X	X	X				X	Lo/Med/Hi	Off	Min Pos
2nd Stage Heat	No					X	X					X	Lo/Med/Hi	Off	Closed
Dehumidify ²	Yes							X	X	X	X		Part Load	On	Min Pos
Dehumidify ²	No								X	X	X		Part Load	On	Closed

¹ Fan speed is selectable through the blower speed control terminal block. LO (default), MED or HI speeds can be used.

² Dehumidification operation is disabled when a call for heating or cooling occurs. Unit runs at part load speed during dehumidification operation.

Single Stage Compressor Units – Economizer Operation – Balanced Climate Mode

Connector disconnected from **JADE** controller (see Figure 7 on page 6)

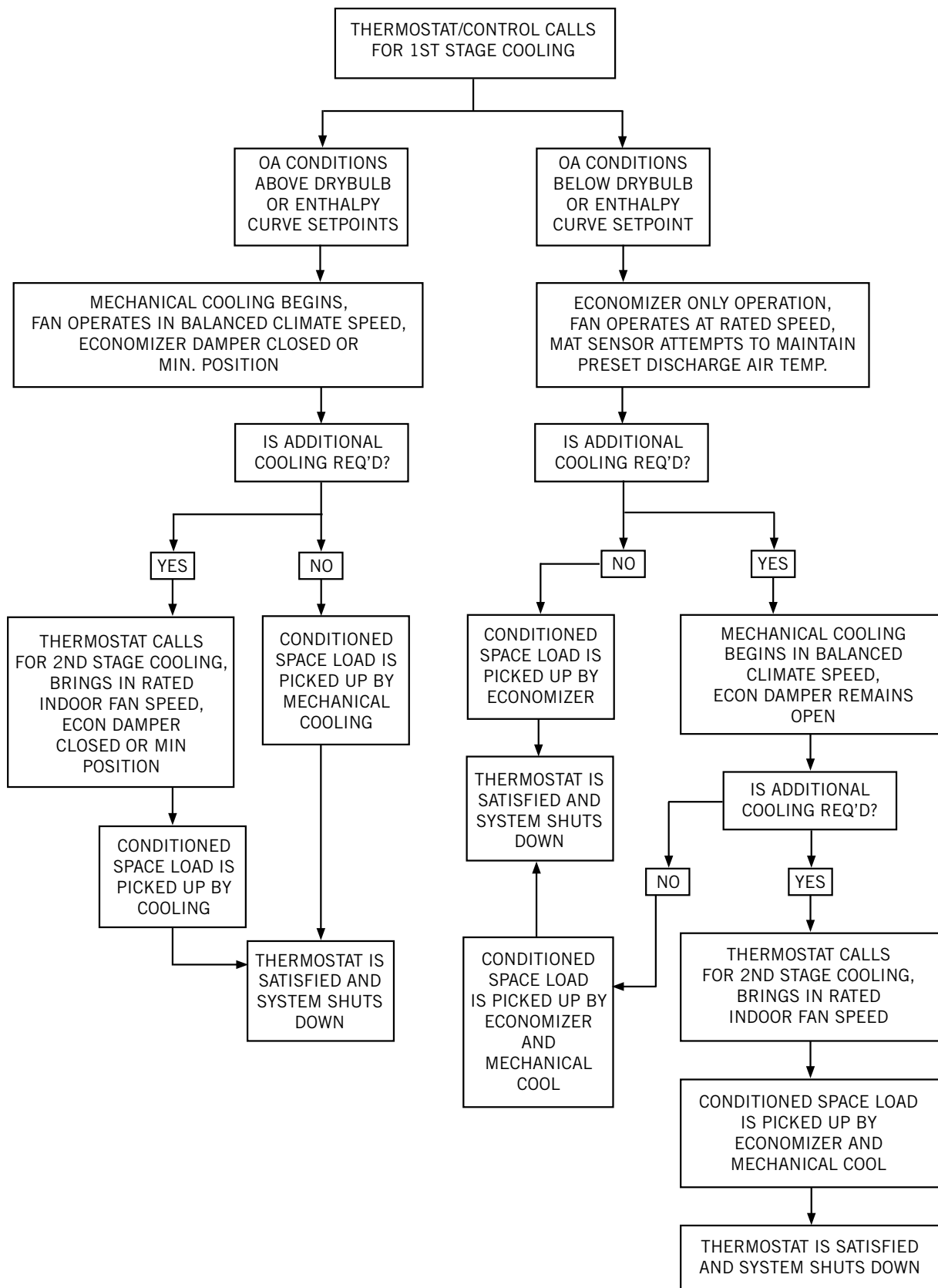

2-Stage Compressor Units – Economizer Operation – Part and Full Load Operation Balanced Climate Unavailable

Connector disconnected from JADE controller and reconnected to 2-stage compressor harness (see Figures 8 and 9 on page 7)

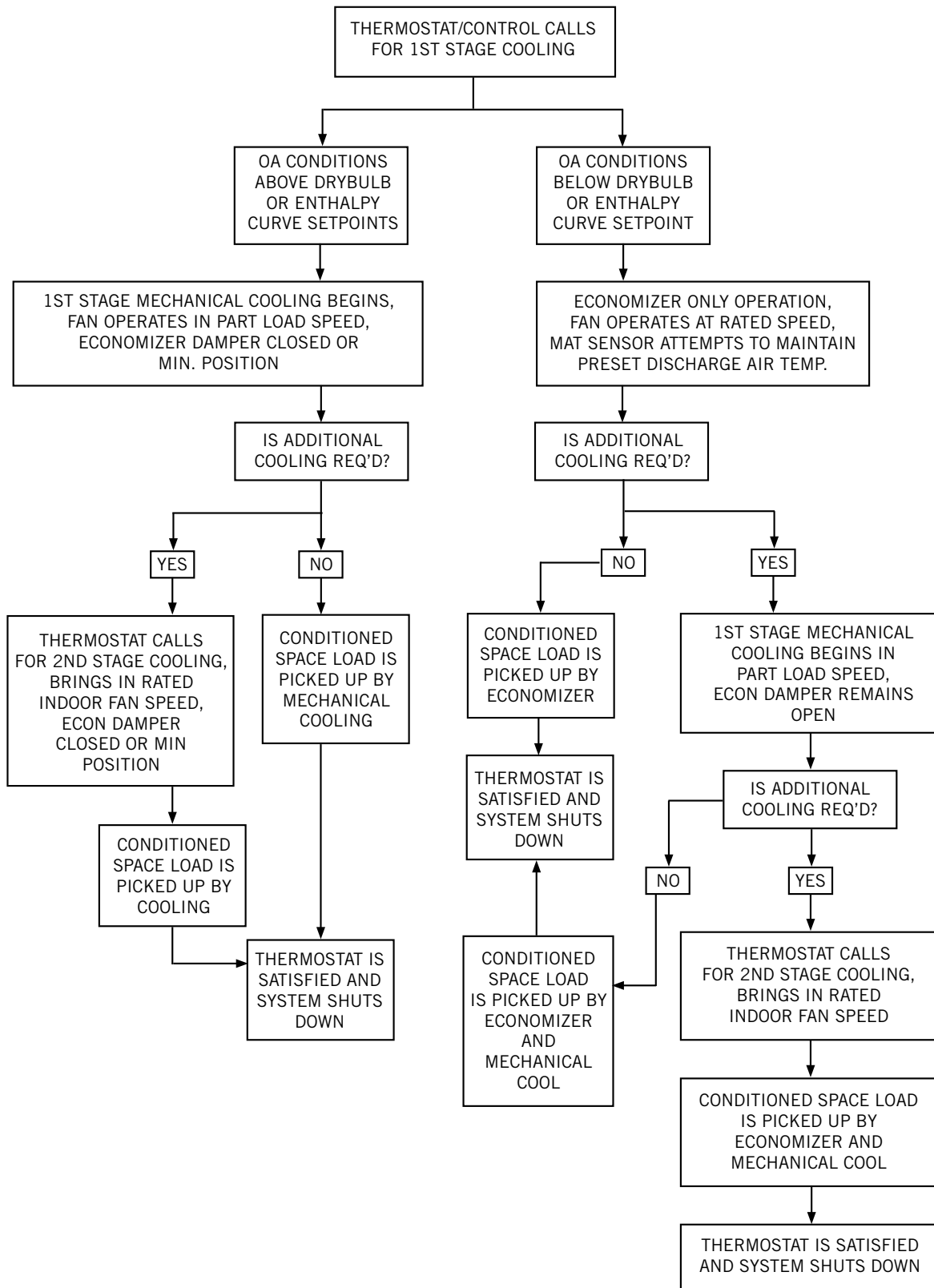
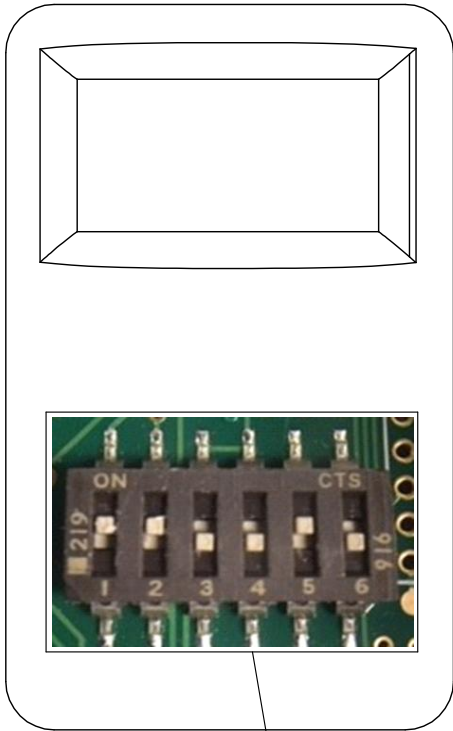
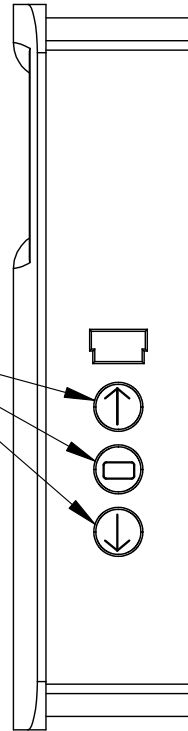

FIGURE 37
CO₂ Sensor Default and Final Settings
Bard Part #8403-096 CO₂ Controller



PRESS UP AND DOWN ARROWS TO ENTER CONFIGURATION MODE USE ARROWS TO SELECT SETTING. PUSH MIDDLE BUTTON TO CHANGE. CONTROLLER WILL SHOW SET.



NOTE: MENU DIP SWITCH MUST BE IN "ON" POSITION #5 TO CHANGE ANY SETTINGS WITH THE SIDE BUTTONS. TO LOCK THE CO2 CONTROLLER MOVE DIP SWITCH TO "OFF" AFTER IT HAS BEEN CONFIGURED.

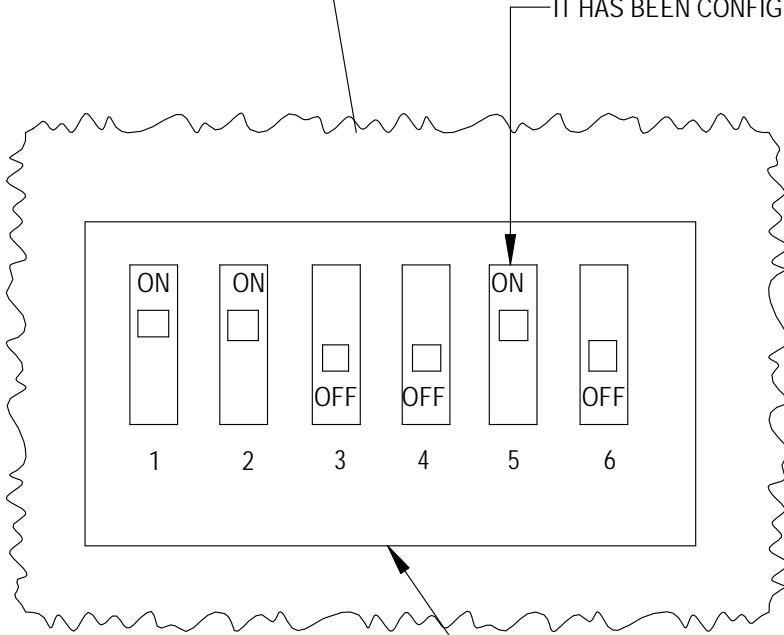

DIP SWITCHES MUST BE POSITIONED AS SHOWN FOR PROPER OPERATION

Settings	Recommended	Default
RON	Not Used	
ROF	Not Used	
DSP	C	CT
UNI	US	US
COL	700	0
COH	1500	2000
TOL	Not Used	
TOH	Not Used	
BAR	See Instrution with Controller For High Altitude Installations	
CAL	Used for Field Calibration	

MIS-4025 A

GRAPH 1
W3SAC ECON-WD/DB Ventilation Delivery

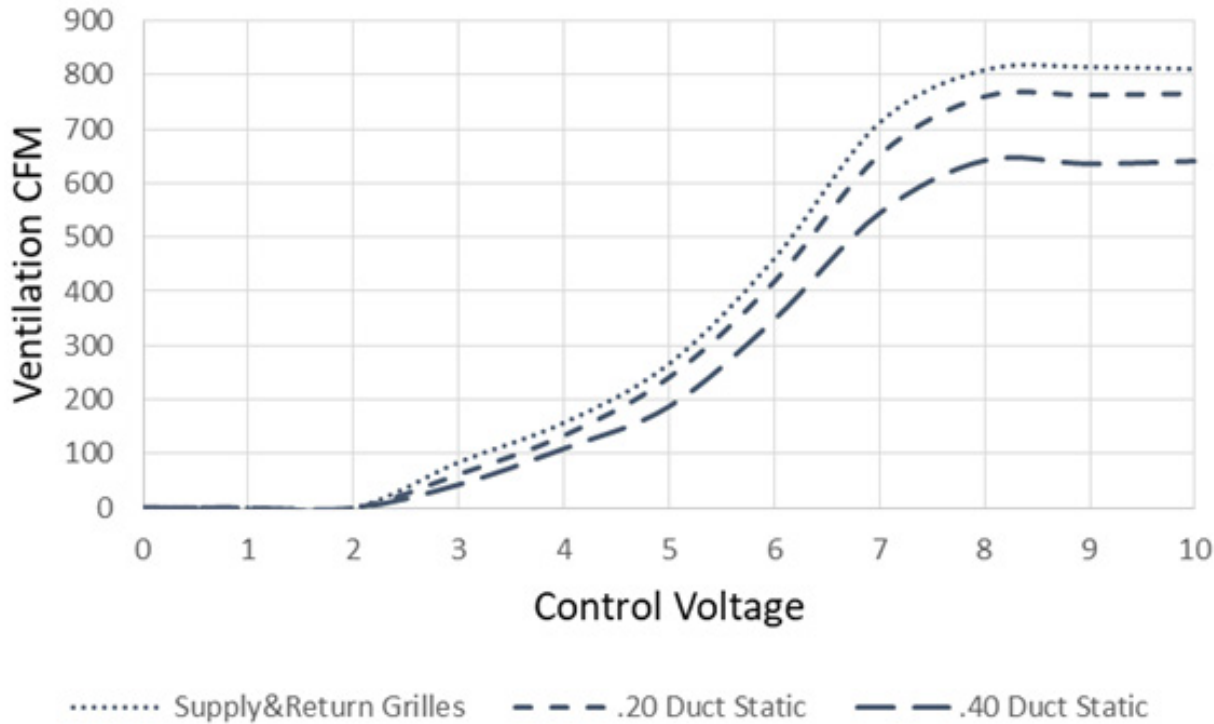

GRAPH 2
W/J42°C ECON-WD/DB Ventilation Delivery

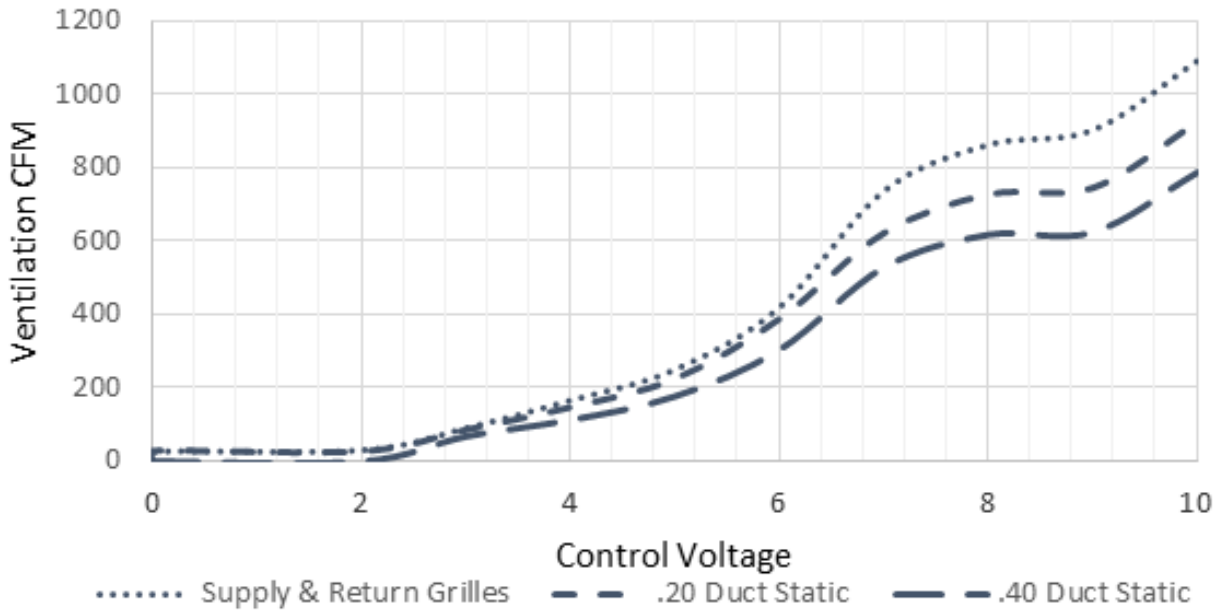

GRAPH 3
W4SAC & W/J48°C ECON-WD/DB Ventilation Delivery

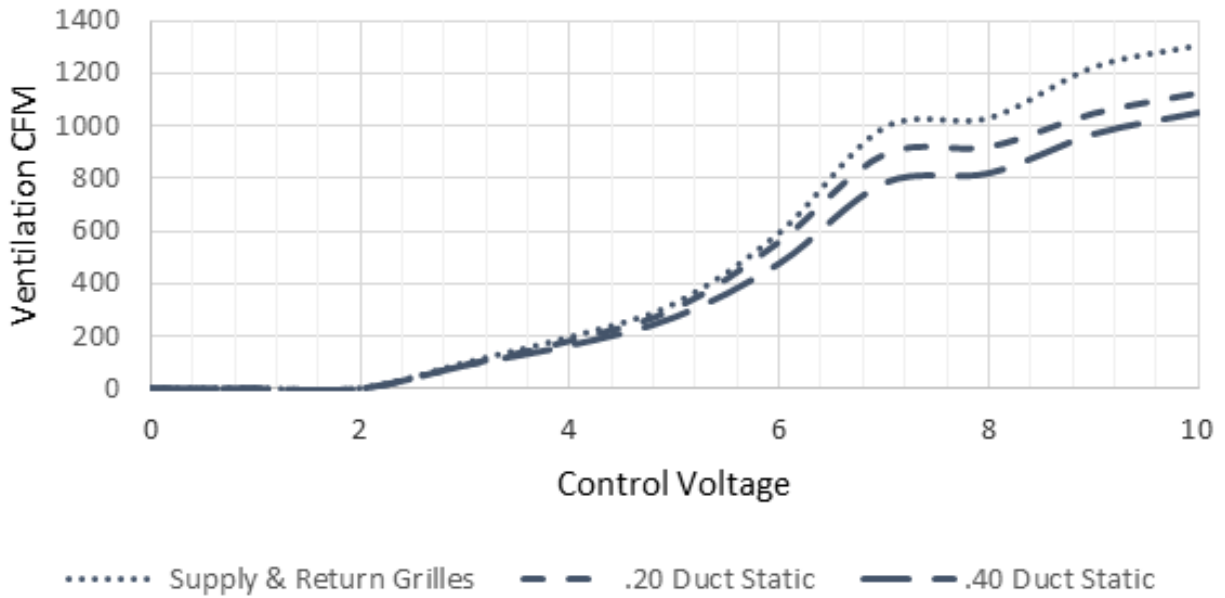

GRAPH 4
W5SAC & W/J60°C ECON-WD/DB Ventilation Delivery

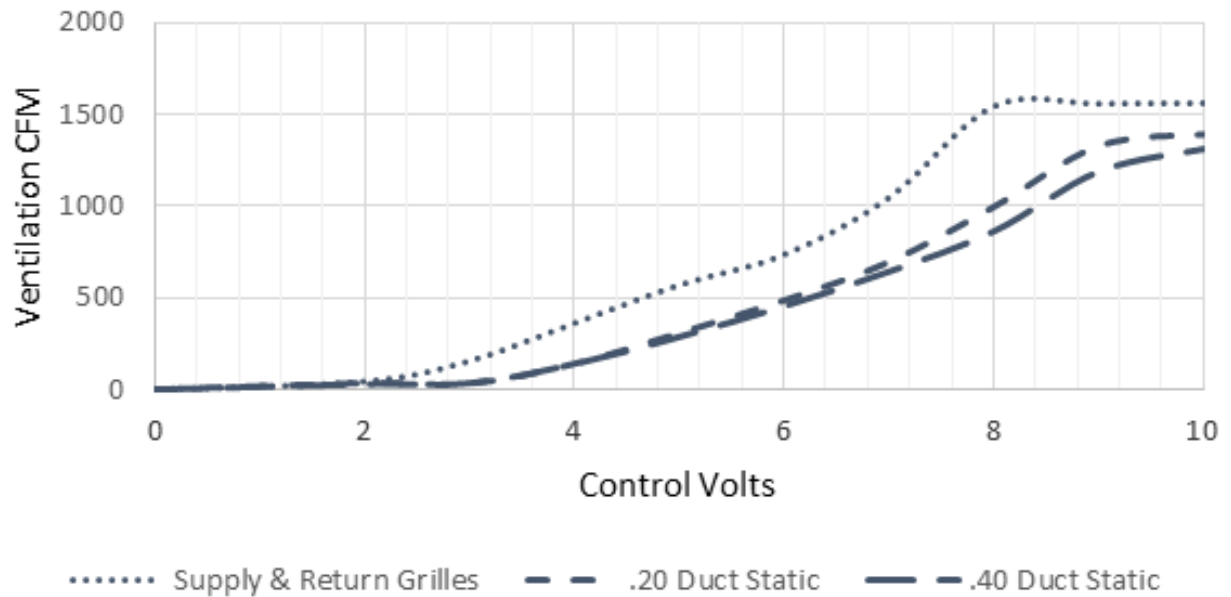

GRAPH 5
W/J72AC ECON-WD/DB Ventilation Delivery

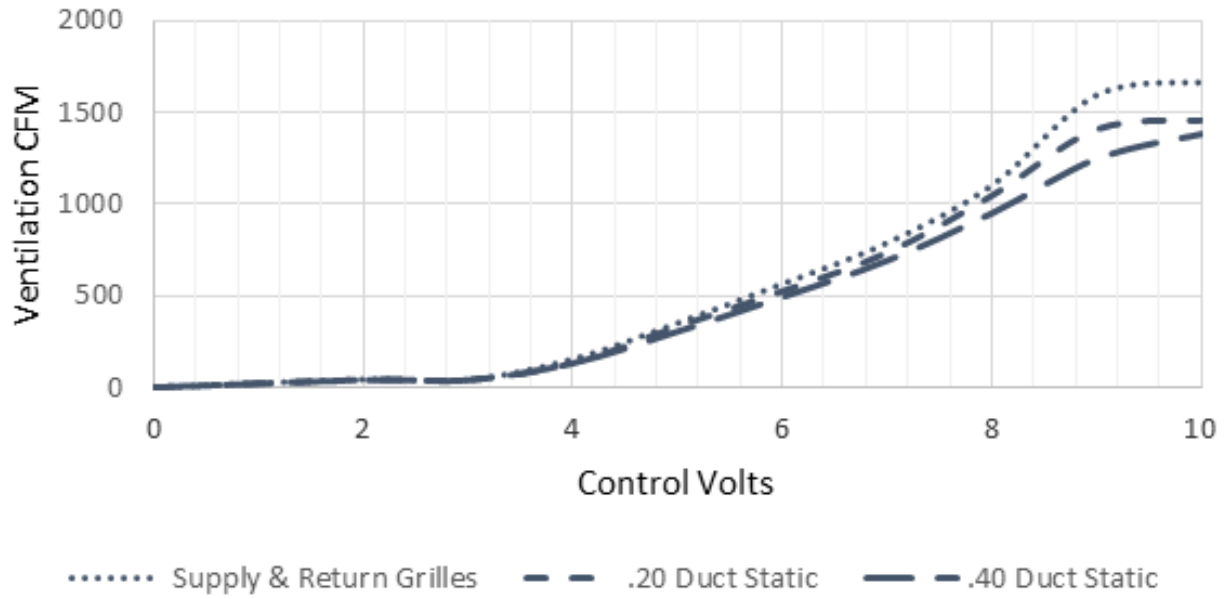
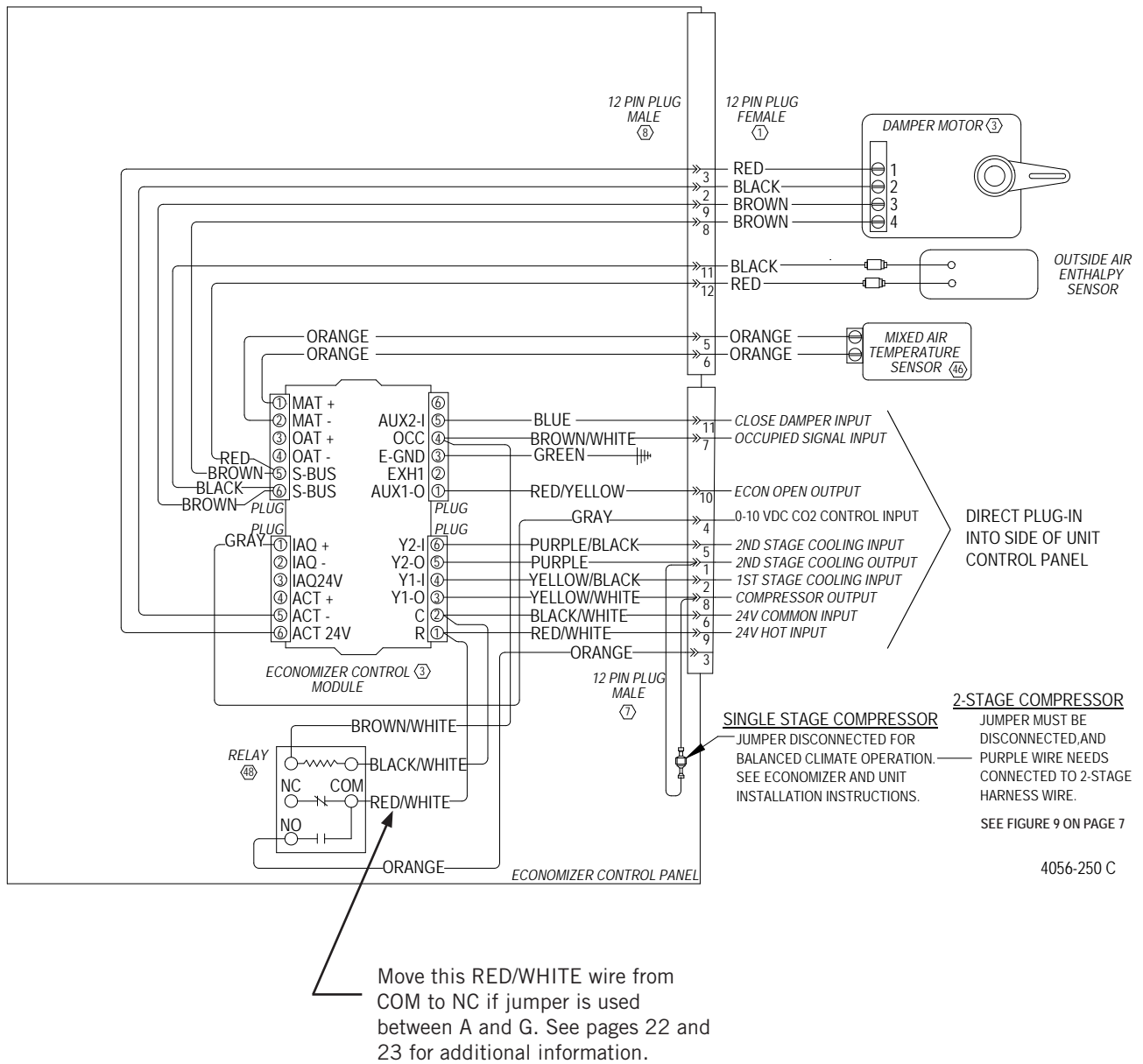
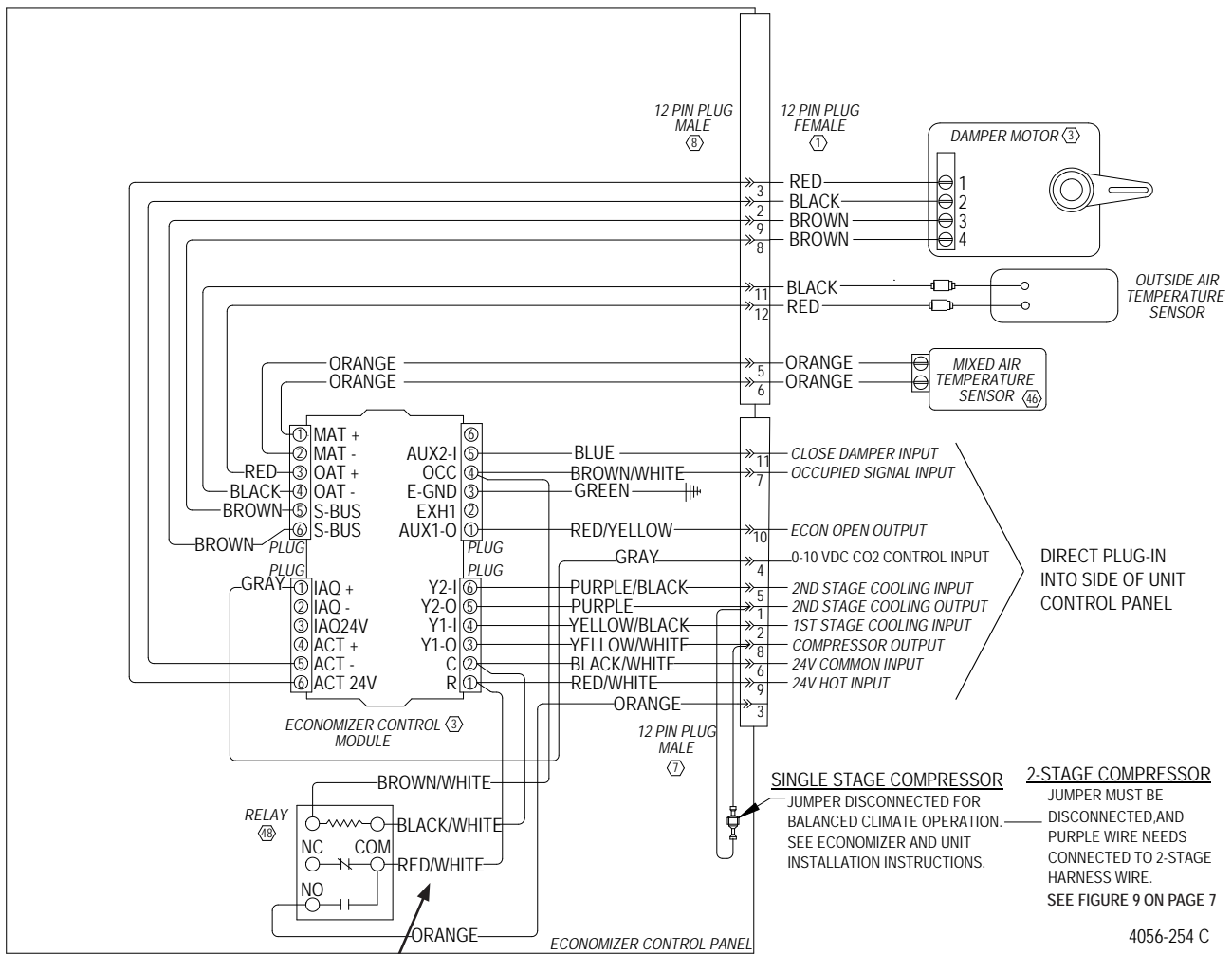

FIGURE 38
Wiring Diagram – Enthalpy Sensor



NOTE: The Y1-Y2 jumper must be removed from the unit low voltage terminal strip in order for the vent to function. This jumper is already removed in units with factory-installed economizers.

FIGURE 39
Wiring Diagram – Temperature Only Sensor



Move this RED/WHITE wire from COM to NC if jumper is used between A and G. See pages 22 and 23 for additional information.

NOTE: The Y1-Y2 jumper must be removed from the unit low voltage terminal strip in order for the vent to function. This jumper is already removed in units with factory-installed economizers.

FIGURE 40
Lubrication Points

