INSTALLATION INSTRUCTIONS

Full Flow Modulating Low Leakage Commercial Room Ventilator with Pre-Purge and Exhaust

Model: CRV-V5A



For Use with Bard Wall Mount
Air Conditioner and Heat Pump Models:

W3SAC, W4SAC, W5SAC
W42AC, W48AC, W60AC, W72AC
W42HC, W48HC, W60HC



Climate Control Solutions

Bard Manufacturing Company, Inc.
Bryan, Ohio 43506
www.bardhvac.com

Manual: 2100-754
Supersedes: **NEW**
Date: 3-11-21

CONTENTS

General Information3

Commercial Room Ventilator (CRV) Model Nomenclature	3
General Commercial Room Ventilator Information ...	3
Unpacking (Field Installation Only)	3
Kit Components (Field Installation Only).....	3
Service	4

Installation of Field-Installed CRV-V55

Basic Installation.....	5
CO ₂ Control.....	8
Control System Notes.....	9
Two Switch Application	9
Blade Adjustment for Desired Ventilation Air	10
Adjusting Blade Settings	10
Single Stage Compressor.....	10
2-Stage Compressor.....	10
"V" Option CRV Sequence of Operation	22
Pre-Purge Feature.....	22
Occupied Setting.....	22
Y1 Setting	22
Single Stage Compressor.....	22
2- Stage Compressor.....	22
Y2 Setting	22
Single Stage Compressor.....	22
2- Stage Compressor.....	23
2-10V Operation.....	23

FIGURES

Figure 1 Disconnect Power	5
Figure 2 Remove Side Grilles	5
Figure 3 Remove Blower Door and Control Panel ..	5
Figure 4 Remove Blank Off Plates (Both Sides)....	6
Figure 5 Remove Exhaust Blank Off Plate	6
Figure 6 Remove Air Filters and Low Voltage Control Panel Cover.....	6
Figure 7 Install 910-2065 Control Board Assembly	6
Figure 8 Install Vent.....	7
Figure 9 Control Plug Centered in Plug Access Opening.....	7
Figure 10 Connect CRV Power Plug to Control Panel Plug.....	7
Figure 11 Release the Exhaust Blade.....	7
Figure 12 Exhaust Blade and Latch	7
Figure 13 Install Intake Sealing Frame and Lower Block Off Plates	8
Figure 14 Install Mist Filters.....	8
Figure 15 Install Bug Screen and Gaskets	8
Figure 16 Ventilation Air Label	8
Figure 17 CRV Control Board Settings.....	9
Figure 18 CRV Control Board Wiring	11
Figure 19 Programmable Thermostat Connections for CRV with Single Stage Air Conditioners	12
Figure 20 Programmable Thermostat Connections for CRV with 2-Stage Air Conditioners ..	13

Figure 21 Programmable Thermostat Connections for CRV with Heat Pumps.....	14
Figure 22 Non-Programmable Thermostat Connections for CRV with Single Stage Air Conditioners	15
Figure 23 Non-Programmable Thermostat Connections for CRV with 2-Stage Air Conditioners	16
Figure 24 Non-Programmable Thermostat Connections for CRV with Heat Pumps..	17
Figure 25 CO ₂ Sensor Default and Final Settings Bard Part #8403-096 CO ₂ Controller ...	18
Figure 26 CRV Control Board	22
Figure 27 Call for Ventilation With or Without Compressor Operation	25
Figure 28 Call for Compressor or Fan Only with Ventilation Off	25
Figure 29 Lubrication Points.....	26

GRAPHS

Graph 1 W3SAC CRV-V5 Ventilation Delivery	19
Graph 2 W42°C CRV-V5 Ventilation Delivery	19
Graph 3 W48°C and W4SAC CRV-V5 Ventilation Delivery.....	20
Graph 4 W60°C and W5SAC CRV-V5 Ventilation Delivery.....	20
Graph 5 W72AC CRV-V5 Ventilation Delivery	21

TABLES

Table 1 Unit Operation with V (Variable CRV) Ventilation Option for Single Stage Compressor Units	23
Table 2 Unit Operation with V (Variable CRV) Ventilation Option for 2-Stage Compressor Units	24

Commercial Room Ventilator (CRV) Model Nomenclature

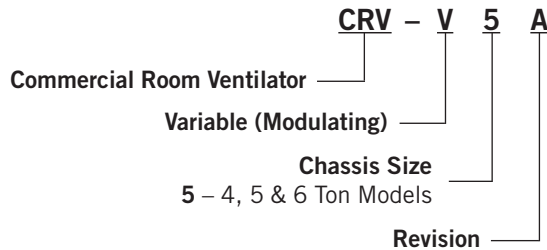

General Commercial Room Ventilator Information

Commercial room ventilator use provides a way to bring in outdoor air into a structure. The damper assembly allows outdoor ventilation air to enter both sides of the wall mount unit, while exhausting room air out the front of the unit above the condenser coil area. A 24VAC damper motor with linkage operates both the exhaust blade and both intake blades. The indoor blower operates while ventilation occurs. A control board allows for various ventilation options. The following benefits can be attributed to CRV use:

- Air is drawn through the sides of the unit using the indoor blower and enters the indoor area through the supply opening.
- Pressurized room air enters the unit return opening and is exhausted through the front of the unit.
- Ventilation can be controlled as an on/off 24VAC signal or a 0-10VDC modulating signal to the CRV control board.

The CRV control board provides inputs for multiple blade positions for use with wall mount units with multiple indoor airflow amounts like the WSAC product. A pre-purge ventilation setting is also available with a 30/60/90 minute timer to allow ventilation to start per a schedule at a specified CFM amount. To use the pre-purge feature, scheduled ventilation would be started before occupants enter the room. A 0-10VDC input allows for modulating control of the ventilation amount. The 0-10VDC signal can be provided by a DDC building management system or a CO₂ sensor with modulating control. If additional room pressurization is required, it may be necessary to block off part or all of the room exhaust.

The CRV system consists of the following key features and components:

- Openings on both sides of the unit that allow outdoor air to enter the wall mount unit. A filter covers the opening to reduce debris and moisture entry into the unit. Once the air enters the unit, it

is drawn through the filter located above the vent area and transferred into the building by the indoor blower.

- An opening in the front of the unit that allows pressurized indoor air to leave the building. A corrosion-resistant screen covers the opening.
- Three blades located inside the CRV assembly that control the amount of air entering and leaving the building.
- A fully modulating spring return damper motor with a control arm, connecting rods and blade linkage that operates the CRV blades.
- A solid-state control board that operates the damper motor.

Overall, this manual is designed to explain how to field install the CRV, how the CRV functions and discuss CRV setup procedures. If this manual is being supplied with a wall mount unit that already has a factory installed CRV, it may not be necessary to review the field installation portion of this manual.

Unpacking (Field Installation Only)

Upon receipt of the equipment be sure to compare the model number found on the shipping label with the accessory identification information on the ordering and shipping document to verify that the correct accessory has been shipped.

Inspect the carton housing of each ventilator as it is received, and before signing the freight bill, verify that all items have been received and that there is no visible damage (check parts list below). Note any shortages or damage on all copies of the freight bill. The receiving party must contact the last carrier immediately, preferably in writing, requesting inspection by the carrier's agent. Concealed damage not discovered until after loading must be reported to the carrier within 15 days of its receipt.

Kit Components (Field Installation Only)

The ventilator should only be installed by a trained heating and air conditioning technician. These instructions serve as a guide to the technician installing the ventilator package. They are not intended as a step-by-step procedure with which the mechanically inclined owner can install the package.

The ventilator housing is shipped in one carton which contains the electrical harness, miscellaneous hardware and installation instructions.

Ventilator kit includes:

- CRV-V5 ventilator
- 7003-084 mist filter (2)
- 7003-083 exhaust bug screen
- 1913-002-0808 8-1/2" foam strip (2)
- 1913-002-0708 7-1/2" foam strip (4)
- 539-405 intake sealing frame (2)
- 910-2065 control board assembly
- 543-223 lower block off plate (2)
- #10-16x1/2 screw (12)
- #8-18x3/8 pan head screw (4)
- 2100-754 installation instructions

Service

The low leakage ventilators/economizers use stainless steel intake blade seals. It is recommended that the side seals, ball joints, and blade hinges be lubricated with a graphite dry lubricant once a year or during filter changes (see Figure 29 on page 26).

INSTALLATION OF FIELD-INSTALLED CRV-V5

Basic Installation

WARNING

Electrical shock hazard.
Disconnect remote electrical power supply or supplies before servicing.
Failure to do so could result in electric shock or death.

WARNING

Exposed moving parts.
Disconnect electrical power before servicing.
Failure to do so could result in severe injury or amputation.

CAUTION

Cut hazard.
Wear gloves to avoid contact with sharp edges.
Failure to do so could result in personal injury.

Disconnect all power to unit (see Figure 1).

FIGURE 1
Disconnect Power



Remove both side grilles (see Figure 2).

FIGURE 2
Remove Side Grilles

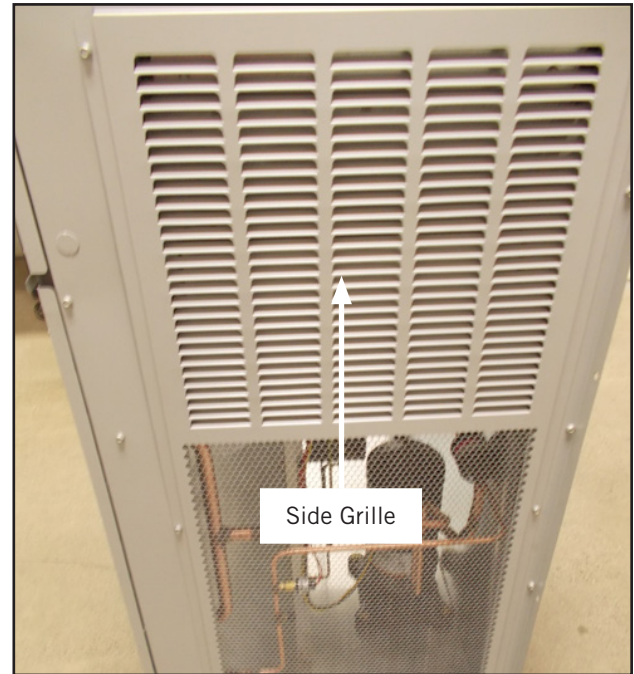

Remove upper blower door and outer control panel (see Figure 3).

FIGURE 3
Remove Blower Door and Control Panel

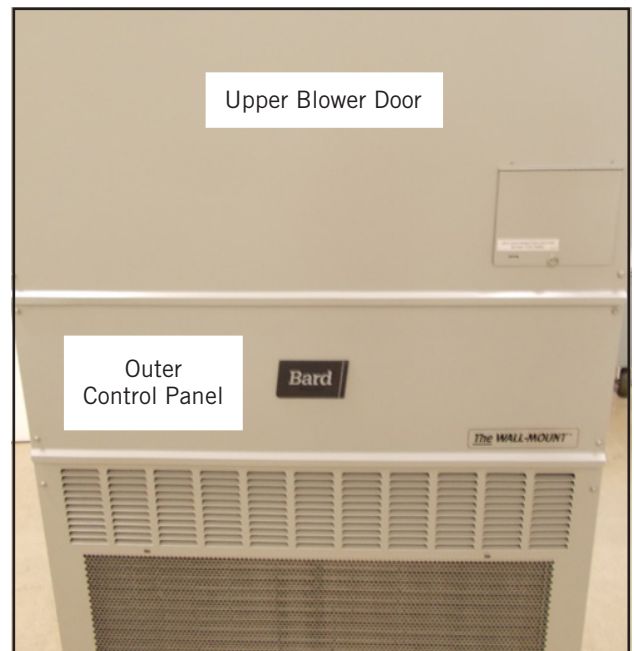

Remove blank off plates (both sides) and discard (see Figure 4).

FIGURE 4
Remove Blank Off Plates (Both Sides)



Remove exhaust blank off plate through return or through side intake openings and discard (see Figure 5).

FIGURE 5
Remove Exhaust Blank Off Plate

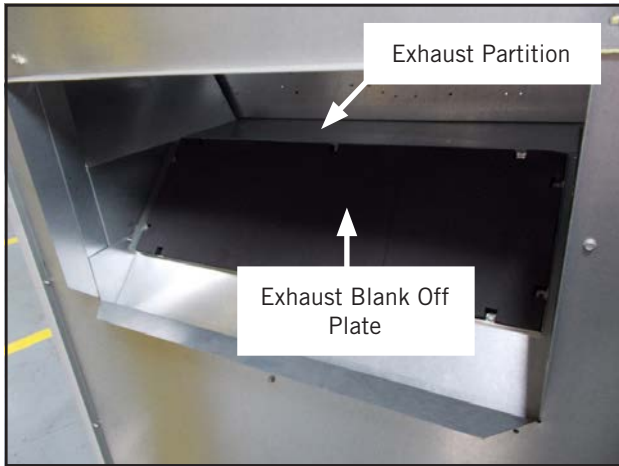

Remove both air filters and the low voltage inner control panel cover (see Figure 6). Remove left filter first then slide right filter to the left to remove.

FIGURE 6
Remove Air Filters and Low Voltage Control Panel Cover

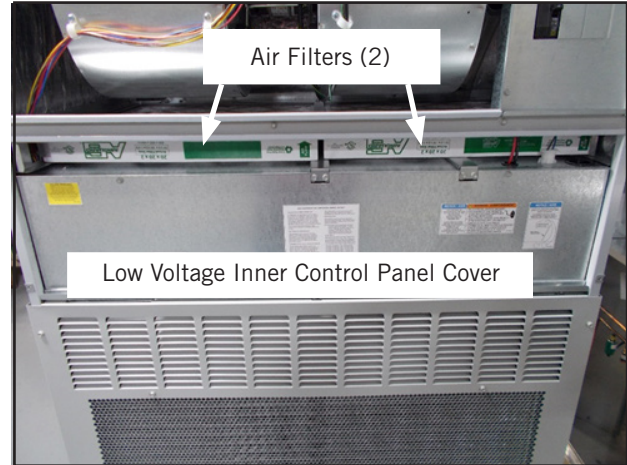

Install the 910-2065 control board assembly on the left side of the control panel using four (4) #10 x 1/2 screws (provided) as shown in Figure 7.

Snap the four pin connector into the opening next to the low voltage box.

Plug the 12 pin male connector into the female plug in the low voltage box.

FIGURE 7
Install 910-2065 Control Board Assembly

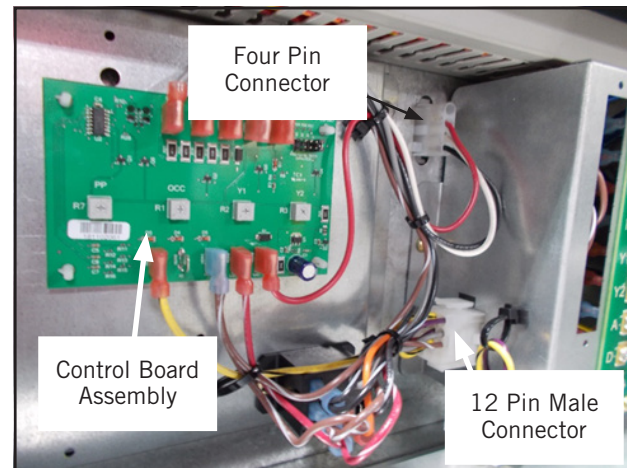

Before installing vent, remove CRV from packaging and verify there is no damage. Install the CRV as shown in Figure 8. CRV can be installed from either side.

Set CRV on the exhaust partition (see Figure 5 on page 5) and slide in until flush with the side of the wall mount.

FIGURE 8
Install Vent



When the CRV is fully installed, the control plug should be centered in the plug access opening on the front panel of the CRV as shown in Figure 9.

FIGURE 9
Control Plug Centered in Plug Access Opening

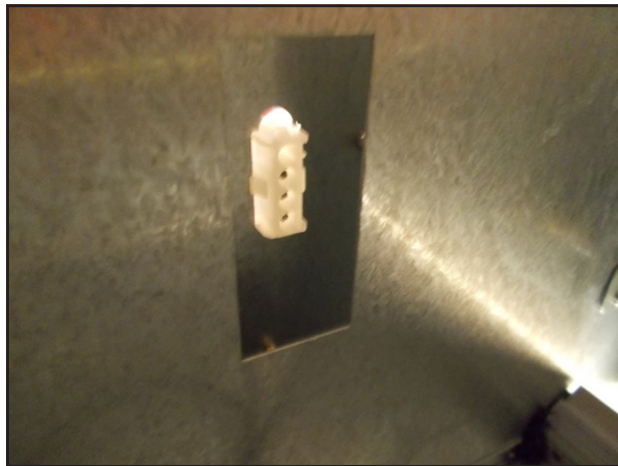

From the front, through the filter opening, plug the CRV power plug into the control panel plug (see Figure 10).

IMPORTANT: Sharp edges--PPE required.

FIGURE 10
Connect CRV Power Plug to Control Panel Plug

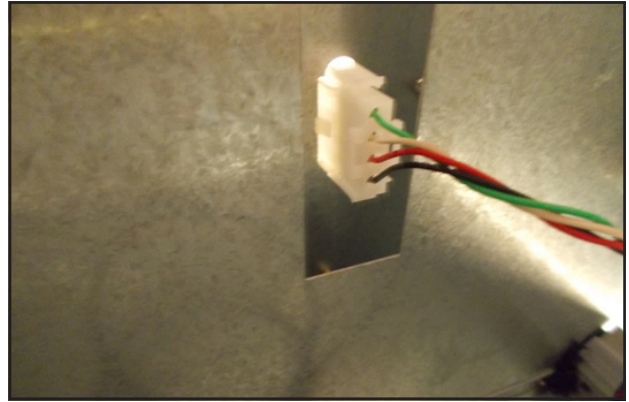

The CRV exhaust blade is fixed in the shipping position by the latch located on the bottom of the blade (see Figure 11). Access can be made through the return air opening or through the opening under the CRV. Turning the latch 1/4 turn will release the blade.

FIGURE 11
Release the Exhaust Blade



Make sure the blade seats correctly over the exhaust opening and that the latch is as shown in Figure 12.

FIGURE 12
Exhaust Blade and Latch



Install the 539-405 intake sealing frame and the 543-223 lower block off plates (both sides) as shown in Figure 13. Install two (2) 1913-002-0708 7-1/2" foam gaskets below the intake sealing frame (both sides).

FIGURE 13
Install Intake Sealing Frame and Lower Block Off Plates

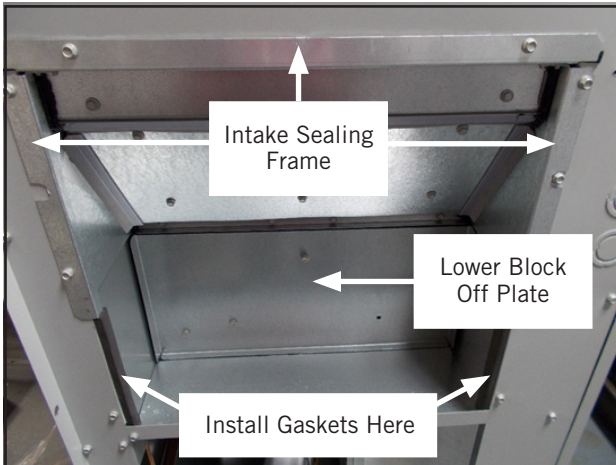

Bend the two (2) sheet metal tabs in the condenser partition up to hold the bottom of the mist eliminator in place.

Install 7003-084 mist filters on both sides (see Figure 14). Then re-install the side grilles removed earlier.

FIGURE 14
Install Mist Filters



Remove the front lower (condenser) grille and bend the two (2) sheet metal tabs in the condenser partition up to hold the bottom of the bug screen in place. Install two (2) 1913-002-0808 8-1/2" foam gaskets to ends of cabinet (see Figure 15). Install the 7003-083 exhaust bug screen. Re-install grille.

FIGURE 15
Install Bug Screen and Gaskets

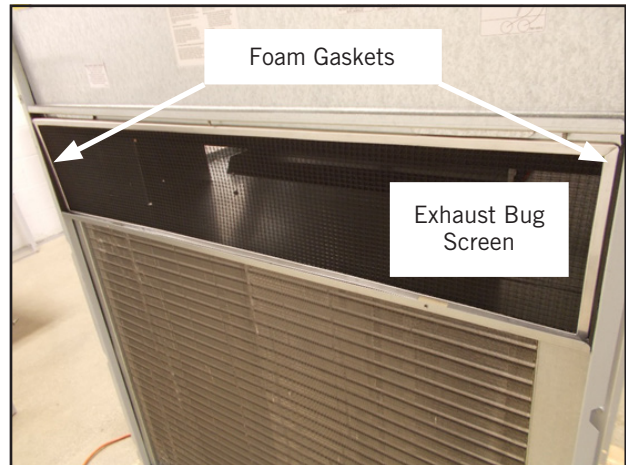

Restore power to unit.

Set the preferred amount of ventilation air by using the numbered label on the CRV (see Figure 16) and referring to **Blade Adjustment for Desired Ventilator Air** on page 10 and the airflow charts on pages 19, 20 and 21.

FIGURE 16
Ventilation Air Label

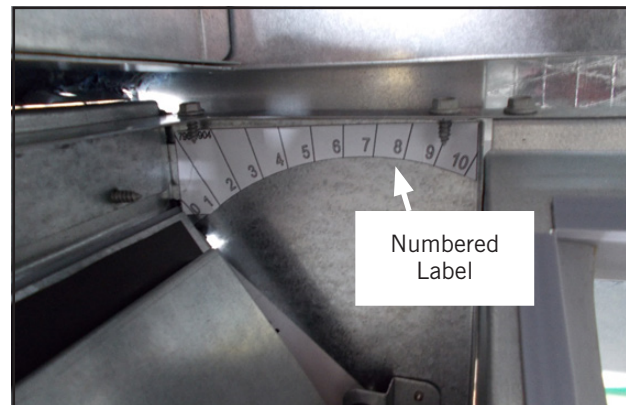

When blade settings are complete, disconnect power.

Install both filters, then re-install the inner control panel, outer control panel and upper blower door.

Restore power to unit.

CO₂ Control

For CO₂-based control, add CO₂ sensor/controller (Bard part #8403-096) to the wall and run additional optional wires as shown in the wiring diagrams on pages 12-17.

The CO₂ controller must also be reconfigured from the standard default settings as shipped from the factory. See page 18 for complete details.

Control System Notes

This ventilation package is capable of being set to meet the current ASHRAE specifications for minimum occupied airflow rates, with extended capability to meet demand ventilation requirements.

Two Switch Application

Energizing the A terminal in the low voltage connection box during occupied conditions will allow the prepurge and minimum occupied airflow rates to be set to meet ASHRAE requirements. This can be accomplished by adjusting the PP and OCC potentiometers on the CRV control board (see Figure 17) by aligning the damper position per the charts included on pages 19, 20 and 21.

FIGURE 17
CRV Control Board Settings

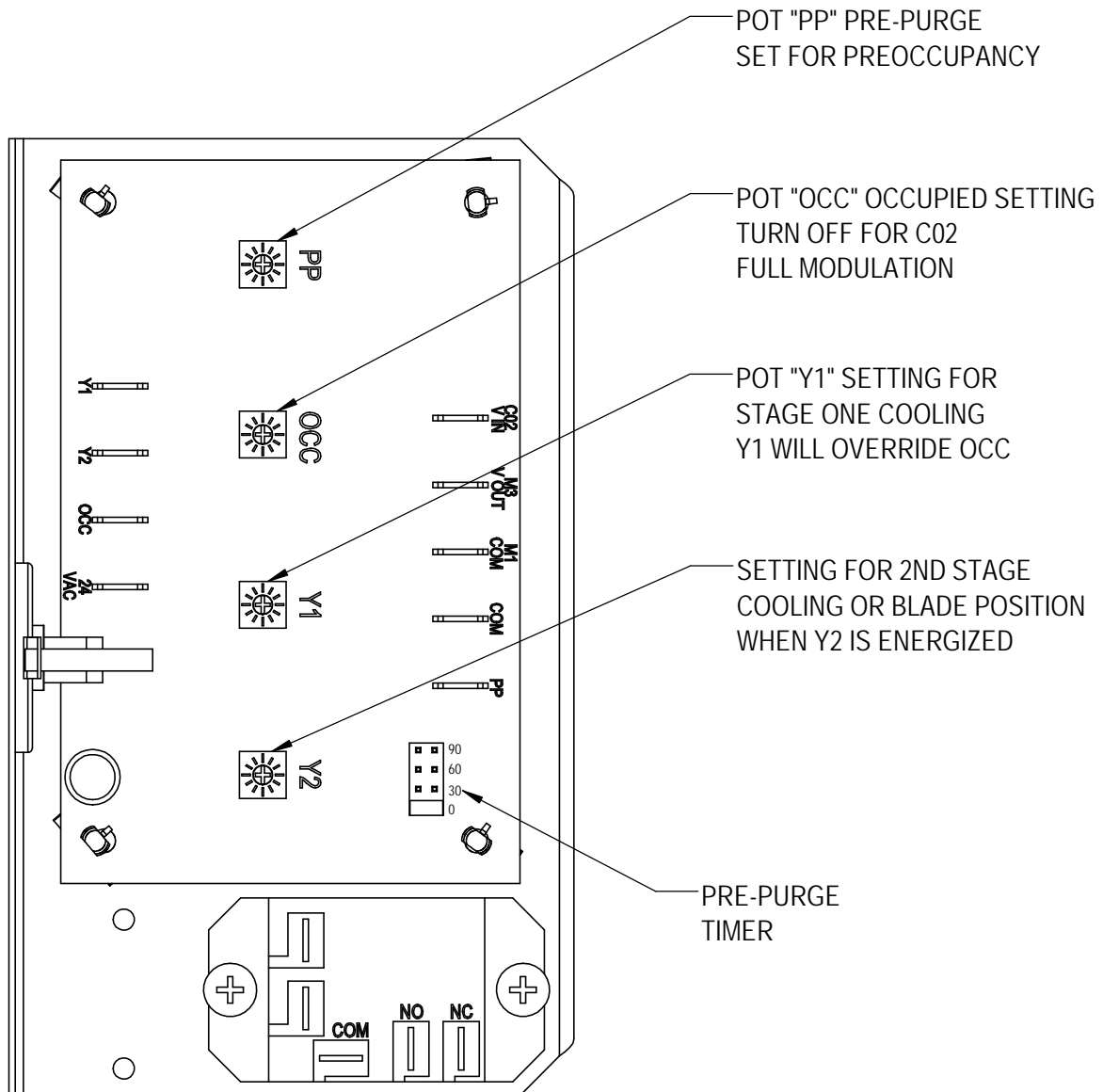

MIS-4047

Blade Adjustment for Desired Ventilator Air

The amount of ventilation air supplied by the commercial room ventilator is dependant on four factors.

1. Return air duct static pressure drop.
2. Supply air duct static pressure drop.
3. Indoor blower motor speed.
4. Damper blade open position setting.

Refer to the appropriate graph on pages 19, 20 and 21 to determine the blade setting necessary to achieve the ventilation air required for each operating mode.

All potentiometers are set in the closed position from the factory.

Turning potentiometers counter clockwise will close the blade; clockwise will open the blade.

Adjusting Blade Settings

Single Stage Compressor

Blade settings can be made without the thermostat connected.

1. With the unit powered up, jumper R to A. The OCC potentiometer on the CRV board can be set. Remove jumper.
2. Move the pre-purge jumper on the board to the 30 second setting, then jumper R to A and set the PP potentiometer.
3. Remove jumper from R to A, then move pre-purge jumper back to 0.
4. Remove the factory jumper on unit low voltage terminal strip from Y1 and Y2.
5. Jumper R to A and Y1 and set the Y1 potentiometer; this will be used for Balanced Climate mode. Set blade to achieve 28% more airflow than indicated on graph when using Balanced Climate mode.
6. With factory jumper still removed from Y1 and Y2, jumper R to A, Y1 and Y2. The Y2 potentiometer can now be set. This setting will be activated when the factory jumper is installed and there is a call for cooling or anytime Y2 is energized.

2-Stage Compressor

Blade settings can be made without the thermostat connected.

1. With the unit powered up, jumper R to A. The OCC potentiometer on the CRV board can be set.
2. Move the pre-purge jumper on the board to the 30 second setting, then jumper R to A and set the PP potentiometer.
3. Remove jumper from R to A, then move pre-purge jumper back to 0.

4. Jumper R to A and Y1 and set the Y1 potentiometer; this will be used for part load mode and Balanced Climate mode when the Y2 and Y3 jumper is removed. Set blade to achieve 28% more airflow than indicated on graph when using part load cooling and Balanced Climate mode.
5. Jumper R to A, Y1, Y2 and Y3. The Y2 potentiometer can now be set. This setting will be activated when the factory jumper is installed and there is a call for full load cooling or anytime Y3 is energized.

FIGURE 18
CRV Control Board Wiring

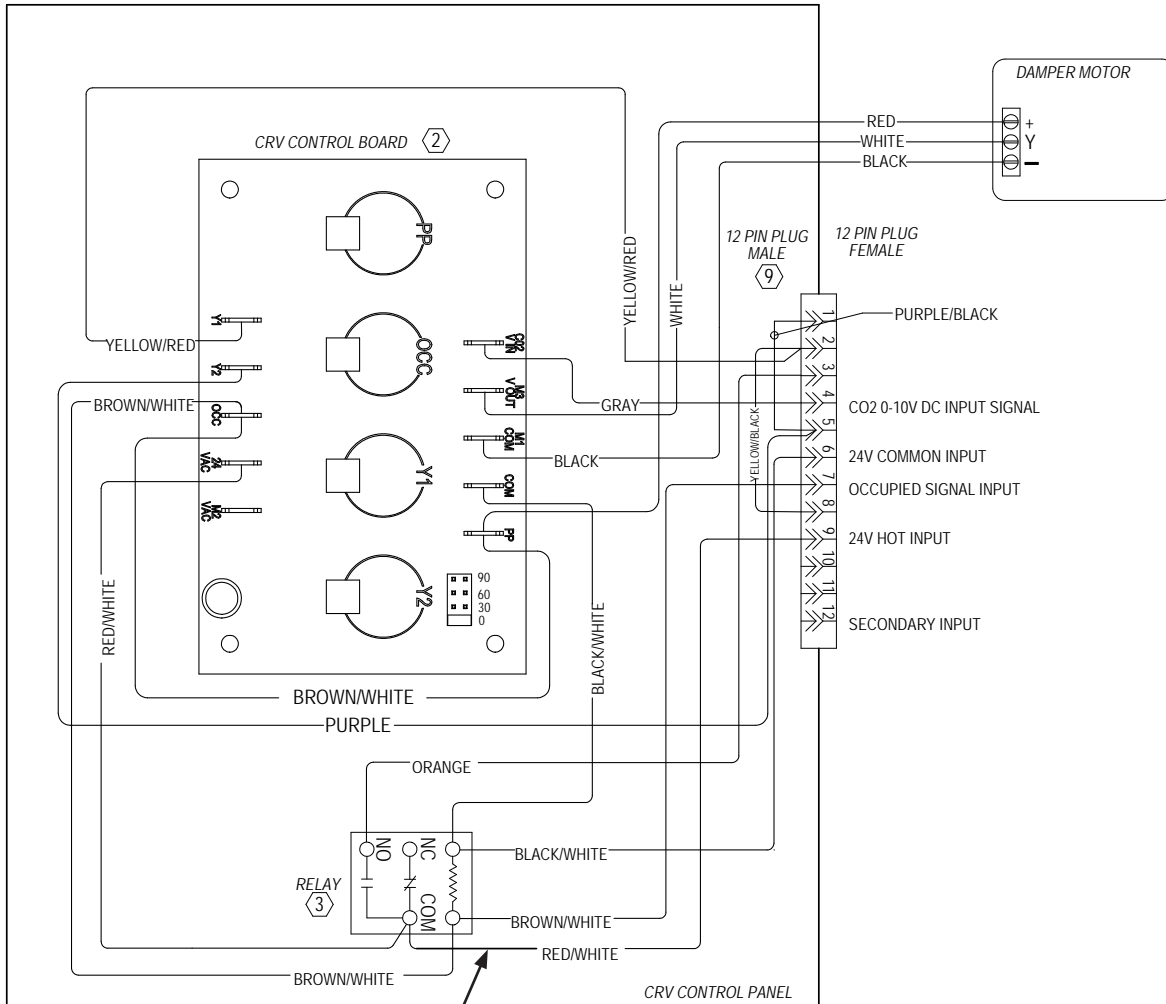

4056-241 A

Move this RED/WHITE wire from COM to NC if jumper is used between A and G. See pages 15, 16 or 17 for additional information.

FIGURE 19
Programmable Thermostat Connections for CRV with Single Stage Air Conditioners

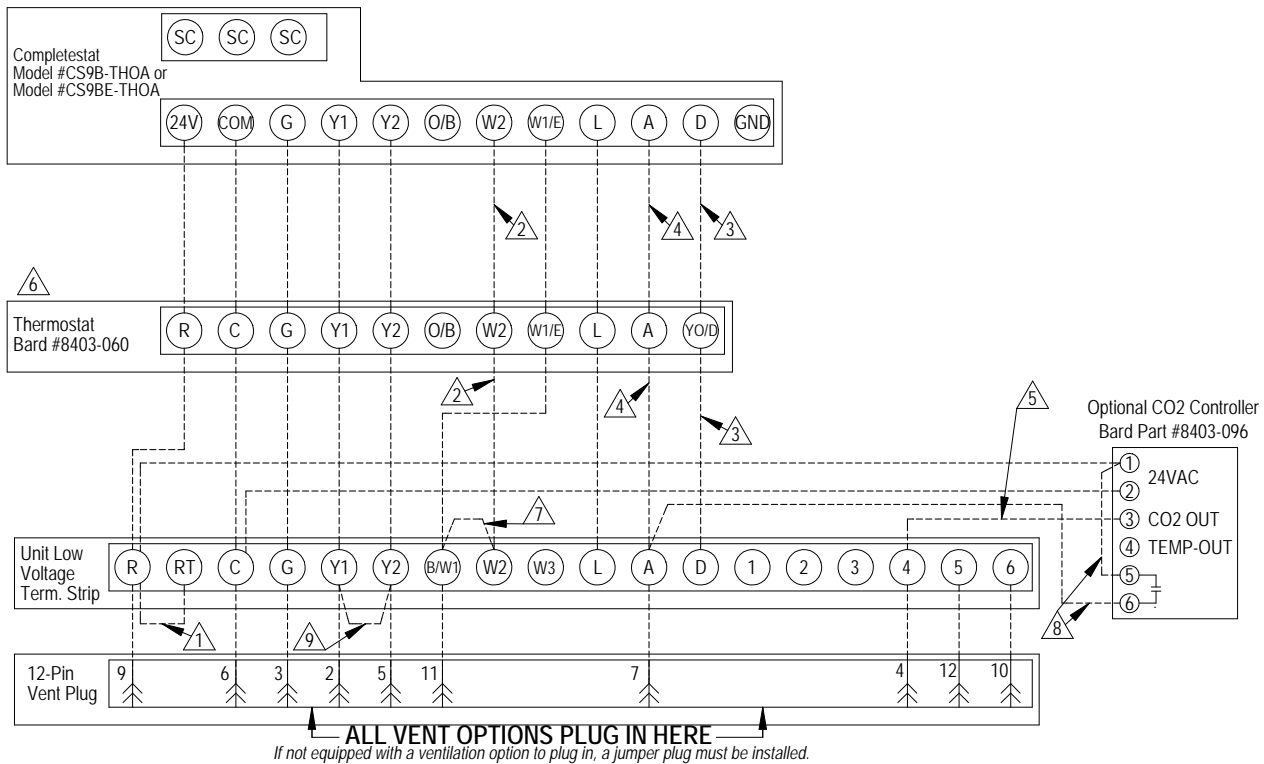

- △1 Factory installed jumper. Remove jumper and connect to N.C fire alarm circuit if emergency shutdown required.
- △2 Wire not needed below 15KW.
- △3 Wire required for dehumidification models only.
- △4 Do not connect "A" from thermostat if optional CO2 controller is used
- △5 0-10 VDC modulating CO2 control signal for modulating ventilation control (optional for ECON only - see vent instruction manuals)
- △6 Change model configuration from heat pump to heat/cool. Must be configured to programmable and fan set to be programmed fan for the "A" output to function during scheduled occupied periods. Must be configured for multi-stage for Y1 output to be active 1st stage cooling. For dehumidification, must be configured for "No Economizer" for YO/D to be active for humidity control.
- △7 Install jumper for 1 stage electric heat on units with less than 15KW
- △8 Do not add these wires if setting up for modulating control. See note 5.
- △9 Factory installed jumper. Remove jumper to activate Balanced Climate™ mode. A 2-stage thermostat is recommended for Balanced Climate mode.

MIS-3974 C

FIGURE 20
Programmable Thermostat Connections for CRV with 2-Stage Air Conditioners

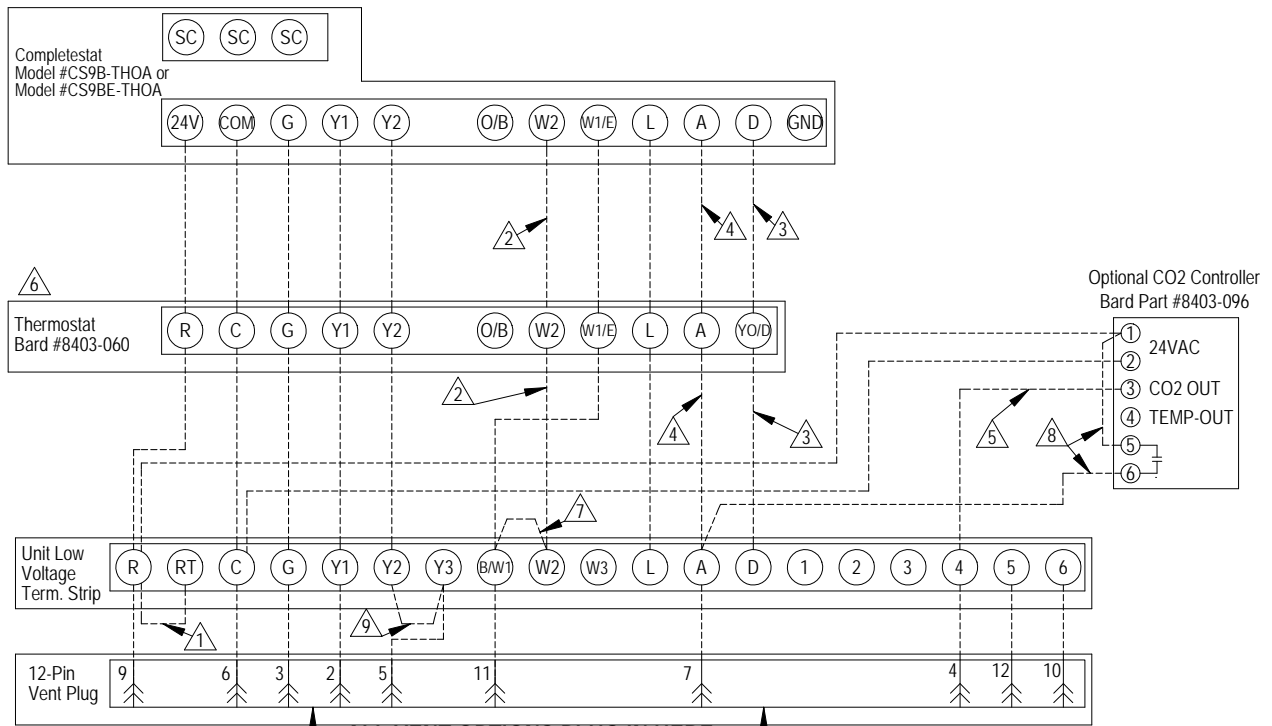

ALL VENT OPTIONS PLUG IN HERE
If not equipped with a ventilation option to plug in, a jumper plug must be installed.

- △1 Factory installed jumper. Remove jumper and connect to N.C fire alarm circuit if emergency shutdown required.
- △2 Wire not needed below 15KW.
- △3 Wire required for dehumidification models only.
- △4 Do not connect "A" from thermostat if optional CO2 controller is used
- △5 0-10 VDC modulating CO2 control signal for modulating ventilation control (optional for ECON only - see vent instruction manuals)
- △6 Change model configuration from heat pump to heat/cool. Must be configured to programmable and fan set to be programmed fan for the "A" output to function during scheduled occupied periods. Must be configured for multi-stage for Y1 output to be active 1st stage cooling. For dehumidification, must be configured for "No Economizer" for YO/D to be active for humidity control.
- △7 Install jumper for 1 stage electric heat on units with less than 15KW
- △8 Do not add these wires if setting up for modulating control. See note 5.
- △9 Factory installed jumper. Remove jumper to activate Balanced Climate™ mode A 3 stage thermostat is recommended for Balance Climate Mode.

MIS-4293

FIGURE 21
Programmable Thermostat Connections for CRV with Heat Pumps

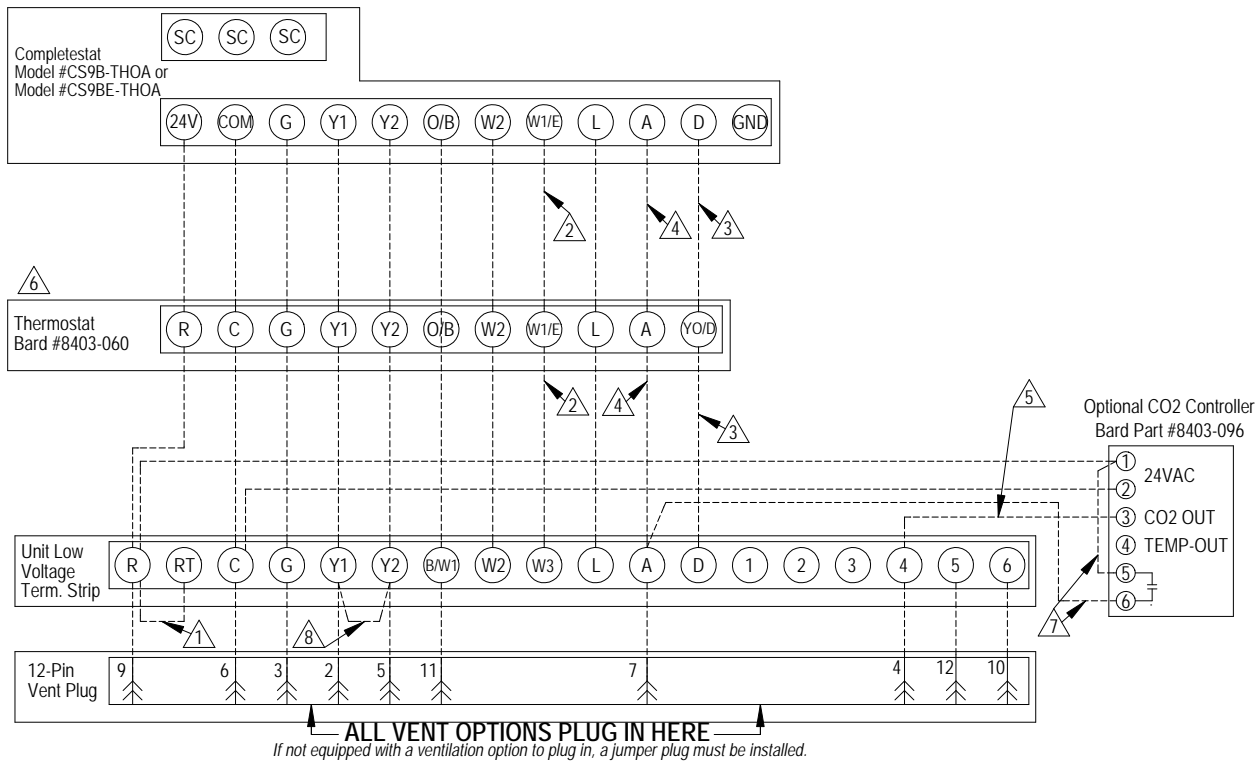

- | | |
|---|---|
| <p>⚠️ 1 Factory installed jumper. Remove jumper and connect to N.C fire alarm circuit if emergency shutdown required.</p> <p>⚠️ 2 Wire not needed below 15KW.</p> <p>⚠️ 3 Wire required for dehumidification models only.</p> <p>⚠️ 4 Do not connect "A" from thermostat if optional CO2 controller is used</p> <p>⚠️ 5 0-10 VDC modulating CO2 control signal for modulating ventilation control (optional for ECON only - see vent instruction manuals)</p> | <p>⚠️ 6 Ensure model configuration is heat pump and not heat/cool. Must be configured to programmable and fan set to be programmed fan for the "A" output to function during scheduled occupied periods. Must be configured for multi-stage for Y1 output to be active 1st stage cooling. For dehumidification, must be configured for "No Economizer" for YO/D to be active for humidity control.</p> <p>⚠️ 7 Do not add these wires if setting up for modulating control.</p> <p>⚠️ 8 Factory installed jumper. Jumper is not installed on unit with economizers. Jumper is located in jade wiring harness.</p> |
|---|---|

MIS-4063 D

FIGURE 22
Non-Programmable Thermostat Connections for CRV with Single Stage Air Conditioners

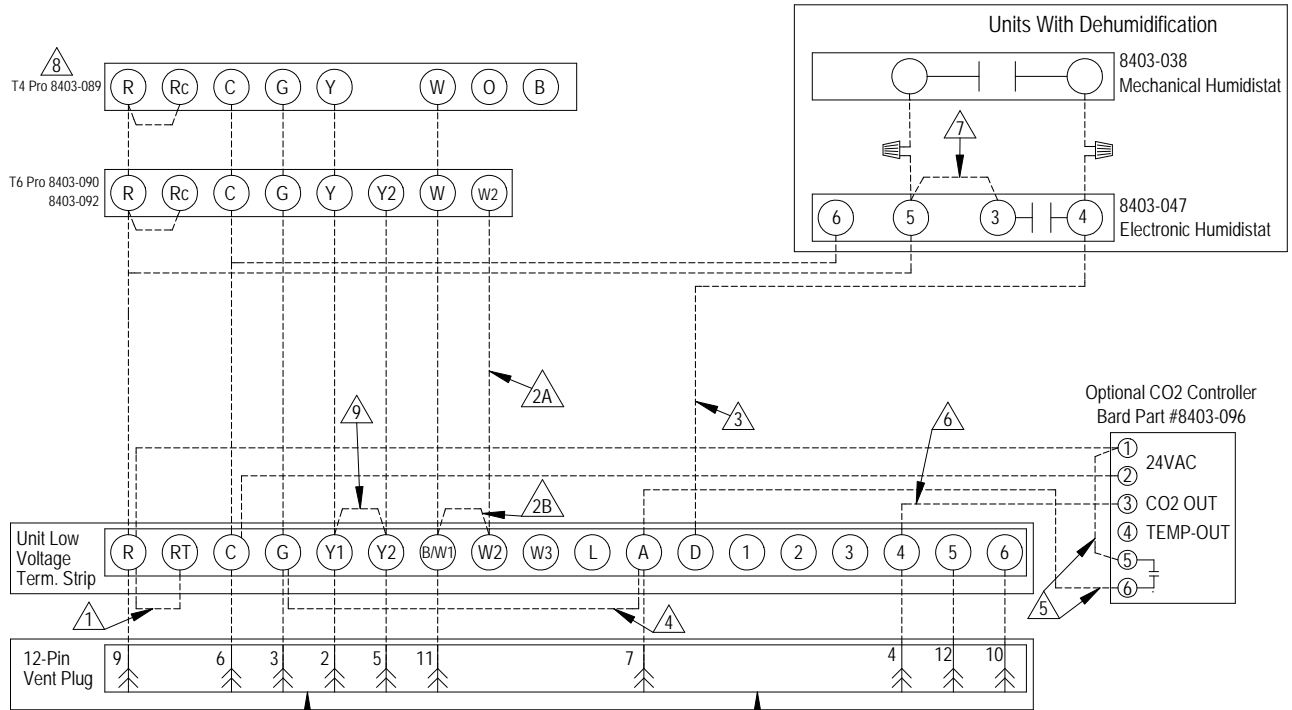

ALL VENT OPTIONS PLUG IN HERE

If not equipped with a ventilation option to plug in, a jumper plug must be installed.

- ① Factory installed jumper. Remove jumper and connect to N.C fire alarm circuit if emergency shutdown required.
- ②A Wire not needed below 15KW.
- ②B Install Jumper for 1 stage electric heat on units with more than 10KW.
- ③ Wire required for dehumidification models only.
- ④ For vent operation, add jumper if optional CO2 controller is not used. Vent will run while blower is energized. For ECON & CRV-V an additional wire change is required. See install Manual.
- ⑤ Do not add these wires if setting up for modulating control. See note 6.
- ⑥ 0-10 VDC Modulating CO2 control signal for modulating ventilation control (Optional for ECON Only) - See vent installation manual.
- ⑦ Jumper needs added.
- ⑧ Thermostat will not work with units equipped with economizers.
- ⑨ Factory installed jumper. Remove jumper to activate Balanced Climate™ Mode. A 2-stage thermostat is recommended for Balanced Climate mode.

MIS-3975 D

IMPORTANT NOTE

An additional wire change is required if jumper ④ is used which connects "A" to "G" (shown on Figures 22, 23 and 24). The red/white wire on the blower interlock relay (located on the vent control plate) needs to be moved from the "common" terminal to the "normally closed" terminal. **If this change is not made, the relay will latch on once the "A" signal is received and the blower will not turn off.** Refer to page 11 to see the wiring diagram with this change called out.

FIGURE 23
Non-Programmable Thermostat Connections for CRV with 2-Stage Air Conditioners

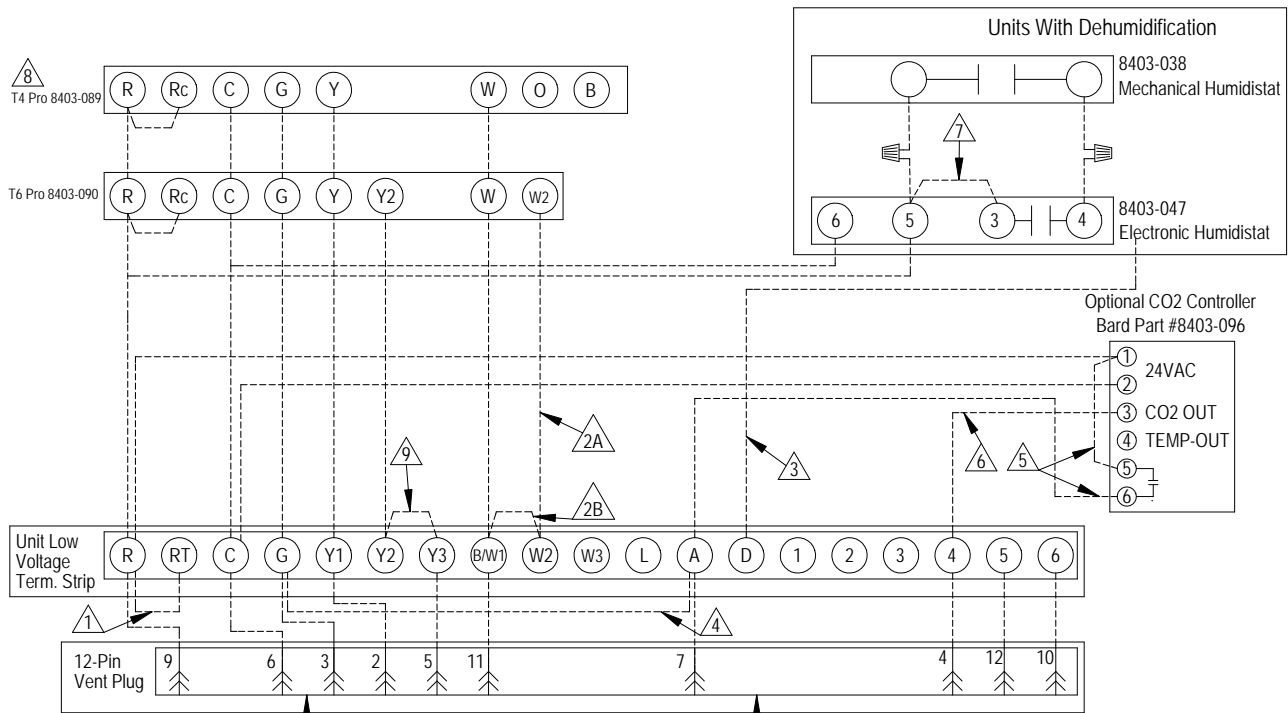

ALL VENT OPTIONS PLUG IN HERE

If not equipped with a ventilation option to plug in, a jumper plug must be installed.

- | | |
|---|--|
| <p>1 Factory installed jumper. Remove jumper and connect to N.C fire alarm circuit if emergency shutdown required.</p> <p>2A Wire not needed below 15KW.</p> <p>2B Install Jumper for 1 stage electric heat on units with more than 10KW.</p> <p>3 Wire required for dehumidification models only.</p> <p>4 For vent operation, add jumper if optional CO2 controller is not used. Vent will run while blower is energized. For ECON & CRV-V an additional wire change is required. See install Manual.</p> <p>5 Do not add these wires if setting up for modulating control. See note 6.</p> | <p>6 0-10 VDC Modulating CO2 control signal for modulating ventilation control (Optional for ECON Only) - See vent installation manual.</p> <p>7 Jumper needs added.</p> <p>8 Thermostat will not work with units equipped with economizers.</p> <p>9 Factory installed jumper. Remove jumper to activate Balanced Climate™ Mode. A 3-stage thermostat is recommended for Balanced Climate mode.</p> |
|---|--|

MIS-4294

IMPORTANT NOTE

An additional wire change is required if jumper 4 is used which connects "A" to "G" (shown on Figures 22, 23 and 24). The red/white wire on the blower interlock relay (located on the vent control plate) needs to be moved from the "common" terminal to the "normally closed" terminal. **If this change is not made, the relay will latch on once the "A" signal is received and the blower will not turn off.** Refer to page 11 to see the wiring diagram with this change called out.

FIGURE 24
Non-Programmable Thermostat Connections for CRV with Heat Pumps

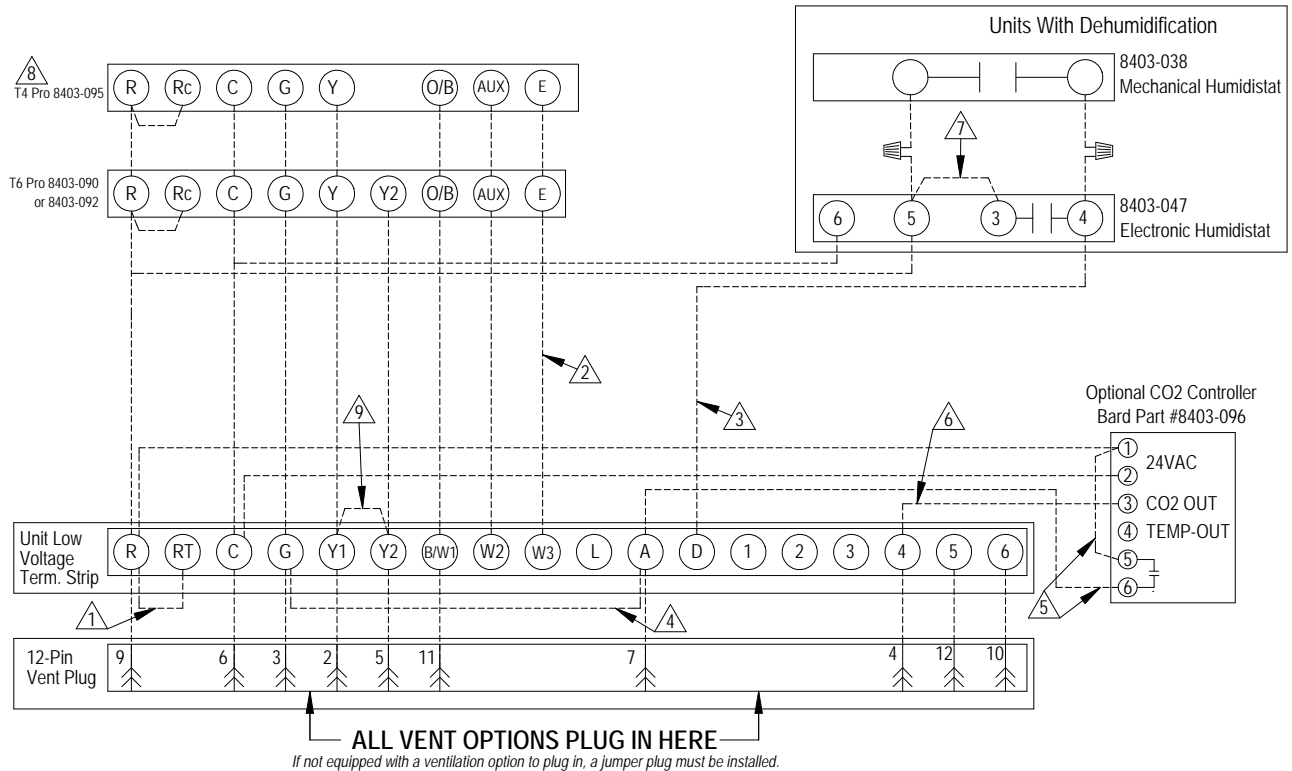

ALL VENT OPTIONS PLUG IN HERE
 If not equipped with a ventilation option to plug in, a jumper plug must be installed.

- 1 Factory installed jumper. Remove jumper and connect to N.C fire alarm circuit if emergency shutdown required.
- 2 Wire not needed below 15KW.
- 3 Wire required for dehumidification models only.
- 4 For vent operation, add jumper if optional CO2 controller is not used. Vent will run while blower is energized. For ECON & CRV-V, an additional wire change is required. See install manual.
- 5 Do not add these wires if setting up for modulating control. See note 6.
- 6 0-10 VDC Modulating CO2 control signal for modulating ventilation control (Optional for ECON Only) - See vent installation manual.
- 7 Jumper needs added.
- 8 Thermostat will not work with units equipped with economizers.
- 9 Factory installed jumper. Remove jumper to activate Balanced Climate™ Mode. A 2-stage thermostat is recommended for Balanced Climate mode.

MIS-4064 E

IMPORTANT NOTE

An additional wire change is required if jumper 4 is used which connects "A" to "G" (shown on Figures 22, 23 and 24). The red/white wire on the blower interlock relay (located on the vent control plate) needs to be moved from the "common" terminal to the "normally closed" terminal. **If this change is not made, the relay will latch on once the "A" signal is received and the blower will not turn off.** Refer to page 11 to see the wiring diagram with this change called out.

FIGURE 25
CO₂ Sensor Default and Final Settings
Bard Part #8403-096 CO₂ Controller

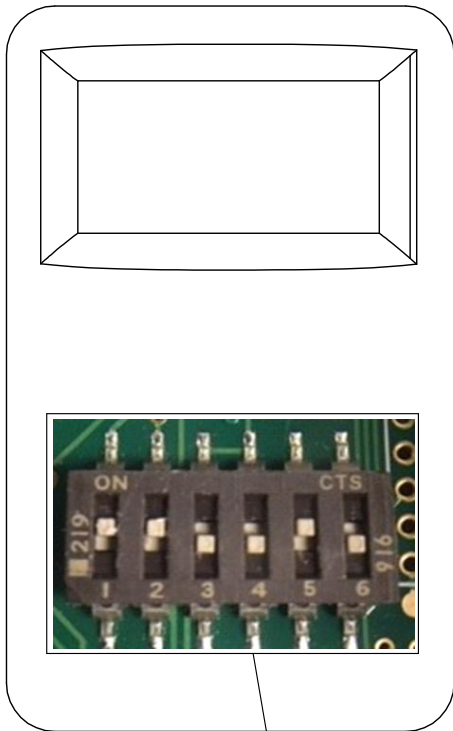

PRESS UP AND DOWN
 ARROWS TO ENTER
 CONFIGURATION MODE
 USE ARROWS TO SELECT
 SETTING. PUSH MIDDLE
 BUTTON TO CHANGE.
 CONTROLLER WILL
 SHOW SET.

NOTE: MENU
 DIP SWITCH MUST
 BE IN "ON" POSITION #5
 TO CHANGE ANY
 SETTINGS WITH
 THE SIDE BUTTONS.
 TO LOCK THE CO₂
 CONTROLLER MOVE
 DIP SWITCH TO "OFF" AFTER
 IT HAS BEEN CONFIGURED.

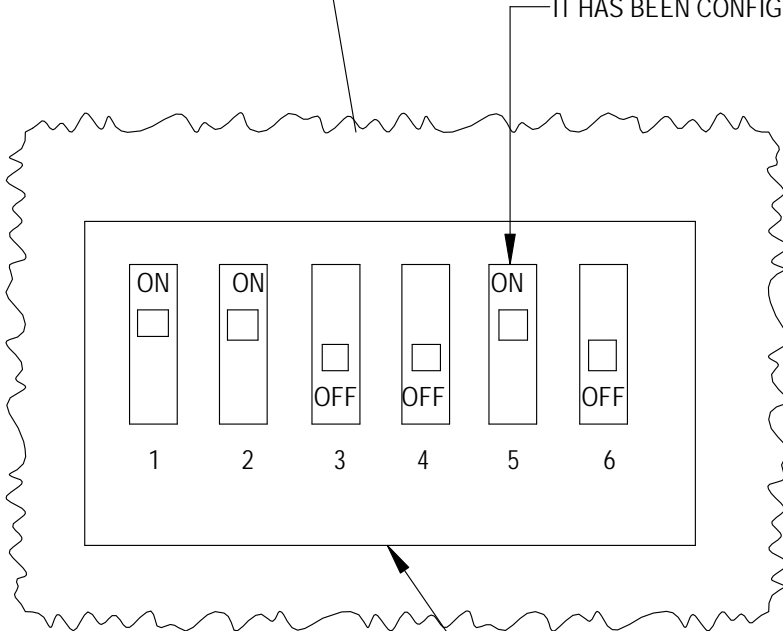
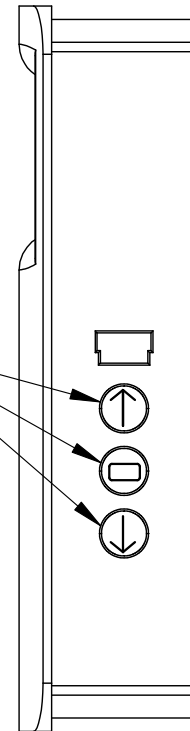

DIP SWITCHES MUST BE
 POSITIONED AS SHOWN
 FOR PROPER OPERATION

Settings	Recommended	Default
RON	Not Used	
ROF	Not Used	
DSP	C	CT
UNI	US	US
COL	700	0
COH	1500	2000
TOL	Not Used	
TOH	Not Used	
BAR	See Instrution with Controller For High Altitude Installations	
CAL	Used for Field Calibration	

MIS-4025 A

GRAPH 1
W3SAC CRV-V5 Ventilation Delivery



GRAPH 2
W42*C CRV-V5 Ventilation Delivery

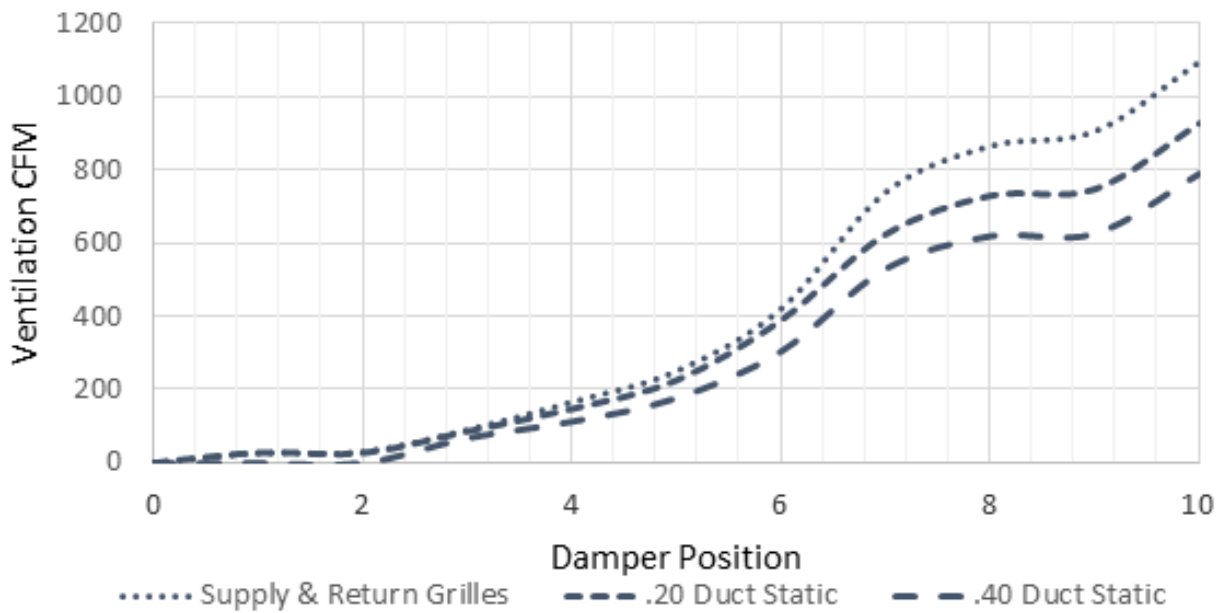

GRAPH 3
W48°C and W4SAC CRV-V5 Ventilation Delivery

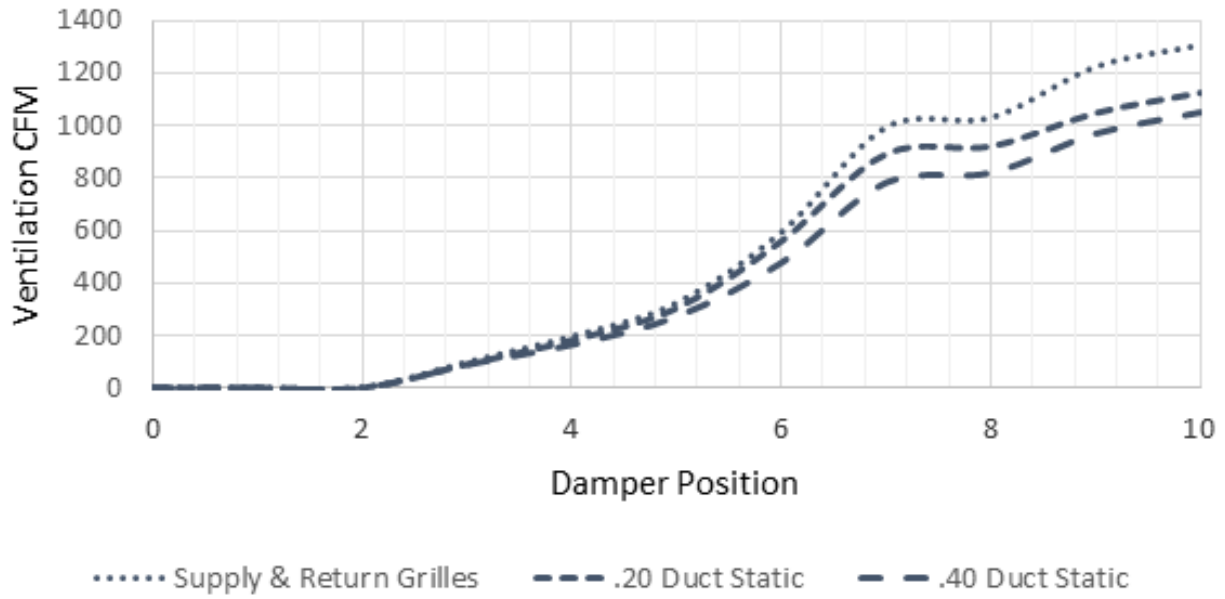

GRAPH 4
W60°C and W5SAC CRV-V5 Ventilation Delivery

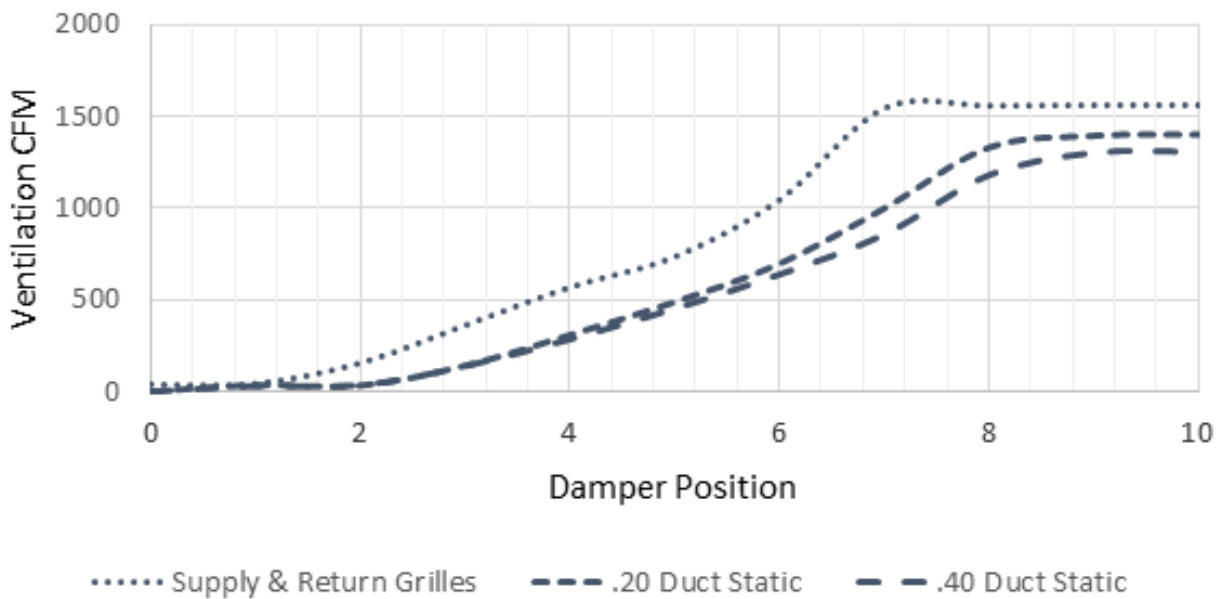

GRAPH 5
W72AC CRV-V5 Ventilation Delivery

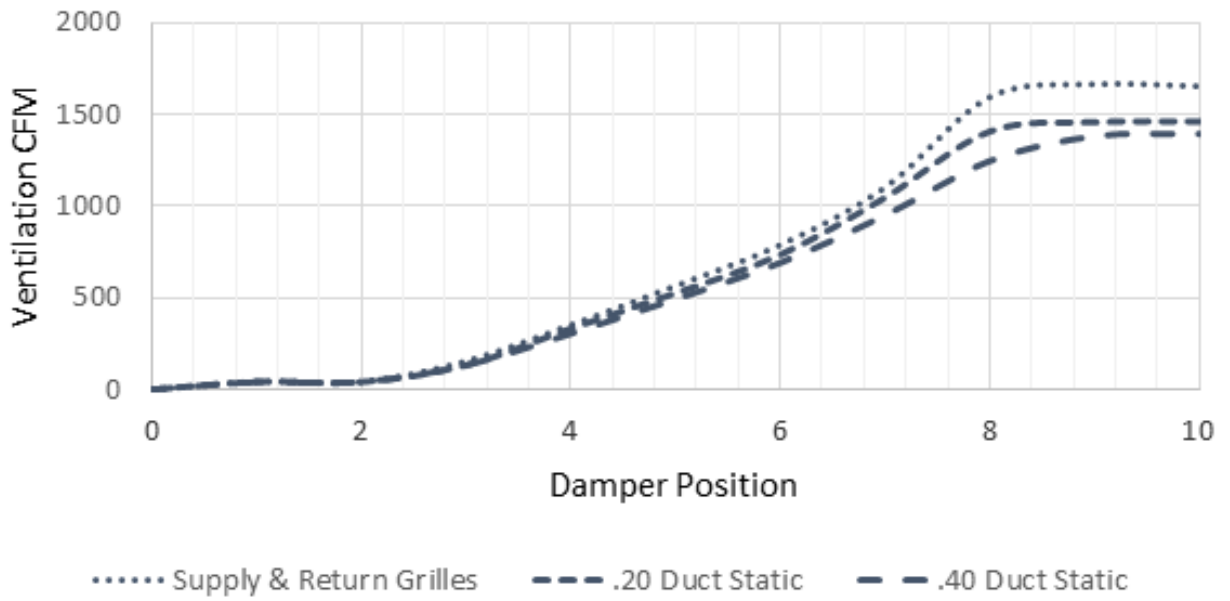

"V" Option CRV Sequence of Operation

The "V" Ventilation option includes a control board with blade positioning potentiometers along with an input for a 2-10V input signal (see Figure 26).

Adjustable potentiometers:

"PP" Potentiometer setting: This potentiometer can be used to adjust the blade setting for outdoor air intake during a pre-purge cycle. The pre-purge cycle time is based on the setting of the pre-purge timer.

"OCC" Potentiometer setting: This potentiometer can be used to adjust the blade setting for outdoor air intake when the "A" terminal is energized on the low voltage terminal strip indicating occupancy.

"Y1" Potentiometer setting: This potentiometer can be used to adjust the blade setting for outdoor air intake when the "Y1" terminal is energized on the low voltage terminal strip indicating 1st stage cooling or Balanced Climate operation. When energized, it overrides the "OCC" potentiometer setting.

"Y2" Potentiometer setting: This potentiometer can be used to adjust the blade setting for outdoor air intake when the "Y2" terminal is energized on the low voltage terminal strip indicating 2nd stage cooling operation. When energized, it overrides the "OCC" and "Y1" potentiometer settings.

Pre-Purge Feature

Pre-purge is used to ventilate a specified CFM amount before occupants enter the room or structure. The control board has a built-in pre-purge timer that can be set to 30, 60 and 90 minute intervals by moving the jumper noted in Figure 17 on page 9. This timer will start when the jumper is installed and the A terminal is energized on the low voltage terminal strip. Blade adjustment can be made on the PP potentiometer. Once the timer has timed out, the board will default to the occupied setting and this blade position can be adjusted on the OCC potentiometer. If the timer is set to 0 (off—shipped position), the occupied setting is instantaneous and the pre-purge setting (PP) is no longer in the sequence.

Occupied Setting

Occupied is used to ventilate a specified CFM amount when occupants enter the room or structure. The control board will energize the occupied setting after the pre-purge cycle, or if pre-purge is disabled immediately when the A terminal is energized on the low voltage strip. Blade adjustment can be made on the OCC potentiometer.

Y1 Setting

Single Stage Compressor

Y1 is used to ventilate a specified CFM amount when Y1 cooling is energized. If Balanced Climate operation is used, the Y1 setting should be set to a blade setting

FIGURE 26
CRV Control Board

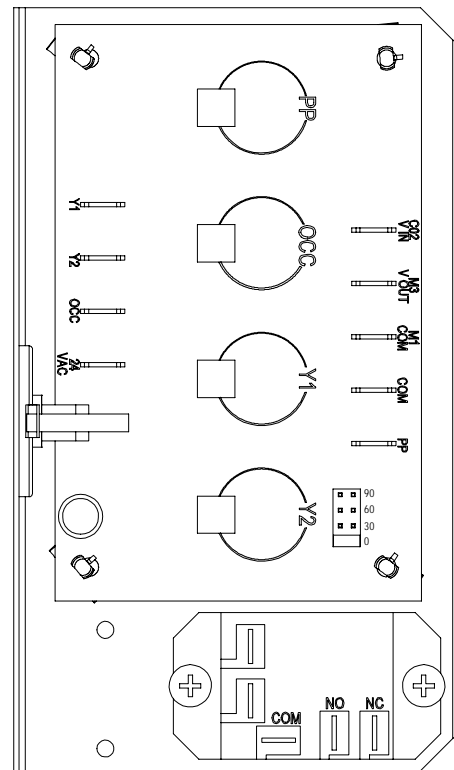

that will allow additional outdoor intake air. The control board will energize the Y1 setting when Y1 is energized on the low voltage strip. Blade adjustment can be made on the Y1 potentiometer. This potentiometer setting overrides the OCC occupied setting.

2-Stage Compressor

Y1 is used to ventilate a specified CFM amount when Y1 or Y2 cooling is energized. If part load or Balanced Climate operation is used, the Y1 setting should be set to a blade setting that will allow additional outdoor intake air. The control board will energize the Y1 setting when Y1 or Y2 is energized on the low voltage strip. Blade adjustment can be made on the Y1 potentiometer. This potentiometer setting overrides the OCC occupied setting.

Y2 Setting

Single Stage Compressor

Y2 is used to ventilate a specified CFM amount when Y2 cooling is energized. The control board will energize the Y2 setting when Y2 is energized on the low voltage strip. The blade setting for the Y2 potentiometer must be set to match the occupied setting (OCC potentiometer) in order to bring in the same amount of outdoor air when non-Balanced Climate cooling occurs. Blade adjustment can be made on the Y2

potentiometer. This potentiometer setting overrides the OCC occupied and the Y1 setting.

2-Stage Compressor

Y2 is used to ventilate a specified CFM amount when Y3 cooling is energized. The control board will energize the Y2 setting when Y3 is energized on the low voltage strip. The blade setting for the Y2 potentiometer must be set to match the occupied setting (OCC potentiometer) in order to bring in the same amount of outdoor air when non-Balanced Climate cooling occurs. Blade adjustment can be made on the Y2 potentiometer. This potentiometer setting overrides the OCC occupied and the Y1 setting.

2-10V Operation

A CO₂ sensor or other device sending a 2-10V signal can be used to control the damper motor. Two control methods are available to control the damper motor:

- Method 1: The control board will accept a 2-10VDC signal with a resistive load greater than 5000 ohms. Bard CO₂ sensor part #8403-056 can be used when the 2-10V output is connected to terminal 4 on the unit low voltage terminal strip. The occupied OCC potentiometer setting must be set to the off position for total modulation. The OCC potentiometer can be used to maintain a minimum blade position when A is energized.
- Method 2: The damper motor will accept a 2-10VDC signal with a resistive load less than 5000 ohms. This method involves bypassing the control board and powering the motor directly from the device providing the 2-10VDC modulating signal. The gray wire from pin 4 on the 12 pin connector (2-10V IN on control board) must be spliced with the white wire ran to the damper motor (2-10V OUT on control board).

During 2-10VDC operation with A energized and pre-purge timed operation active, DC voltage signaling occupancy from a source such as a CO₂ sensor will increase ventilation amounts as needed.

TABLE 1
Unit Operation with V (Variable CRV) Ventilation Option for Single Stage Compressor Units

Unit Operation	Occ. Signal	Low Voltage 24VAC							Speed Taps			Fan Speed	Comp. Oper.	Damper Pot.
		G	Y1	Y2	W1	W2	A	D	1	2	3-4-5 ¹			
Fan Only	Yes	X					X		X			Vent	Off	PP/OCC
Fan Only	No	X							X			Vent	Off	Closed
BC Cooling ²	Yes		X				X		X	X		B Climate	On	Y1
BC Cooling ²	No		X						X	X		B Climate	On	Closed
Full Load Cool	Yes		X	X			X		X	X	X	Lo/Med/Hi	On	Y2
Full Load Cool	No		X	X					X	X	X	Lo/Med/Hi	On	Closed
1st Stage Heat	Yes				X		X				X	Lo/Med/Hi	Off	Y2
1st Stage Heat	No				X						X	Lo/Med/Hi	Off	Closed
2nd Stage Heat	Yes				X	X	X				X	Lo/Med/Hi	Off	Y2
2nd Stage Heat	No				X	X					X	Lo/Med/Hi	Off	Closed
Dehumidify ³	Yes						X	X	X	X		B Climate	On	Y1
Dehumidify ³	No							X	X	X		B Climate	On	Closed

BC and B Climate – Balanced Climate

- ¹ Fan speed is selectable through the blower speed control terminal block. LO (default), MED or HI speeds can be used.
- ² Y1 and Y2 jumper must be removed on low voltage terminal block connections and 2 stage thermostat must be utilized.
- ³ Dehumidification operation is disabled when a call for heating or cooling occurs. Unit runs at Balanced Climate speed during dehumidification operation.

TABLE 2
Unit Operation with V (Variable CRV) Ventilation Option for 2-Stage Compressor Units

Unit Operation	Occ. Signal	Low Voltage 24VAC								Speed Taps			Fan Speed	Comp. Oper.	Damper Pot.
		G	Y1	Y2	Y3	W1	W2	A	D	1	2	3-4-5 ¹			
Blower Only	Yes	X						X		X			Vent	Off	PP/OCC
Blower Only	No	X								X			Vent	Off	Closed
Part Load Cool	Yes	X	X					X		X	X		B Climate	On	Y1
Part Load Cool	No	X	X							X	X		B Climate	On	Closed
BC Cooling ²	Yes	X	X	X				X		X	X		B Climate	On	Y1
BC Cooling ²	No	X	X	X						X	X		B Climate	On	Closed
Full Load Cool	Yes	X	X	X	X			X		X	X	X	Lo/Med/Hi	On	Y2
Full Load Cool	No	X	X	X	X					X	X	X	Lo/Med/Hi	On	Closed
1st Stage Heat	Yes					X		X				X	Lo/Med/Hi	Off	Y2
1st Stage Heat	No					X						X	Lo/Med/Hi	Off	Closed
2nd Stage Heat	Yes					X	X	X				X	Lo/Med/Hi	Off	Y2
2nd Stage Heat	No					X	X					X	Lo/Med/Hi	Off	Closed
Dehumidify ³	Yes							X	X	X	X		B Climate	On	Y1
Dehumidify ³	No								X	X	X		B Climate	On	Closed

BC and B Climate – Balanced Climate

- ¹ Fan speed is selectable through the blower speed control terminal block. LO (default), MED or HI speeds can be used.
- ² Y2 and Y3 jumper must be removed on low voltage terminal block connections and 3 stage thermostat must be utilized.
- ³ Dehumidification operation is disabled when a call for heating or cooling occurs. Unit runs at Balanced Climate speed during dehumidification operation.

FIGURE 27
Call for Ventilation With or Without Compressor Operation

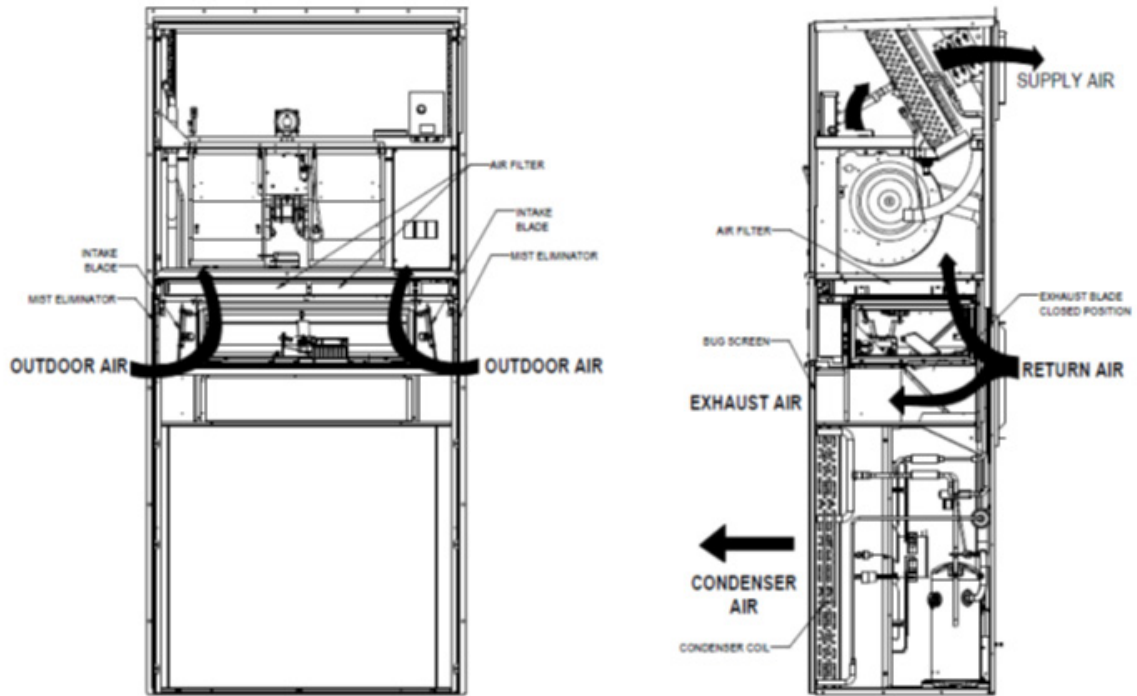

MIG-4036

FIGURE 28
Call for Compressor or Fan Only with Ventilation Off

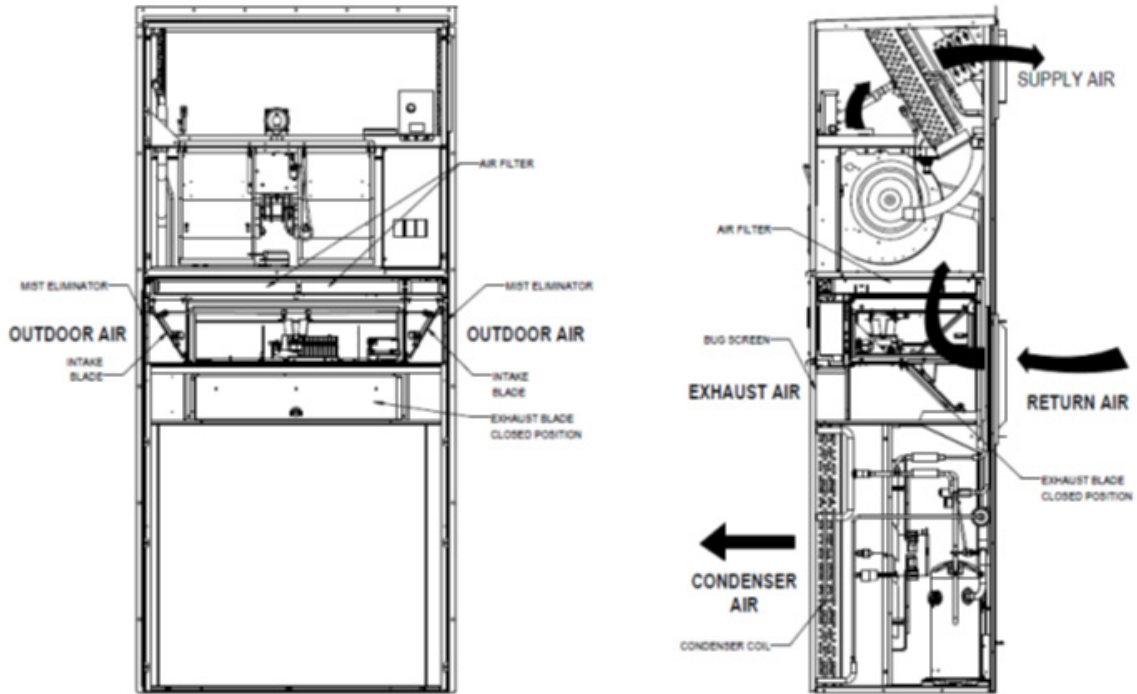

MIG-4037

FIGURE 29
Lubrication Points

