REPLACEMENT PARTS MANUAL

WALL MOUNTED PACKAGE HEAT PUMPS

Models: **WH262**
WH311

General Notes

- Revised and/or additional pages may be issued from time to time.
- A complete and current manual consists of pages shown in the following contents section.

Important

- Contact the installing and/or local Bard distributor for all parts requirements. Make sure you have the complete model and serial number available from the unit rating plates.

Contents

<i>Description</i>	<i>Page</i>
Cabinet Components	
♦ Exploded View	1
♦ Usage List	2
Functional Components	
♦ Exploded View	3
♦ Usage List	4
Control Panel	
♦ Layout	5
♦ Usage List	6
Blower Assembly	
♦ Exploded View	7
♦ Usage List	7



BARD MANUFACTURING COMPANY
Bryan, Ohio 43506

Since 1914...Moving ahead, just as planned.

Manual: 2110-527D
Supersedes: 2110-527C
File: Tab 17
Date: 09-09-04





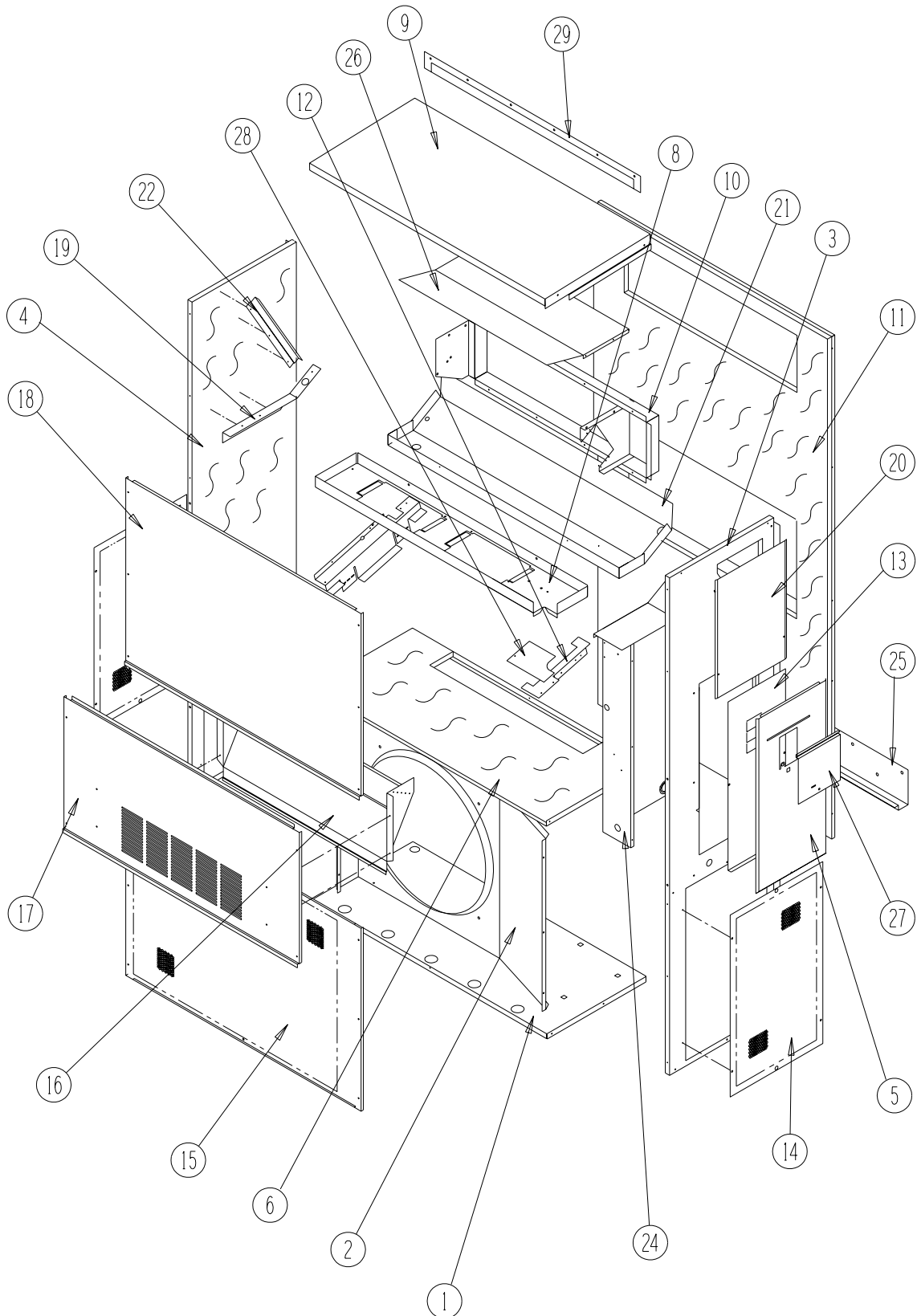





CLIMATE CONTROL SOLUTIONS

CABINET COMPONENTS



SEXP-318

CABINET COMPONENTS

Drawing No.	Part No.	Description	ALL
1	S127-298 	Lower Base	X
2	125-028 	Fan Shroud	X
3	S500-228-* ①	Right Side	X
4	S500-229-* ①	Left Side	X
5	S533-161-* ①	Control Panel Cover (Outer)	X
6	S520X181	Condenser Partition	X
8	121X182	Blower Partition	X
9	S506-130 	Top	X
10	S111X030 	Outlet Airframe Assembly	X
11	S508-088	Back	X
12	113X195	Filter Bracket	2
13	S133-104 	Control Panel Cover (Inner)	X
14	118-056-* ① 	Side Grille	2
15	118-059-* ①	Condenser Grille	X
16	BFAD-3	Fresh Air Damper Assembly	X
17	S552-206-* ①	Service Door	X
18	S514-072-* ①	Upper Front	X
19	105-850 	Left Side Support	X
20	143-034-* ① 	Right Side cover Plate (Outer)	X
21	S123-078 	Drain Pan	X
22	147-044	Left Evaporator Support	X
24	Control Panel Assembly	See Control Panel Assembly Drawing and Parts List	X
25	113-140	Bottom Mounting Bracket	X
26	135-123 	Heat Shield	X
27	S153-218 	Disconnect Access Door	X
28	137-259	Fill Plate	X
29	113-149-* ①	Top Rain Flashing	X

① Exterior cabinet parts are manufactured with various paint color options. To insure that you receive the proper paint color, you must include the complete model and serial number of the unit for which cabinet parts are being ordered.

FUNCTIONAL COMPONENTS

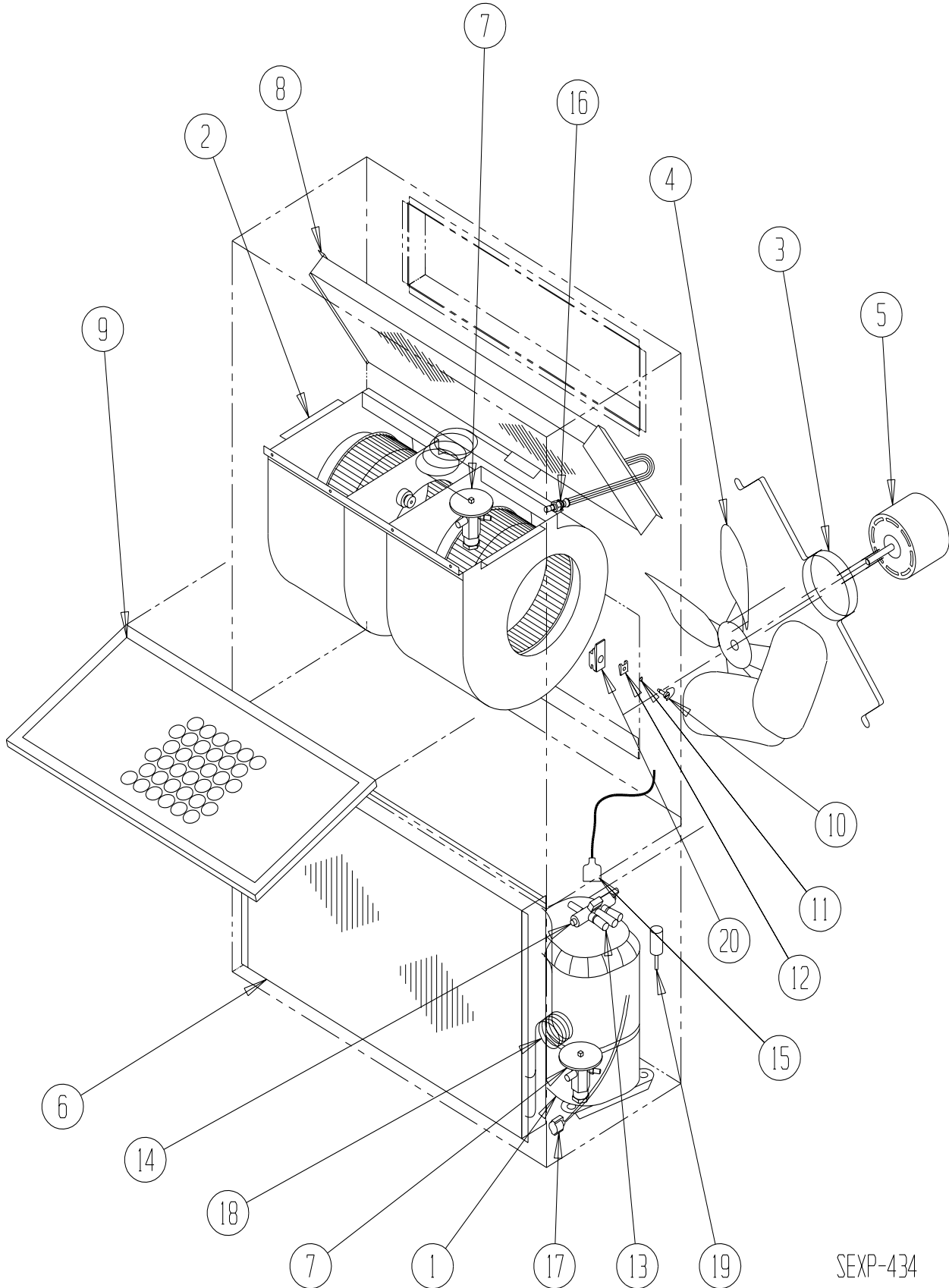

SEXP-434

FUNCTIONAL COMPONENTS

Drawing			WH262-A	WH262-B	WH262-C	WH311-A	WH311-B	WH311-C
No.	Part No.	Description						
1	8000-233	Compressor				X		
1	8000-258	Compressor	X					
1	8000-234	Compressor					X	
1	8000-235	Compressor						X
1	8000-231	Compressor		X				
1	8000-232	Compressor			X			
2	S900-246	Blower Assembly	X	X		X	X	
2	S900-247	Blower Assembly			X			X
3	8200-001	Fan Motor Mount	X	X	X	X	X	X
4	5151-050	Fan Blade	X	X	X	X	X	X
5	8103-013	Condenser Motor	X	X		X	X	
5	8103-020	Condenser Motor			X			X
6	5051-112	Condenser Coil	X	X	X	X	X	X
7	5651-138	Cooling & Heating TXV	2	2	2	2	2	2
8	5060-101	Evaporator Coil	X	X	X	X	X	X
9	7004-019	Air Filter 1" Throwaway	X	X	X	X	X	X
9	7003-031	Air Filter 1" Washable ①	X	X	X	X	X	X
9	7004-026	Air Filter 2" Pleated ①	X	X	X	X	X	X
10	1171-022	1/4 Turn Fastener	X	X	X	X	X	X
11	1171-024	1/4 Turn Retainer	X	X	X	X	X	X
12	1171-023	1/4 Receptacle	X	X	X	X	X	X
13	5650-039	Reversing Valve	X	X	X	X	X	X
14	5650-042	Rev. Valve Solenoid, Red Casing (Ranco)	X	X	X	X	X	X
14	5650-043	Rev. Valve Solenoid, Black Casing (Wilspec)	X	X	X	X	X	X
15	5650-037	Molded Plug 3/6" Lead	X	X	X	X	X	X
16	800-0292	Cooling Distributor	X	X	X	X	X	X
17	8408-027	Defrost Sensor	X	X	X	X	X	X
18	800-0293	Heating Distributor	X	X	X	X	X	X
19	1804-0106	High Pressure Switch (Solder) ①	X	X	X	X	X	X
20	1171-044	Locking Latch	X	X	X	X	X	X
NS	1804-0107	Low Pressure Switch (Flare) ①	X	X	X	X	X	X
NS	1804-0108	Low Ambient Control (Flare) ①	X	X	X	X	X	X

NS – Not Shown

① – Optional

CONTROL PANEL

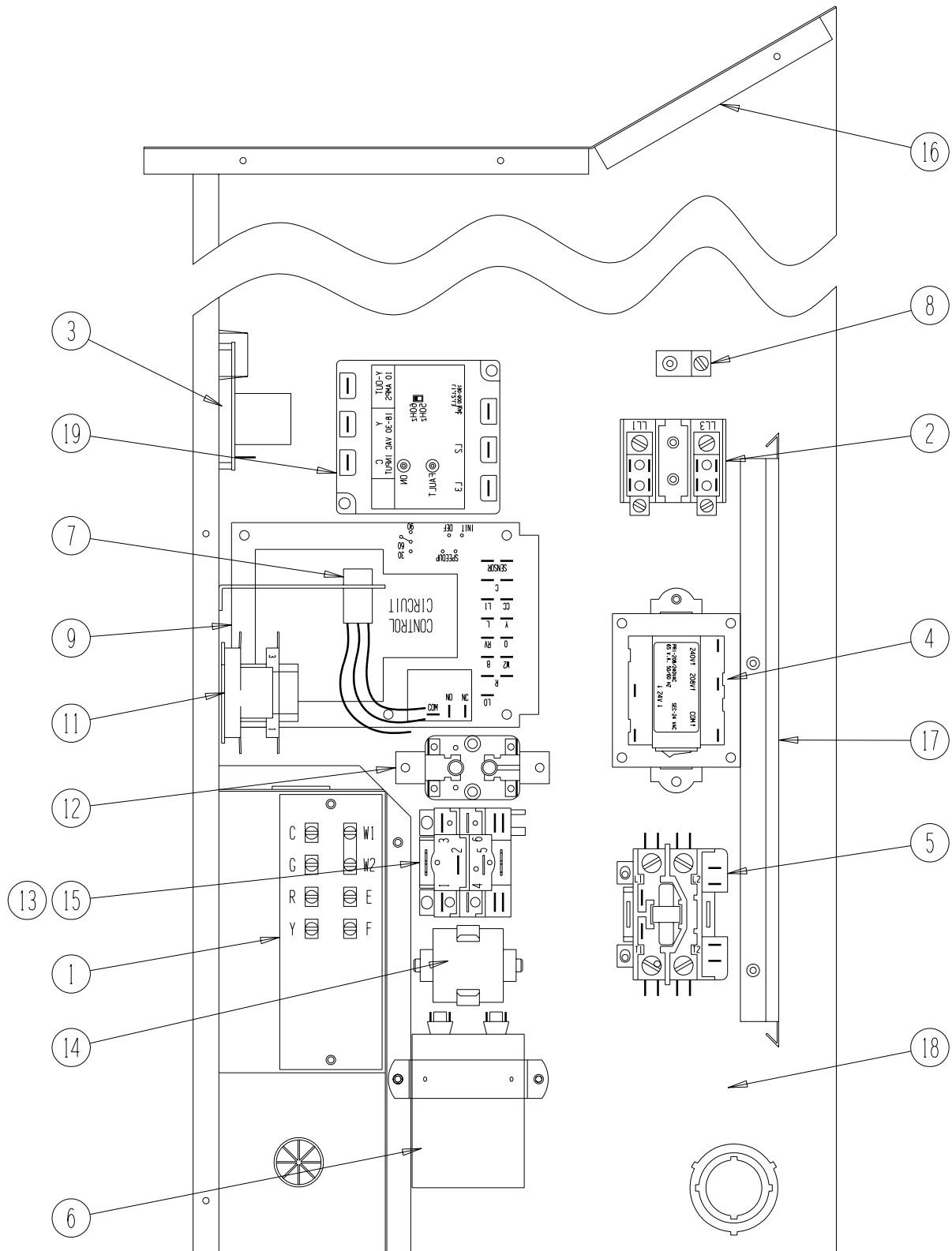

SEXP-320

CONTROL PANEL

Drawing No.	Part No.	Description	WH262-A	WH262-B	WH262-C	WH311-A	WH311-B	WH311-C
1	8607-019	Low Voltage Terminal Strip	X	X	X	X	X	X
2	8607-013	Terminal Block 2 Pole	X			X		
2	8607-014	Terminal Block 3 Pole		X	X		X	X
2	8607-015	Phelon Insulator			X			X
3	8201-056	Blower Control	X	X		X	X	
3	8201-032	Blower Relay			X			X
4	8407-048	Transformer	X	X		X	X	
4	8407-050	Transformer			X			X
5	8401-007	Compressor Contactor	X			X		
5	8401-002	Compressor Contactor		X	X		X	X
6	8552-048	Compressor Capacitor	X					
6	8552-050	Compressor Capacitor				X		
6	8552-002	Outdoor Motor Capacitor		X	X		X	X
7	3000-971	Six Pin Connector	X	X	X	X	X	X
8	8611-006	Ground Terminal	X	X	X	X	X	X
9	8201-069	Heat Pump Control Board	X	X	X	X	X	X
11	8201-065	Low Pressure Bypass (TDR) ①	X	X	X	X	X	X
12	8201-008	Low Ambient Bypass Relay ①	X	X	X	X	X	X
13	8607-017	LAC Terminal Block ①	X	X	X	X	X	X
14	8551-005	Start Device ①	X			X		
15	8201-032	Outdoor Fan Relay			X			X
16	S517-137	Control Panel Top	X	X	X	X	X	X
17	135-122	Wire Shield	X	X	X	X	X	X
18	117-123	Control Panel	X	X	X	X	X	X
19	8201-085	Phase Monitor		X	X		X	X
NS	4096-115	Wiring Diagram	X			X		
NS	4096-219	Wiring Diagram		X			X	
NS	4096-319	Wiring Diagram			X			X
NS	8615-038	Circuit Breaker 35A 2 Pole (0Z)	X			X		
NS	8615-051	Circuit Breaker 25A 3 Pole (0Z)		X			X	

NS – Not Shown

① – Optional

BLOWER ASSEMBLY

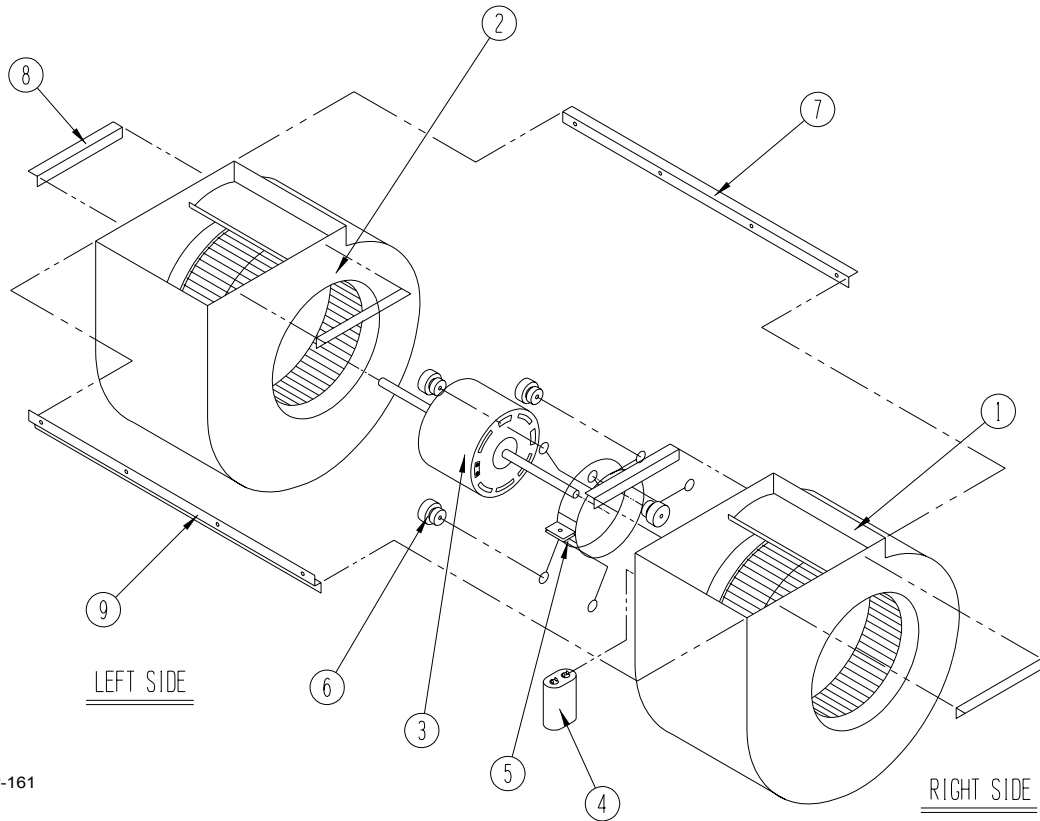

SEXP-161

Dwg. No.	Part No.	Description	900-246	900-247
1	5152-051	Housing, Wheel and Cutoff (CW)	X	X
2	5152-052	Housing, Wheel and Cutoff	X	X
3	8103-025	Blower Motor (230/208)	X	
3	8103-026	Blower Motor (460)		X
4	8552-005	Capacitor	X	
4	8552-004	Capacitor		X
5	8200-031	Motor Mount	X	X
6	5451-011	Grommets	6	6
7	105-870	Back Brace	X	X
8	104-868	Side Angle	4	4
9	103-401	Front Brace	X	X